



SC6 drive controller Manual

en-US
11/2024
ID 442790.09

Table of contents

- Table of contents 2**
- 1 Foreword 10**
- 2 User information 11**
 - 2.1 Storage and transfer 11
 - 2.2 Described product 11
 - 2.3 Directives and standards 11
 - 2.4 UL file number 12
 - 2.5 Timeliness 12
 - 2.6 Original language 12
 - 2.7 Limitation of liability 12
 - 2.8 Formatting conventions 13
 - 2.8.1 Display of warning messages and information 13
 - 2.8.2 Markup of text elements 14
 - 2.8.3 Mathematics and formulas 14
 - 2.8.4 Conventions for cables 15
 - 2.9 Marks and test symbols 15
 - 2.10 Trademarks 16
- 3 Safety notes 17**
 - 3.1 Qualified personnel 17
 - 3.2 Intended use 17
 - 3.3 Transport and storage 18
 - 3.4 Operational environment and operation 18
 - 3.5 Working on the machine 19
 - 3.6 Installation 19
 - 3.7 Electrical connection 20
 - 3.8 Ensuring traceability 20
 - 3.9 Decommissioning 20
 - 3.10 Disposal 21
 - 3.11 Firefighting 21
- 4 Security 22**
- 5 UL-compliant use 25**
- 6 System design 27**
 - 6.1 Hardware components 28
 - 6.1.1 Drive controllers 28
 - 6.1.2 Operating motors, encoders and brakes 32
 - 6.1.3 Accessories 33

6.2	Software components	39
6.2.1	Project configuration and parameterization	39
6.2.2	Applications	39
7	Technical data	40
7.1	Drive controllers	40
7.1.1	General technical data	40
7.1.2	Electrical data	41
7.1.3	Cycle times	49
7.1.4	Derating	50
7.1.5	Dimensions	52
7.1.6	Weight	52
7.2	DC link connection	53
7.2.1	General technical data	53
7.2.2	Assignment of DL6B to SC6	54
7.2.3	Dimensions	55
7.2.4	Weight	55
7.2.5	Copper rails	56
7.3	SR6 safety module	56
7.4	Operating motors	57
7.5	Evaluable encoders	58
7.5.1	Overview	58
7.5.2	Signal transmission	59
7.5.3	X4: Encoder	59
7.5.4	X101: Encoder	63
7.5.5	X103: Encoder	63
7.6	Controllable brakes	64
7.7	Evaluable motor temperature sensors	64
7.8	Braking resistor	65
7.8.1	Tubular fixed resistor FZMU, FZZMU	65
7.8.2	GVADU, GBADU flat resistor	67
7.9	Choke	69
7.9.1	TEP output choke	69
8	Project configuration	71
8.1	Drive controllers	71
8.2	DC link connection	71
8.2.1	Information on design and operation	72
8.2.2	Design	73
8.3	Mixed operation	75
8.4	Motor	76
8.5	Choke	77
8.5.1	TEP output choke	77

- 9 Storage..... 80**
 - 9.1 Drive controllers 80
 - 9.1.1 Annual reforming..... 80
 - 9.1.2 Reforming before commissioning..... 81
- 10 Installation..... 82**
 - 10.1 Basic assembly instructions 82
 - 10.1.1 Drive controllers 82
 - 10.1.2 Braking resistor 83
 - 10.1.3 Choke 83
 - 10.2 Minimum clearances 84
 - 10.3 Drilling diagrams and bore dimensions 85
 - 10.3.1 Drive controllers 85
 - 10.3.2 Braking resistor 86
 - 10.3.3 Choke 87
 - 10.4 Length of copper rails 88
 - 10.5 Installing the drive controller without a rear section module..... 89
 - 10.6 Installing the DC link connection 90
 - 10.7 Mounting the drive controller on the rear section module 93
- 11 Connection..... 96**
 - 11.1 Line routing..... 96
 - 11.2 Protective measures..... 96
 - 11.2.1 Power supply with DC link connection 96
 - 11.2.2 Line fuse..... 97
 - 11.2.3 Grid connection for DC link connection..... 99
 - 11.2.4 Residual current protective device 100
 - 11.2.5 Protective grounding 101
 - 11.2.6 EMC recommendations 104
 - 11.3 Drive controllers 105
 - 11.3.1 Overview..... 105
 - 11.3.2 X2A: Brake or digital output 106
 - 11.3.3 X2A: Motor temperature sensor A 107
 - 11.3.4 X2B: Brake or digital output..... 107
 - 11.3.5 X2B: Motor temperature sensor B 107
 - 11.3.6 X4A: Encoder A 108
 - 11.3.7 X4B: Encoder B..... 115
 - 11.3.8 X9: Ethernet service interface 116
 - 11.3.9 X10: 400 V supply 117
 - 11.3.10 X11: 24 V supply – Control unit 118
 - 11.3.11 X12 (SR6 option): Safety technology 119
 - 11.3.12 X20A: Motor A 120
 - 11.3.13 X20B: Motor B 121
 - 11.3.14 X21: Braking resistor..... 121

11.3.15	X22: DC link connection	122
11.3.16	X101: DI1 – DI4	123
11.3.17	X103: DI6 – DI9	125
11.3.18	X200, X201: EtherCAT	127
11.3.19	X200, X201: PROFINET	128
11.3.20	X300: 24 V supply – Brakes or digital outputs	129
11.3.21	X700: SD slot	130
11.3.22	Connecting a drive controller	130
11.4	Braking resistor.....	132
11.4.1	FZMU, FZZMU connection description	133
11.4.2	GVADU, GBADU connection description	133
11.5	Output choke.....	134
11.5.1	Connection description.....	134
11.6	Cables	135
11.6.1	Power cables.....	136
11.6.2	Encoder cables.....	140
11.6.3	One Cable Solution	153
12	Operation.....	155
12.1	S1 operating button of the drive controller	155
13	What you should know before commissioning	157
13.1	DS6 program interface	157
13.2	Meaning of parameters.....	159
13.2.1	Parameter groups	159
13.2.2	Parameter types and data types.....	160
13.2.3	Parameter types	161
13.2.4	Parameter structure	161
13.2.5	Parameter visibility	162
13.3	Signal sources and process data mapping	163
13.4	Non-volatile memory.....	163
14	Commissioning.....	164
14.1	Initiating the project.....	165
14.1.1	Projecting the drive controller and axis.....	165
14.1.2	Configuring safety technology.....	166
14.1.3	Creating other modules and drive controllers.....	166
14.1.4	Projecting the module	167
14.1.5	Projecting the project	167
14.2	Mapping the mechanical axis model	168
14.2.1	Parameterizing the motor	168
14.2.2	Parameterizing the axis model	169
14.3	Transmitting and saving a configuration	174
14.3.1	Transmitting the configuration.....	174
14.3.2	Saving the configuration.....	176

14.4	Testing the configuration	177
14.5	Preparing for a case of service	178
14.6	Testing the safety configuration.....	178
14.7	Safety technology for series machines.....	178
15	Communication.....	179
15.1	Direct connection	179
15.1.1	Starting a drive controller in emergency operation	180
15.2	Fieldbus	180
16	Optimizing the control cascade	181
16.1	Structure of the control cascade	181
16.2	General procedure	182
16.3	Example project.....	183
16.3.1	Scope settings.....	183
16.3.2	Jog settings	184
16.4	Schematic sequence.....	185
16.5	Current controller – Notes	186
16.6	0: Default Lean motor settings – Speed estimation	186
16.7	1: Velocity controller – Actual velocity filters.....	187
16.8	2: Velocity controller – Proportional coefficient	189
16.9	3: Velocity controller – Integral coefficient	193
16.10	Velocity controller – Summary	194
16.11	4: Position controller – Proportional coefficient	195
16.12	5: Position controller – Velocity controller feedforward control	196
16.13	Position controller – Summary	197
16.14	Special cases.....	197
16.14.1	Current controller – Motor reaches saturation	197
16.14.2	Velocity controller – High set torque.....	198
16.14.3	Position controller – Friction or play	198
16.14.4	Position controller – Poor resolution.....	198
17	Brake	199
17.1	Activating the brake	199
17.2	Calibrate brake	200
17.3	Testing a functional brake	201
17.4	Bedding in the brake	202
17.5	Bedding in brake 2.....	203
17.6	More about the brake?	204
17.6.1	Direct and indirect brake connection	204
17.6.2	Release override	204

17.6.3	Internal and external brake control.....	205
17.6.4	Brake release time and brake engaging time	214
17.6.5	Time between 2 release processes.....	215
17.6.6	Calibrating the brake	215
17.6.7	Brake test.....	217
17.6.8	Torque calculation	218
17.6.9	Bedding in the brake.....	220
17.6.10	Brake connection as digital output.....	221
17.6.11	Special case of load changes when the power unit is switched off	221
18	Predictive Maintenance	222
18.1	Legal disclaimer	222
18.2	Displaying the state	223
18.3	Configuring Predictive Maintenance	224
18.4	Sending the load matrix.....	227
18.5	Exporting the load matrix	229
18.6	Resetting the load matrix	229
18.7	Displaying a 3D load matrix	230
18.8	Resetting the life performance indicator	230
18.9	Information on activation, operation and replacement.....	231
18.10	More about Predictive Maintenance?.....	232
18.10.1	Load matrix.....	232
18.10.2	Life performance indicator	241
18.10.3	Update and storage cycles.....	242
18.10.4	Recommendation for geared motor replacement	243
18.10.5	Reading out and transmitting the load matrix	243
19	Diagnostics.....	245
19.1	Drive controllers	245
19.1.1	Drive controller state.....	246
19.1.2	State of the fieldbus and safety technology	249
19.1.3	Service network connection	254
19.1.4	Fieldbus network connection	255
19.1.5	Events	257
19.2	SX6 safety module	311
19.2.1	Parameters	311
19.2.2	Error codes.....	311
19.3	Acknowledging faults	316
20	Analysis.....	317
20.1	Scope and multi-axis scope	318
20.1.1	Scope settings.....	321
20.1.2	Image editor	326
20.1.3	Frequency analysis.....	329

- 20.2 Scope image 330
 - 20.2.1 Creating a scope image..... 330
 - 20.2.2 Combining scope images 332
 - 20.2.3 Creating a direct image..... 332
- 20.3 Multi-axis scope images 334
 - 20.3.1 Requirements 334
 - 20.3.2 Creating a multi-axis scope image 335
- 20.4 Parameters 337
- 21 Replacement 338**
 - 21.1 Notes on the safety configuration 338
 - 21.2 Replacing the drive controller 338
 - 21.3 Commissioning the new drive controller after replacing the device..... 340
 - 21.4 Replacing the SD card 342
 - 21.5 Updating firmware 342
 - 21.5.1 Updating firmware using DS6 342
 - 21.5.2 Updating firmware using an SD card 345
 - 21.6 Changing a fieldbus variant 346
 - 21.7 Motor replacement 347
- 22 Service 348**
 - 22.1 Information about the product 348
 - 22.2 STOBER electronics service..... 348
 - 22.3 Reverse documentation 348
 - 22.3.1 Creating reverse documentation 349
 - 22.3.2 Deleting reverse documentation 350
- 23 Appendix..... 351**
 - 23.1 Weights..... 351
 - 23.2 Terminal specifications..... 352
 - 23.2.1 Overview 352
 - 23.2.2 BCF 3,81 180 SN 353
 - 23.2.3 BLDF 5.08 180 SN 353
 - 23.2.4 FMC 1,5 -ST-3,5 354
 - 23.2.5 G 10/2 354
 - 23.2.6 GFKC 2,5 -ST-7,62 355
 - 23.2.7 GFKIC 2.5 -ST-7.62 355
 - 23.2.8 ISPC 5 -STGCL-7,62 356
 - 23.2.9 ISPC 16 -ST-10,16 356
 - 23.2.10 SPC 5 -ST-7,62 357
 - 23.3 Wiring examples 358
 - 23.3.1 Stand-alone operation with direct brake control 358
 - 23.3.2 DC link connection 359

23.4	Order overview of the hardware components.....	360
23.5	SSI encoders	361
23.5.1	SSI: Evaluation at X4 with free setting (H00 = 78)	361
23.5.2	SSI: Evaluation at X4 with fixed setting (H00 = 65)	362
23.6	Commutation finding.....	364
23.7	Device addressing.....	365
23.8	DriveControlSuite	366
23.8.1	System requirements.....	366
23.8.2	Installation types	366
23.8.3	Installing DriveControlSuite	367
23.8.4	Communication requirements.....	368
23.8.5	Establishing a connection	369
23.8.6	Configuring virtual machines	375
23.8.7	Updates	375
23.8.8	Script mode.....	376
23.8.9	Simple Network Time Protocol (SNTP)	399
23.8.10	Security log	400
23.9	Detailed information	402
23.10	Symbols in formulas	404
23.11	Abbreviations	406
24	Contact	408
24.1	Consultation, service and address.....	408
24.2	Your opinion is important to us.....	408
24.3	Close to customers around the world	409
	Glossary	410
	List of figures.....	419
	List of tables.....	422

1 Foreword

The stand-alone SC6 drive controller enables extremely economical system designs due to its integrated power supply and slim design. The SC6 series is ideal for combination with the innovative Lean motor – for example, for energy-efficient transport systems. Another benefit is that the Lean motor and SC6 run completely without an encoder! However, the SC6 can also be used in combination with asynchronous motors or synchronous servo motors with encoders (e.g. the EZ series). SC6 is available in three sizes with a nominal output current of up to 19 A: Sizes 0 and 1 as a double-axis controller, size 2 as a single-axis controller.

Features

- Sensorless position control of Lean motors
- Control of rotary synchronous servo motors and asynchronous motors
- Control of linear and torque motors
- One Cable Solution EnDat 3
- Electronic motor nameplate via EnDat encoder interfaces
- Integrated EtherCAT or PROFINET communication
- STO safety technology using terminals or STO and SS1 using FSoE or PROFIsafe: SIL 3, PL e (Cat. 4)
- Extended safety technology (SS1, SS2, SLS,...) using FSoE
- Integrated brake control
- Single-ended nominal power consumption on double-axis controllers for operation of motors with different power
- Energy supply through direct power feed-in
- Flexible DC link connection for multi-axis applications

2 User information

This documentation covers the SC6 drive controller. You will receive support for the assembly of the individual modules along with the associated components that you will need to operate the drive controllers in the control cabinet.

You will also find information on wiring the modules correctly and checking their functionality in the group with an initial test.

Combinations with other 6th generation STOBER drive controllers are possible under certain boundary conditions.

More detailed information on project configuration, diagnostics and service are additional topics covered in this manual.

2.1 Storage and transfer

As this documentation contains important information for handling the product safely and efficiently, it must be stored in the immediate vicinity of the product until product disposal and be accessible to qualified personnel at all times.

Also pass on this documentation if the product is transferred or sold to a third party.

2.2 Described product

This documentation is binding for:

Drive controllers of the SC6 series in conjunction with the DriveControlSuite (DS6) software in V 6.6-B or higher, PASmotion Safety Configurator in V 1.5.0 or higher and associated firmware in V 6.6-B or higher.

Type		ID No.
Drive controller	SC6A062	56690
	SC6A162	56691
	SC6A261	56692

Tab. 1: Described product types, SC6 drive controllers

2.3 Directives and standards

The following European directives and standards are relevant to the drive controllers:

- Directive 2006/42/EC – Machinery Directive
- Directive 2014/30/EU – EMC Directive
- Directive 2011/65/EU – RoHS Directive
- Directive 2009/125/EC – Ecodesign Directive
- EN IEC 61800-3:2018
- EN 61800-5-1:2007 + A1:2017
- EN 61800-5-2:2017
- EN IEC 63000:2018
- EN ISO 13849-1:2015

Subsequent references to the standards do not specify the respective year in order to improve readability.

2.4 UL file number

cULus-certified devices with corresponding test symbols meet the requirements of the standards UL 61800-5-1 and CSA C22.2 No. 274.

Under the file number specified in the following table, you can find the product in the online database of Underwriter Laboratories (UL):

<https://iq2.ulprospector.com>

Type		File number	UL Category Control Number		Certification
			America	Canada	
Drive controller	SC6A062	E189114	NMMS	NMMS7	cULus
	SC6A162				
	SC6A261				
Braking resistors	FZMU, FZZMU	E212934	NMTR2	NMTR8	cURus
	GVADU, GBADU				
Output chokes	TEP3720-0ES41	E333628	NMMS2	NMMS8	cURus
	TEP3820-OCS41				
	TEP4020-ORS41				
Motors	EZ or LM series synchronous servo motors	E488992	PRHZ2	PRHZ8	cURus
	Asynchronous motors	E216143	PRGY2	PRGY8	cURus
Encoder and power cables	All types	E172204 E170315 E356538	AVLV2	AVLV8	cURus
One Cable Solution Basic	All types	E356538	AVLV2	AVLV8	cURus
One Cable Solution Advanced	All types	E170315	AVLV2	AVLV8	cURus

Tab. 2: File number-certified products

2.5 Timeliness

Check whether this document is the latest version of the documentation. We make the latest document versions for our products available for download on our website:

<http://www.stoeber.de/en/downloads/>.

2.6 Original language

The original language of this documentation is German; all other language versions are derived from the original language.

2.7 Limitation of liability

This documentation was created taking into account the applicable standards and regulations as well as the current state of technology.

No warranty or liability claims for damage shall result from failure to comply with the documentation or from use that deviates from the intended use of the product. This is especially true for damage caused by individual technical modifications to the product or the project configuration and operation of the product by unqualified personnel.

2.8 Formatting conventions

Orientation guides in the form of signal words, symbols and special text markups are used to emphasize specific information so that you are able identify it in this documentation quickly.

2.8.1 Display of warning messages and information

Warning messages are identified with symbols. They indicate special risks when handling the product and are accompanied by relevant signal words that express the extent of the risk. Furthermore, useful tips and recommendations for efficient, error-free operation are specially highlighted.

ATTENTION!

Attention

This indicates that damage to property may occur

- if the stated precautionary measures are not taken.

⚠ CAUTION!

Caution

This word with a warning triangle indicates that minor personal injury may occur

- if the stated precautionary measures are not taken.

⚠ WARNING!

Warning

This word with a warning triangle means there may be a considerable risk of fatal injury

- if the stated precautionary measures are not taken.

⚠ DANGER!

Danger

This word with a warning triangle indicates that there is a considerable risk of fatal injury

- if the stated precautionary measures are not taken.

Information

Information indicates important information about the product or serves to emphasize a section in the documentation that deserves special attention from the reader.

Ⓛ WARNINGS!

Warnings

With the UL symbol, they mark text passages quoted from the original.

2.8.2 Markup of text elements

Certain elements of the continuous text are distinguished as follows.

Important information	Words or expressions with a special meaning
Interpolated position mode	Optional: File or product name or other name
<u>Detailed information</u>	Internal cross-reference
http://www.samplelink.com	External cross-reference

Software and other displays

The following formatting is used to identify the various information content of elements referenced by the software interface or a drive controller display, as well as any user entries.

Main menu Settings	Window names, dialog box names, page names or buttons, combined proper nouns, functions referenced by the interface
Select Referencing method A	Predefined entry
Save your <own IP address>	User-defined entry
EVENT 52: COMMUNICATION	Displays (status, messages, warnings, faults)

Keyboard shortcuts and command sequences or paths are represented as follows.

[Ctrl], [Ctrl] + [S]	Key, key combination
Table > Insert table	Navigation to menus/submenus (path specification)

2.8.3 Mathematics and formulas

The following signs are used to represent mathematical relationships and formulas.

–	Subtraction
+	Addition
×	Multiplication
÷	Division
	Absolute value

2.8.4 Conventions for cables

In the cable connection descriptions, core colors are shortened and used as follows.

Cable colors

BK:	BLACK	PK:	PINK
BN:	BROWN	RD:	RED
BU:	BLUE	VT:	VIOLET
GN:	GREEN	WH:	WHITE
GY:	GRAY	YE:	YELLOW
OG:	ORANGE		

Formatting conventions

Two-colored core:	WHYE	WHITEYELLOW (white-yellow core)
Single-colored core:	BK/BN	BLACK/BROWN (black or brown core)
Core pair:	BU-BK	BLUE-BLACK (blue and black core)

2.9 Marks and test symbols

The following marks and test symbols are mentioned in the technical data.



RoHS lead-free mark

Marking in accordance with RoHS directive 2011-65-EU.



CE mark

Manufacturer's self declaration: The product meets the requirements of EU directives.



UKCA test symbol

Manufacturer's self declaration: The product meets the requirements of UK directives.



UL test symbol (cULus)

This product is listed by UL for the United States and Canada.

Representative samples of this product have been evaluated by UL and meet the requirements of applicable standards.



UL recognized component mark (cURus)

This component or material is recognized by UL for the US and Canada.

Representative samples of this product have been evaluated by UL and meet applicable requirements.

2.10 Trademarks

The following names used in connection with the device, its optional equipment and its accessories are trademarks or registered trademarks of other companies:

CANopen [®] , CiA [®]	CANopen [®] and CiA [®] are registered trademarks of CAN in AUTOMATION e.V., Germany, the international user and manufacturer association.
CODESYS [®]	CODESYS [®] is a registered trademark of CODESYS GmbH, Germany.
EnDat [®]	EnDat [®] and the EnDat [®] logo are registered trademarks of Dr. Johannes Heidenhain GmbH, Germany.
EPLAN [®]	EPLAN [®] and the EPLAN [®] logo are registered trademarks of EPLAN Software & Service GmbH & Co. KG, Germany.
EtherCAT [®] , Safety over EtherCAT [®]	EtherCAT [®] and TwinCAT [®] are registered trademarks and patented technologies, licensed by Beckhoff Automation GmbH, Germany.
HIPERFACE [®]	HIPERFACE [®] and the HIPERFACE DSL [®] logo are registered trademarks of SICK AG, Germany.
Hyper-V [®]	Hyper-V [®] is a registered trademark of the Microsoft Corporation in the United States and/or other countries.
PLCopen [®]	PLCopen [®] is a registered trademark of the PLCopen Organisation, Netherlands.
PROFIBUS [®] , PROFINET [®]	PROFIBUS [®] and PROFINET [®] are registered trademarks of PROFIBUS Nutzerorganisation e.V., Germany.
PROFIdrive [®] , PROFIsafe [®]	PROFIdrive [®] and PROFIsafe [®] are registered trademarks of Siemens AG, Germany.
SIMATIC [®] , TIA Portal [®]	SIMATIC [®] and TIA Portal [®] are registered trademarks of Siemens AG, Germany.
speedtec [®]	speedtec [®] is a registered trademark of TE Connectivity Industrial GmbH, Germany.
TORX [®]	TORX [®] and the TORX [®] logo are registered trademarks of Acument Intellectual Properties in the USA and/or other countries.
TwinCAT [®]	TwinCAT [®] is a registered and licensed trademark of Beckhoff Automation GmbH, Germany.
VirtualBox [®]	VirtualBox [®] is a registered trademark of Oracle America, Inc., USA.
VMware [®]	VMware [®] is a registered trademark of VMware, Inc., USA.
Windows [®] , Windows [®] 7, Windows [®] 10, Windows [®] 11	Windows [®] , the Windows [®] logo, Windows [®] XP, Windows [®] 7, Windows [®] 10, and Windows [®] 11 are registered trademarks of Microsoft Corporation in the United States and/or other countries.

All other trademarks not listed here are the property of their respective owners.

Products that are registered as trademarks are not specially indicated in this documentation. Existing property rights (patents, trademarks, protection of utility models) are to be observed.

3 Safety notes

There are risks associated with the product described in this documentation that can be prevented by complying with the following basic safety notes as well as the included technical rules and regulations.

3.1 Qualified personnel

In order to be able to perform the tasks described in this documentation, the persons instructed to perform them must have the appropriate professional qualification and be able to assess the risks and residual hazards when handling the products. For this reason, all work on the products as well as their operation and disposal may be performed only by professionally qualified personnel.

Qualified personnel are persons who have acquired the authorization to perform these activities either through training to become a specialist and/or instruction by specialists.

Furthermore, valid regulations, legal requirements, applicable basic rules, this documentation and the safety notes included in it must be carefully read, understood and observed.

3.2 Intended use

As defined by EN 50178, drive controllers are electrical devices operating as power electronics to control the flow of energy in high-voltage systems.

The drive controllers are intended solely for the operation of motors that meet the requirements of EN 60034-1:

- Lean motors of the LM series
- Synchronous servo motors (e.g. of the EZ series)
- Asynchronous motors
- Linear motors
- Torque motors

The connection of other electronic loads or operation outside applicable technical specifications constitutes improper use.

When installing drive controllers in machines, commissioning (i.e. commencing intended operation) may not be performed until it has been determined that the machine is in compliance with local laws and directives.

EMC-compliant installation

The SC6 drive controller and accessories must be installed and wired compliant for EMC.

Modification

As the user, you may not make any physical, technical or electrical modifications to the SC6 drive controller and the accessories.

Maintenance

The SC6 drive controller and accessories are maintenance-free. However, take appropriate measures to detect or prevent possible errors in the connecting wiring.

3.3 Transport and storage

Inspect the delivery for any transport damage immediately after you receive it. Notify the transport company of any damage immediately. Do not put a damaged product into operation.

Store the products in a dry and dust-free room if you do not install them immediately.

Transport and store the products in the original packaging and protect the products from mechanical impacts and vibrations. Observe the transport and storage conditions recommended in the technical data.

Reform drive controllers in storage annually or before commissioning (see [Storage \[▶ 80\]](#)).

3.4 Operational environment and operation

The products are subject to sales restrictions in accordance with EN IEC 61800-3.

The products are not designed for use in a public low-voltage network that supplies residential areas. Radio-frequency interference can be expected if the products are used in this type of network.

The products are intended exclusively for installation in control cabinets with at least protection class IP54.

To ensure the faultless and safe operation of the products, they must be professionally configured, installed, operated and maintained.

Always operate the products within the limits specified by the technical data.

The following applications are prohibited:

- Use in potentially explosive atmospheres
- Use in environments with harmful substances as specified by EN 60721, such as oils, acids, gases, vapors, dust and radiation

Implementation of the following applications is permitted only after approval from STOBER:

- Use in non-stationary applications
- The connection of active and passive components (drive controllers, supply modules, regenerative feedback modules or discharge units) from third-party manufacturers

All device types are intended exclusively for operation on TN networks or wye sources that supply a maximum differential short-circuit current in accordance with the following table.

For UL-compliant operation:

All device types supplied with 480 V_{AC} are intended solely for operation with grounded wye sources at 480/277 V_{AC}.

For all device types – with 240 V_{AC} or 480 V_{AC} supply – the supply grid must not deliver a differential short-circuit current above the specification in the following table.

Size of the drive controller	Max. differential short-circuit current
Size 0 – size 2	5000 A

Tab. 3: Short-circuit current rating (SCCR)

The drive controller has a configurable restart. If the drive controller is designed for an automatic restart after energy shutdown, this must be clearly specified on the system in accordance with EN 61800-5-1.

The drive controller has the option of a Safe Torque Off safety function (STO) in accordance with EN 61800-5-2 for safely disconnecting the energy supply to the motor. Measures based on this for protection against unexpected startup are described in EN ISO 12100 and EN ISO 14118, for example.

3.5 Working on the machine

Before all work on machines and systems, apply the 5 safety rules in accordance with DIN VDE 0105-100 (Operation of electrical installations – Part 100: General requirements) in the order listed:

- Disconnect (also ensure that the auxiliary circuits are disconnected).
- Ensure power cannot be switched on again.
- Ensure that everything is de-energized.
- Ground and short-circuit.
- Cover adjacent live parts.

Information

Note the discharge time of the DC link capacitors in the general technical data for the devices. You can only determine the absence of voltage after this time period.

3.6 Installation

Installation work is permitted only when no voltage is present. Obey the 5 safety rules (see [Working on the machine \[▶ 19\]](#)).

WARNING!

Electrical voltage! Risk of fatal injury due to electric shock!

Hazardous voltages may be present on the connection terminals and the cores connected to them.

- Always switch off all power supply voltage before working on the devices!
- Note the discharge time of the DC link capacitors in the general technical data. You can only determine the absence of voltage after this time period.

Handle the devices with care:

- Do not damage any components or change any insulation distances when transporting or handling the devices.
- Avoid mechanical overloads.
- Do not touch any electronic components or contacts.

To protect the devices from overheating, obey the operating conditions described in the technical data and comply with the required minimum clearances for installation.

Protect the devices against falling parts (bits or strands of wire, pieces of metal, etc.) during installation or other work in the control cabinet. Parts with conductive properties may result in a short-circuit inside the devices and device failure as a result.

3.7 Electrical connection

Connection work is permitted only when no voltage is present. Observe the 5 safety rules (see [Working on the machine \[▶ 19\]](#)).

WARNING!

Electrical voltage! Risk of fatal injury due to electric shock!

Hazardous voltages may be present on the connection terminals and the cores connected to them.

- Always switch off all power supply voltage before working on the devices!
- Note the discharge time of the DC link capacitors in the general technical data. You can only determine the absence of voltage after this time period.

The device and the cables connected to it are not necessarily de-energized when the supply voltage is switched off and all displays have gone out!

Opening the housing, plugging in or unplugging connection terminals, connecting or removing a connecting wiring, and installing or removing accessories are prohibited while the voltage supply is switched on.

The device housing must be closed before you turn on the supply voltage.

If you couple drive controllers in the DC link, make sure that all Quick DC-Link modules are built over with a drive controller or covered with a Quick DC-Link cover after installation or after replacing a device.

Protect the devices against falling parts (bits or strands of wire, pieces of metal, etc.) during installation or other work in the control cabinet. Parts with conductive properties may result in a short-circuit inside the devices and device failure as a result.

Use only copper conductors. For the corresponding conductor cross-sections, consult the standards DIN VDE 0298-4 or EN 60204-1 (Annexes D, G) as well as the relevant terminal specifications in this documentation.

The protection class of the devices is protective grounding (protection class I in accordance with EN 61140). This means that operation is permitted only if the grounding conductor is connected according to requirements.

All protective ground connections are identified by "PE" or the international grounding symbol (IEC 60417, symbol 5019).

The products are not designed for use in a public low-voltage network that supplies residential areas. Radio-frequency interference can be expected if the products are used in this type of network.

3.8 Ensuring traceability

The orderer must ensure traceability of the products using the serial number.

3.9 Decommissioning

In safety-oriented applications, note the mission time $T_M = 20$ years in the safety-relevant key performance indicators. A drive controller with integrated safety module must be taken out of operation 20 years after the production date. The production date of the drive controller is found on the accompanying nameplate.

For detailed information about using the safety technology, refer to the corresponding manual (see [Detailed information \[▶ 402\]](#)).

3.10 Disposal

Observe the current national and regional regulations when disposing of the packaging and product! Dispose of the packaging and individual product parts depending on their properties, e.g. as:

- Cardboard
- Electronic waste (printed boards)
- Plastic
- Sheet metal
- Copper
- Aluminum
- Battery

3.11 Firefighting



Electrical voltage! Risk of fatal injury due to electric shock!

There is a risk of fatal injury due to electric shock when using conductive firefighting equipment.

- Use ABC powder or carbon dioxide (CO₂) for firefighting.

4 Security

Security refers to the protection and safety of your components and systems with regard to confidentiality, integrity and availability.

While functional safety technology focuses on the avoidance of systematic or random faults, security technology is based on targeted influences. These influences may be intentional or unintentional with direct or indirect access to equipment.

Security risks

- Incorrect operation, e.g. connection to an incorrect device
- Hardware:
 - Changing the wiring
 - Changing the device configuration, e.g. the FSoE address
 - Disassembly of accessories, e.g. the SD card
- Software:
 - Changing the firmware
 - Changing the device configuration, e.g. via DriveControlSuite, via the SD card or using script mode
 - Changing parameters
- Network structure

Recognizing and avoiding risks

For example, the following tools are available to help you identify risks and avoid tampering.

- Make sure that the device identification is unique:
 - Reference code
 - Communication address(es)
- After establishing the connection, make sure that communication with the desired device has been established.
- Test and log the (re)commissioning.
- Check the security log of the drive controller regularly (see [Security log](#) [▶ 400]).
- Limit access:
 - Physically (close off the control cabinet and electrical operating room)
 - Logically (restrict communication, e.g. by means of a firewall)
- Use sealing tape to detect tampering at the following interfaces:
 - Ethernet service interface X9
 - Fieldbus interfaces X200 and X201
 - SD slot X700
- Make sure that the controller runs a plausibility check:
 - Device status
 - Application-specific configuration ID

Planning measures

The requirements from the locally applicable safety and application standards regarding protection against tampering must be observed. The authorization of personnel and the implementation of the necessary protective measures are the responsibility of the operator.

All systems to be protected must be considered individually. Organizational protective measures are supported by technical measures. Technical measures alone are not sufficient.

In the course of planning, you should name and document the measures to be taken.

Such measures include:

- Sensible division of user groups
- Use of appropriate passwords
- Updated network plans

Network plans can be used to ensure that secure networks are permanently separated from public networks and, if necessary, that there is only defined access (e.g. via a firewall or a DMZ).

A regular, e.g. annual, review of the security measures is advisable.

Defense in depth concept

Counter risks with layered security solutions.

In accordance with EN IEC 62443-4-1, the defense-in-depth concept is an approach to defend the system against any kind of attack by applying multiple independent methods.

Features:

- The approach is based on the fundamental idea that any protective measure can be, and probably will be, overcome.
- Attackers have to overcome or bypass each layer without being detected.
- A weakness in one layer can be mitigated by the capabilities of another layer.
- The system's IT security becomes a set of layers within the overall IT network security.
- Each layer should stand alone, should not be based on the same functionality as the other layers and should not have the same failure modes as them.

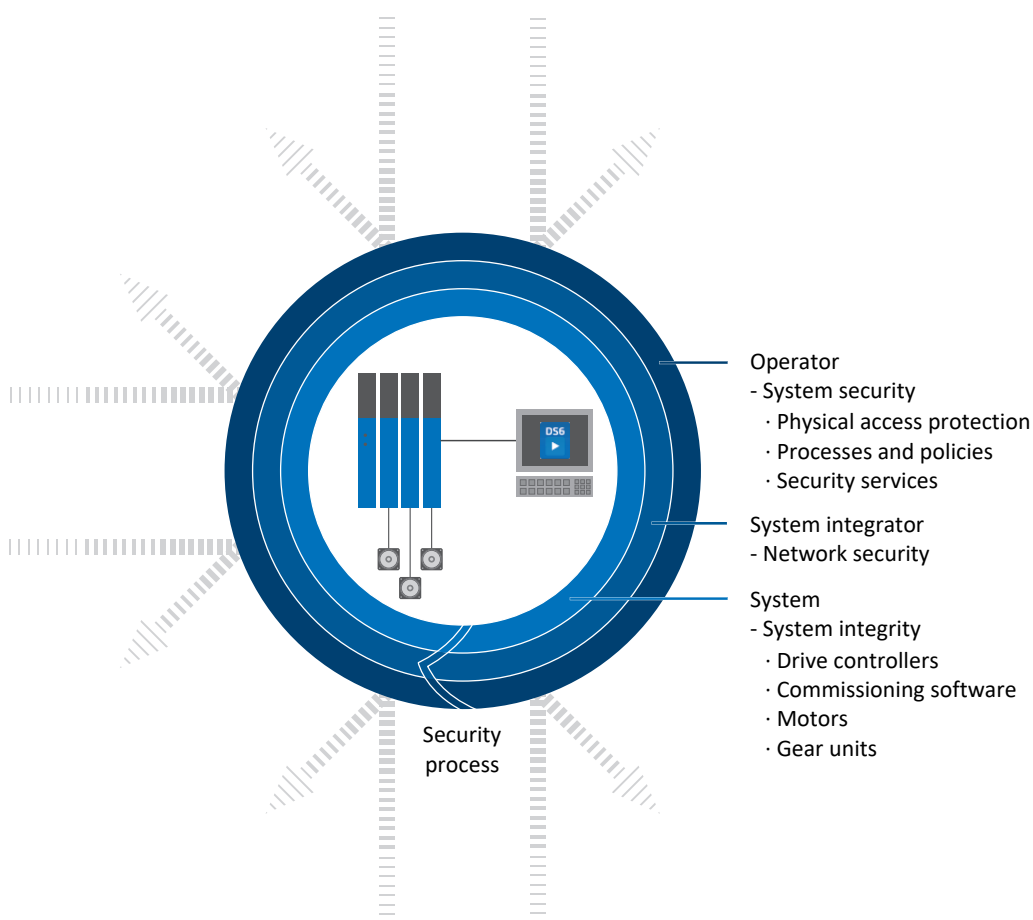

Fig. 1: Defense in depth concept

5 UL-compliant use

This chapter contains relevant information for use under UL conditions (UL – Underwriters Laboratories).

Surrounding air temperature and pollution degree

The maximum surrounding air temperature for UL-compliant operation is 45°C. Use in an environment up to pollution degree 2 is permitted.

Supply grid

All device types supplied with 480 V_{AC} are intended solely for operation with grounded wye sources at 480/277 V_{AC}.

For all device types – with 240 V_{AC} or 480 V_{AC} supply – the supply grid must not deliver a symmetrical short-circuit current above the specification in the following table.

Size of the drive controller	Max. differential short-circuit current
Size 0 – size 2	5000 A

Tab. 4: Short-circuit current rating (SCCR)

Line fuse

Obey the information on the [UL-compliant line fuse of the supplied drive controllers](#) [▶ 99].

Branch circuit protection

Integral solid state short-circuit protection does not provide branch circuit protection (line fuse) upstream of the drive controller. Branch circuit protection must be provided in accordance with the manufacturer instructions, the National Electrical Code, the Canadian Electrical Code, part I, and any additional local codes.

Protective grounding

The protective grounding of motors connected to the drive controller must not be connected using terminals X20A and X20B. The grounding conductor connection of the motor must be ensured for the respective application in accordance with the valid electrical standards.

The grounding at terminal X10 of the SC6 drive controller must not be used for protective grounding. The housing for the drive controllers must be connected to the protective grounding using the M6 ground bolt (4.0 Nm, 35 Lb.inch).

Original text:

WARNINGS!

Safety grounding

The external motors which are connected to the drive units SC6A shall not be grounded over the drive units. The bonding/grounding of the motor(s) shall occur in the end use application in accordance with the requirements of applicable electrical codes/standards.

The grounding provisions present on the terminals X20A/X20B of the SC6 unit are not intended for safety grounding of the motors. The grounding provision present on terminal X10 of the inverter unit is not to be used for the grounding of the drive system.

The chassis of each SC6A drive unit is to be bonded through the M6 grounding stud present on each SC6A unit.

The connection for the protective grounding on the housing is identified by the grounding symbol in accordance with IEC 60417 (symbol 5019).

For correct installation, obey the instructions for [UL-compliant connection of the grounding conductor](#) [▶ 103].

Functional grounding

In addition to the protective grounding, a functional grounding is required for proper operation of the SC6 drive controller and the motor. The functional grounding of the drive controller is connected using terminal X10, while that of the motor is connected using terminals X20A and X20B. The connections for the functional grounding to terminals X10, X20A and X20B are marked with PE. For UL-compliant operation: The connections marked with PE are intended solely for the functional grounding.

Motor overload protection/motor temperature protection

Use motor overload protection/motor temperature protection. The SC6 drive controller features connections for PTC thermistors (NAT 145 °C, sensor voltage = 3.3 V_{DC}, sensor current = max. 0.6 mA) at X2A/X2B, pins 7 and 8. The devices are only intended for use with motors with integrated temperature protection. In accordance with UL certification, operation without motor overload protection/motor temperature protection in or on the motor (X2 jumpers) is not permitted!

For a proper connection, follow the [terminal description for X2A/X2B \[▶ 107\]](#).

For EnDat 3 or HIPERFACE DSL encoders, the motor temperature is transmitted together with the encoder data over connector X4A/X4B. Additional cabling at terminal X2A/X2B is not needed.

Brake

Obey the [technical data for the brake \[▶ 64\]](#).

Digital inputs

For terminals X101 and X103, obey the [technical data for the digital inputs \[▶ 45\]](#).

Terminals

Note that the basic device is delivered without terminals. Suitable terminal sets are available separately for each size. An order overview of the available terminal sets can be found in the appendix.

The terminals are labeled accordingly for correct connection. Observe the connection overviews and terminal descriptions for the connection.

Power terminals

Use only copper conductors for a surrounding temperature of 60/75 °C.

24 V supply and fuses

Low-voltage circuits must be supplied by an isolated source with a maximum output voltage that does not exceed 30 V_{DC}.

Fuses for 24 V_{DC} supplies must be approved for DC voltage in accordance with UL 248.

- Protect the 24 V_{DC} supply of the control unit with a 10 A fuse (time delay). Follow the [terminal description for X11 \[▶ 118\]](#), pin 1 or 2 (+).
- Protect the 24 V_{DC} supply for the brake with a 10 A fuse (time delay). Follow the [terminal description for X300 \[▶ 129\]](#), pin 1 or 2 (+).
- The following applies to the STO safety function via terminal X12 (option SR6): Protect the supply voltage of the status signal with a 3.15 A fuse (time delay). Follow the [terminal description for X12 \[▶ 119\]](#), pin 8 (U_{1status}).

UL test

Only the risks of electric shock and the risk of fire have been examined during UL acceptance. Functional safety aspects have not been assessed during the UL approval process. These are assessed for STOBER by bodies such as the TÜV SÜD certification service.

6 System design

For connecting to a controller, we recommend the PROFINET fieldbus in combination with the Drive Based or PROFIdrive application. As an alternative, you can use the EtherCAT fieldbus and an application with a CiA 402 interface. You commission the drive controller using the DriveControlSuite software.

The drive controllers offer the STO safety function in accordance with EN 61800-5-2 as an option. For connection to a higher-level safety circuit, different interfaces are available.

The following graphic explains the principle system design.

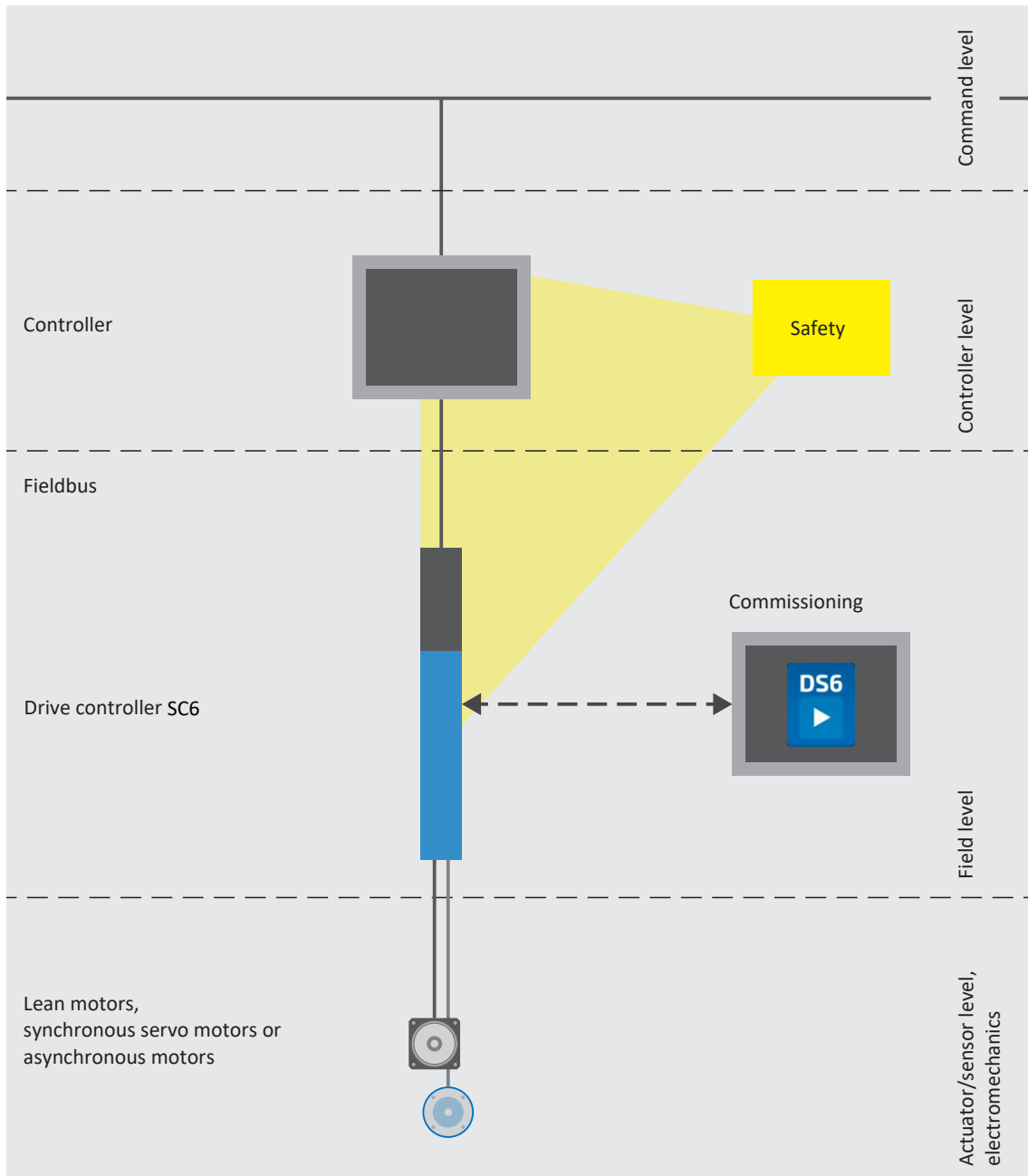

Fig. 2: System overview

6.1 Hardware components

Below you will find an overview of the available hardware components.

6.1.1 Drive controllers

The SC6 drive controller is available in several sizes as a single or double-axis controller. Various safety options are also available.

6.1.1.1 Nameplate

The nameplate is placed on the side of the drive controller.

STOBER
 Kieselbronner Str. 12 | 75177 Pforzheim | Germany
 Phone: + 49 7231 582-0 | www.stober.com

Type	ID no.	HW	Date	S/N
SC6A062	56690	040 HD 2311		9000002

Eingangsspannung Input voltage Tension d'entrée: 3 x 400 V_{AC} 50 Hz
 UL: 3 x 480 V_{AC} 50-60 Hz

Eingangsstrom Input current Current d'entrée: UL: 7.0 A

Ausgangsdaten Output data Données de sortie: 0..460 V_{AC}
 0..700 Hz
 @4 kHz: 2 x 4.5 A
 @8 kHz: 2 x 4.0 A
 3-phase

Schutzart Protection class: IP20
 Efficiency: IE2
 η_N = 96,3%

WARNING: GEFAHR DES ELEKTRISCHEN SCHLAGS. GEFAHRLICHE SPANNUNGEN KÖNNEN NACH DEM ABSCHALTEN FÜR 15 MINUTEN ANLIEGEN.
 Inbetriebnahmeanleitung beachten!

WARNING: RISK OF ELECTRIC SHOCK. DANGEROUS VOLTAGE MAY EXIST FOR 15 MINUTES AFTER REMOVING POWER.
 Always observe the commissioning instructions!

AVERTISSEMENT: RISQUE DU CHOC ÉLECTRIQUE. UNE TENSION DANGEREUSE PEUT ÊTRE PRÉSENTÉE JUSQU' À 15 MINUTES APRÈS AVOIR COUPÉ L' ALIMENTATION.
 Veuillez respecter la notice de mise en service!

For UL/cUL: Power Terminals: Use 60/75 °C Copper Conductors Only

Fig. 3: SC6A062 nameplate

Designation	Value in example	Meaning
Type	SC6A062	Production information
ID No.	56690	
HW	040 HD	
Date	2311 (year/calendar week)	
S/N	9000002	
Input voltage	3 × 400 V _{AC} 50 Hz UL: 3 × 480 V _{AC} 50 – 60 Hz	Input voltage
Input current	UL: 7.0 A	Input current
Output data	0 to 460 V _{AC}	Output voltage
	0 to 700 Hz	Output frequency
	@4 kHz: 2 × 4.5 A	Output current for 4 kHz clock frequency
Protection class	IP20	Protection class
Efficiency	IE2	Energy efficiency class
	$\eta_N = 96.3\%$	Nominal efficiency

Tab. 5: Meaning of the specifications on the nameplate

Information

UL and cUL-certified devices with corresponding test symbols meet the requirements of the standards UL 61800-5-1 and CSA C22.2 No. 274.

6.1.1.2 Type designation

SC	6	A	0	6	2	Z
----	---	---	---	---	---	---

Tab. 6: Example code for type designation

Code	Designation	Design
SC	Series	
6	Generation	Generation 6
A	Version	
0 – 2	Size	
6	Power output stage	Power output stage within the size
2 1	Axis controller	Double-axis controller Single-axis controller
Z R U Y X	Safety technology	SZ6: Without safety technology SR6: STO using terminals SU6: STO and SS1 using PROFIsafe SY6: STO and SS1 using FSoE SX6: Extended safety technology using FSoE

Tab. 7: Meaning of the example code

6.1.1.3 Material variant

On the side of the drive controller above the nameplate, there is another sticker with the material variant (MV) and serial number (SN).



Fig. 4: Sticker with MV and serial number

Designation	Value in example	Meaning
MV	MV0000012345	MV number
SN	6001192064	Serial number
—	SC6A062Z	Device type according to type designation
—	1000914812/001100	Order number/order item

Tab. 8: Meaning of the specifications on the sticker

6.1.1.4 Sizes

Type	ID No.	Size	Axis controller
SC6A062	56690	Size 0	Double-axis controller
SC6A162	56691	Size 1	Double-axis controller
SC6A261	56692	Size 2	Single-axis controller

Tab. 9: Available SC6 types and sizes



SC6 in sizes 0 to 2

Note that the basic device is delivered without terminals. Suitable terminal sets are available separately for each size.

Terminal set for drive controllers without SR6 safety module (STO using terminals)

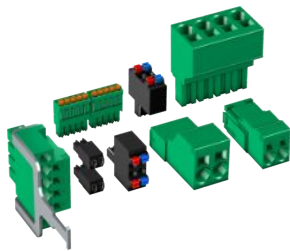

(Fig. similar)

The following designs are available:

ID No. 138652

Terminal set for SC6A062Z/U/Y. Contents: 13 terminals.

ID No. 138653

Terminal set for SC6A162Z/U/Y. Contents: 13 terminals.

ID No. 138654

Terminal set for SC6A261Z/U/Y. Contents: 10 terminals.

Terminal set for drive controllers with SR6 safety module (STO using terminals)

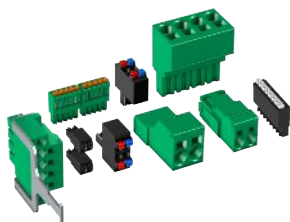

(Fig. similar)

The following designs are available:

ID No. 138680

Terminal set for SC6A062R. Contents: 14 terminals.

ID No. 138681

Terminal set for SC6A162R. Contents: 14 terminals.

ID No. 138682

Terminal set for SC6A261R. Contents: 11 terminals.

6.1.2 Operating motors, encoders and brakes

You can use the SC6 drive controller to operate Lean motors of the LM series, synchronous servo motors (such as those of the EZ series), asynchronous motors, linear motors or torque motors.

Evaluation options for feedback are available on the X4 connection for the following encoders:

- EnDat 2.1/2.2 digital encoders
- SSI encoders
- Differential TTL and differential HTL incremental encoders (HTL via HT6 adapter)
- Resolver
- EnDat 3 or HIPERFACE DSL encoder (with One Cable Solution design)

In addition, evaluation options for the following encoders are available on the X101 and X103 connection:

- Single-ended HTL incremental encoders
- Single-ended HTL pulse/direction interface

All device types of the SC6 drive controller have connections for PTC thermistors and can control a 24 V_{DC} brake as standard.

6.1.3 Accessories

You can find information about the available accessories in the following chapters.

6.1.3.1 Safety technology

The safety modules are used to realize the STO safety function. They prevent the generation of a rotating magnetic field in the power unit of the drive controller. For an external requirement or in the event of error, the safety module switches the drive controller to the STO state. Different human-machine interfaces and additional safety functions are available depending on the selected design of the accessories.

For double-axis controllers, the STO safety function has a two-channel structure that acts upon both axes.

Information

The drive controller is delivered in the standard design without safety technology (option SZ6). If you want a drive controller with integrated safety technology, you must order it together with the drive controller. The safety modules are an integrated part of the drive controllers and must not be modified.

SZ6 option – Without safety technology

ID No. 56660

Design without safety technology.

SX6 safety module – Extended safety technology using FSoE

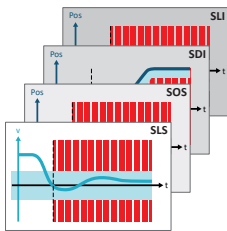

ID No. 5050185

Optional accessory for use in safety-related applications up to PL e, SIL 3 in accordance with EN ISO 13849-1 and EN 61800-5-2. In addition to the basic Safe Torque Off (STO) safety function, SX6 provides other safety functions specified in EN 61800-5-2. In addition to the Safe Stop 1 (SS1) and Safe Stop 2 (SS2) safe stop functions, they include Safely-Limited Speed (SLS), Safe Brake Control (SBC), Safe Direction (SDI) and Safely-Limited Increment (SLI). Connection to the higher-level safety circuit using Fail Safe over EtherCAT (FSoE).

SR6 safety module – STO using terminals



ID No. 56661

Optional accessory for the use of the Safe Torque Off safety function (STO) in safety-relevant applications (PL e, SIL 3) in accordance with EN ISO 13849-1 and EN 61800-5-2. Connection to a higher-level safety circuit via terminal X12.

SY6 safety module – STO and SS1 using FSoE



ID No. 56662

Optional accessory for the use of the Safe Torque Off (STO) and Safe Stop 1 (SS1) safety functions in safety-relevant applications (PL e, SIL 3) in accordance with EN ISO 13849-1 and EN 61800-5-2. Connection to the higher-level safety circuit using Fail Safe over EtherCAT (FSoE).

SU6 safety module – STO and SS1 using PROFIsafe



ID No. 56696

Optional accessory for the use of the Safe Torque Off (STO) and Safe Stop 1 (SS1) safety functions in safety-relevant applications (PL e, SIL 3) in accordance with EN ISO 13849-1 and EN 61800-5-2. Connection to a higher-level safety circuit via PROFINET (PROFIsafe).

For detailed information about using the safety technology, refer to the corresponding manual (see [Detailed information \[▶ 402\]](#)).

6.1.3.2 Communication

The drive controller has two interfaces for the EtherCAT or PROFINET connection on the top of the device as well as an Ethernet service interface on the front of the device. Cables for the connection are available separately.

EtherCAT or PROFINET



Specify the desired fieldbus system when placing your order for the base device, since fieldbus communication is defined by the firmware.



EtherCAT cables



Ethernet patch cable, CAT5e, yellow.

The following designs are available:

ID No. 49313: Length approx. 0.25 m.

ID No. 49314: Length approx. 0.5 m.

PC connecting cable



ID No. 49857

Cable for connecting the X9 service interface to the PC, CAT5e, blue, length: 5 m.

USB 2.0 Ethernet adapter



ID No. 49940

Adapter for connecting Ethernet to a USB port.

For detailed information about the fieldbus connection, refer to the corresponding manual (see [Detailed information \[▶ 402\]](#)).

6.1.3.3 DC link connection

If you want to connect SC6 drive controllers in the DC link group, you will need Quick DC-Link modules of type DL6B.

You receive the DL6B rear section modules in different designs for a horizontal connection, suitable for the size of the drive controller.

The quick fastening clamps for attaching the copper rails and an insulation connection piece are contained in the scope of delivery. The copper rails are not included in the scope of delivery. These must have a cross-section of 5 x 12 mm. Insulation end sections for the left and right termination of the device group as well as covers for the rear section modules are available separately. The covers protect rear section modules installed in the control cabinet that are only later built over with drive controllers, for example as part of a retrofit.

Quick DC-Link DL6B – rear section module for drive controller



The following designs are available:

DL6B10

ID No. 56655

Rear section module for size 0 drive controller:

SC6A062

DL6B11

ID No. 56656

Rear section module for size 1 or 2 drive controller:

SC6A162 and SC6A261

Quick DC-Link DL6B – insulation end section



ID No. 56659

Insulation end sections for the left and right termination of the group, 2 pcs.

Quick DC-Link DL6B – cover



The following designs are available:

QDL6C10

Id. No. 5050128

Cover for rear section module DL6B10,

Dimensions: 373 × 45 × 1 mm

QDL6C11

Id. No. 5050129

Cover for rear section module DL6B11,

Dimensions: 373 × 64 × 1 mm

6.1.3.4 Braking resistor

STOBER offers braking resistors in different sizes and performance classes.

For more detailed information on this, refer to the technical data (see [Braking resistor](#) [▶ 65]).

6.1.3.5 Choke

STOBER offers various chokes corresponding to your application.

For more detailed information, refer to the technical data (see [Choke](#) [▶ 69]).

6.1.3.6 Encoder battery module

Absolute Encoder Support AES

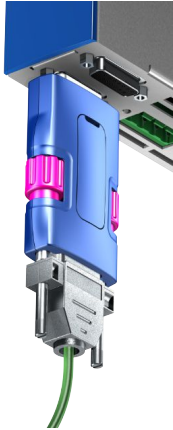

ID No. 55452

Battery module for buffering the supply voltage when using the EnDat 2.2 digital inductive encoder with battery-buffered multi-turn stage, for example EBI 1135 or EBI 135.

A battery is included.

Information

Note that a 15-pin extension cable between the socket and the AES may be necessary for the connection to the drive controller due to limited space.

A commercially available shielded extension cable with a 15-pin D-sub connector and a length of ≤ 1 m can be used between the socket and the AES.

AES replacement battery



ID No. 55453

Replacement battery for AES battery module.

6.1.3.7 HTL-to-TTL adapter

HT6 HTL-to-TTL adapter



ID No. 56665

Adapters for SC6 and SI6 series drive controllers for level conversion from HTL signals to TTL signals.

It is used to connect an HTL differential incremental encoder to terminal X4 of the drive controller.

6.1.3.8 Interface adapters

AP6 interface adapters



The following variants are available:

AP6A00

ID No. 56498

Adapter X4 resolver, 9/15-pin.

Adapter for connecting resolver cables with a 9-pin D-sub connector to the X4 encoder interface of the drive controller.

AP6A01

ID No. 56522

Adapter X4 resolver, 9/15-pin with cores of the motor temperature sensor led out at the side (core length: approx. 11 cm).

Adapter for connecting resolver cables with a 9-pin D-sub connector to the X4 encoder interface of the drive controller.

6.2 Software components

Various software components are available for commissioning your drive system and implementing your application.

6.2.1 Project configuration and parameterization

For project configuration and parameterization, the drive controller can be addressed using the DriveControlSuite commissioning software (DS6). The program guides you step by step through the complete project configuration and parameterization process using wizards.

6.2.2 Applications

A drive-based application is recommended for the decentralized motion control of sophisticated machines.

The drive-based application package from STOBER is the right choice wherever universal and flexible solutions are needed. The Drive Based application provides drive-based motion control for positioning, velocity and torque/force with the PLCopen Motion Control command set. These standard commands have been combined into operating modes for different applications and supplemented with additional functions such as motion block linking, cams and much more. For the command operating mode, all properties of the movements are specified directly by the controller. The properties of the movements in the drive are predefined in the motion block operating mode so that only a start signal is necessary to perform the movement. Linking can be used to define complete motion sequences. There is a separate operating mode available for applications controlled by velocity or torque/force such as pumps, fans or conveyor belts. This also allows for operation without a controller.

In addition, the CiA 402 and PROFIdrive applications are also available, which include both the controller-based and drive-based operating modes and application classes. For example, standard telegrams 1, 2 and 3 as well as telegrams 102 and 111 are available for standard drives according to PROFIdrive in application class 1 and for decentralized positioning control according to application class 3. Based on these telegrams, the drive controllers can be used with the SpeedAxis and BasicPos (EPos) technology objects.

Furthermore, programming based on IEC 61131-3 with CFC can be used to create new applications or expand existing ones.

For detailed information about the available applications, refer to the corresponding manual (see [Detailed information \[▶ 402\]](#)).

7 Technical data

Technical data for the drive controllers and accessories can be found in the following chapters.

7.1 Drive controllers

The following chapters contain specifications for the electrical data, dimensions and weight of the drive controller.

7.1.1 General technical data

The following information applies to all device types.

Device features	
Protection class of the device	IP20
Protection class of the installation space	At least IP54
Protection class	Protection class I in accordance with EN 61140
Radio interference suppression	Integrated line filter in accordance with EN 61800-3, interference emission class C3
Overvoltage category	III in accordance with EN 61800-5-1
Marks and test symbols	CE, cULus, RoHS

Tab. 10: Device features

Transport and storage conditions	
Storage/ transport temperature	-20 °C to +70 °C Maximum change: 20 K/h
Relative humidity	Maximum relative humidity 85%, non-condensing
Vibration (transport) in accordance with EN 60068-2-6	5 Hz ≤ f ≤ 9 Hz: 3.5 mm 9 Hz ≤ f ≤ 200 Hz: 10 m/s ² 200 Hz ≤ f ≤ 500 Hz: 15 m/s ²
Fall height for free fall ¹ Weight < 100 kg in accordance with EN 61800-2 (or IEC 60721-3-2, class 2M4)	0.25 m
Shock testing in accordance with EN 60068-2-27	Pulse shape: Half-sine Acceleration: 5 g Shock duration: 30 ms Number of shocks: 3 per axis

Tab. 11: Transport and storage conditions

¹ Only valid for components in their original packaging.

Operating conditions	
Surrounding temperature during operation	0 °C to 45 °C with nominal data 45 °C to 55 °C with derating –2.5% / K
Relative humidity	Maximum relative humidity 85%, non-condensing
Installation altitude	0 m to 1000 m above sea level without restrictions 1000 m to 2000 m above sea level with –1.5%/100 m derating
Pollution degree	Pollution degree 2 in accordance with EN 50178
Ventilation	Installed fan
Vibration (operation) in accordance with EN 60068-2-6	5 Hz ≤ f ≤ 9 Hz: 0.35 mm 9 Hz ≤ f ≤ 200 Hz: 1 m/s ²

Tab. 12: Operating conditions

Discharge times	
Self-discharge of DC link	15 min

Tab. 13: Discharge times of the DC link circuit

7.1.2 Electrical data

The electrical data of the available sizes as well as the properties of the brake chopper can be found in the following chapters.

Information

For the time span between two energizing processes, note that:

- Direct, repeat activation of the supply voltage is possible for cyclical power-on/power-off operation.
- A time span of > 15 minutes must be observed between two energizing processes during cyclical power-on/power-off operation with increased charging capacity.

Information

The STO safety function is available for safe stopping as an alternative to continuous, cyclical power-on/power-off operation.

For an explanation of the formula symbols used, see [Symbols in formulas \[▶ 404\]](#).

7.1.2.1 Control unit

Electrical data	All types
U_{1CU}	24 V _{DC} , +20%/–15%
I_{1maxCU}	1.5 A

Tab. 14: Control unit electrical data

7.1.2.2 Power unit: Size 0

Electrical data	SC6A062
U_{1PU}	$3 \times 400 V_{AC}$, +32% / -50%, 50/60 Hz; $3 \times 480 V_{AC}$, +10% / -58%, 50/60 Hz
f_{2PU}	0 – 700 Hz
U_{2PU}	0 – max. U_{1PU}
$U_{2PU,ZK}$	$\sqrt{2} \times U_{1PU}$
C_{PU}	270 μ F
$C_{N,PU}$	1400 μ F
C_{maxPU}	1880 μ F

Tab. 15: SC6 electrical data, size 0

The charging capacity depends on the time between two energizing processes:

Information

For the maximum charging capacity C_{maxPU} , a time span of ≥ 15 min must be maintained between two energizing processes.

Nominal currents up to +45 °C (in the control cabinet)

Electrical data	SC6A062
$f_{PWM,PU}$	4 kHz
$I_{1N,PU}$	10 A
$I_{2N,PU}$	2×4.5 A
I_{2maxPU}	210% for 2 s; 150% for 30 s

Tab. 16: SC6 electrical data, size 0, for 4 kHz clock frequency

Electrical data	SC6A062
$f_{PWM,PU}$	8 kHz
$I_{1N,PU}$	8.9 A
$I_{2N,PU}$	2×4 A
I_{2maxPU}	250% for 2 s; 200% for 5 s

Tab. 17: SC6 electrical data, size 0, for 8 kHz clock frequency

Electrical data	SC6A062
U_{onCH}	780 – 800 V_{DC}
U_{offCH}	740 – 760 V_{DC}
R_{2minRB}	100 Ω
P_{maxRB}	6.4 kW
P_{effRB}	2.9 kW

Tab. 18: Brake chopper electrical data, size 0

7.1.2.3 Power unit: Size 1

Electrical data	SC6A162
U_{1PU}	$3 \times 400 V_{AC}$, +32% / -50%, 50/60 Hz; $3 \times 480 V_{AC}$, +10% / -58%, 50/60 Hz
f_{2PU}	0 – 700 Hz
U_{2PU}	0 – max. U_{1PU}
$U_{2PU,ZK}$	$\sqrt{2} \times U_{1PU}$
C_{PU}	940 μF
$C_{N,PU}$	1400 μF
C_{maxPU}	1880 μF

Tab. 19: SC6 electrical data, size 1

The charging capacity depends on the time between two energizing processes:

Information

For the maximum charging capacity C_{maxPU} , a time span of ≥ 15 min must be maintained between two energizing processes.

Nominal currents up to +45 °C (in the control cabinet)

Electrical data	SC6A162
$f_{PWM,PU}$	4 kHz
$I_{1N,PU}$	23.2 A
$I_{2N,PU}$	2×10 A
I_{2maxPU}	210% for 2 s; 150% for 30 s

Tab. 20: SC6 electrical data, size 1, for 4 kHz clock frequency

Electrical data	SC6A162
$f_{PWM,PU}$	8 kHz
$I_{1N,PU}$	20.9 A
$I_{2N,PU}$	2×9 A
I_{2maxPU}	250% for 2 s; 200% for 5 s

Tab. 21: SC6 electrical data, size 1, for 8 kHz clock frequency

Electrical data	SC6A162
U_{onCH}	780 – 800 V_{DC}
U_{offCH}	740 – 760 V_{DC}
R_{2minRB}	47 Ω
P_{maxRB}	13.6 kW
P_{effRB}	6.2 kW

Tab. 22: Brake chopper electrical data, size 1

7.1.2.4 Power unit: Size 2

Electrical data	SC6A261
U_{1PU}	$3 \times 400 V_{AC}$, +32% / -50%, 50/60 Hz; $3 \times 480 V_{AC}$, +10% / -58%, 50/60 Hz
f_{2PU}	0 – 700 Hz
U_{2PU}	0 – max. U_{1PU}
$U_{2PU,ZK}$	$\sqrt{2} \times U_{1PU}$
C_{PU}	940 μ F
$C_{N,PU}$	1400 μ F
C_{maxPU}	1880 μ F

Tab. 23: SC6 electrical data, size 2

The charging capacity depends on the time between two energizing processes:

Information

For the maximum charging capacity C_{maxPU} , a time span of ≥ 15 min must be maintained between two energizing processes.

Nominal currents up to +45 °C (in the control cabinet)

Electrical data	SC6A261
$f_{PWM,PU}$	4 kHz
$I_{1N,PU}$	22.6 A
$I_{2N,PU}$	19 A
I_{2maxPU}	210% for 2 s; 150% for 30 s

Tab. 24: SC6 electrical data, size 2, for 4 kHz clock frequency

Electrical data	SC6A261
$f_{PWM,PU}$	8 kHz
$I_{1N,PU}$	17.9 A
$I_{2N,PU}$	15 A
I_{2maxPU}	250% for 2 s; 200% for 5 s

Tab. 25: SC6 electrical data, size 2, for 8 kHz clock frequency

Electrical data	SC6A261
U_{onCH}	780 – 800 V_{DC}
U_{offCH}	740 – 760 V_{DC}
R_{2minRB}	47 Ω
P_{maxRB}	13.6 kW
P_{effRB}	6.2 kW

Tab. 26: Brake chopper electrical data, size 2

7.1.2.5 X101, X103: Digital inputs

Feature	Value
Internal device update rate	Cycle time for the application parameterized in A150; $t_{\min} = 250 \mu\text{s}$; also applicable to digital inputs DI3 and DI4 as well as DI8 and DI9: with timestamp correction in an accuracy range of $1 \mu\text{s}$
Max. cable length	30 m

Tab. 27: Technical data – Inputs and outputs

X101 – Digital inputs

The inputs are suitable for the connection of PELV voltage in accordance with EN 60204-1.

Electrical data	Digital input	Value
Low level	DI1 – DI4	$0 - 8 V_{\text{DC}}$
High level		$12 - 30 V_{\text{DC}}$
$U_{1\text{max}}$		$30 V_{\text{DC}}$
$I_{1\text{max}}$		16 mA
$f_{1\text{max}}$	DI1 – DI2	10 kHz
	DI3 – DI4	250 kHz

Tab. 28: X101 electrical data – Digital inputs

X103 – Digital inputs

The inputs are suitable for the connection of PELV voltage in accordance with EN 60204-1.

Electrical data	Digital input	Value
Low level	DI6 – DI9	$0 - 8 V_{\text{DC}}$
High level		$12 - 30 V_{\text{DC}}$
$U_{1\text{max}}$		$30 V_{\text{DC}}$
$I_{1\text{max}}$		16 mA
$f_{1\text{max}}$	DI6 – DI7	10 kHz
	DI8 – DI9	250 kHz

Tab. 29: X103 electrical data – Digital inputs

7.1.2.6 Single-ended nominal power consumption on double-axis controllers

Operating two motors on one double-axis controller makes it possible to operate one of the motors with a continuous current above the nominal current of the drive controller if the continuous current of the second connected motor is lower than the nominal current of the drive controller. This enables economical combinations of double-axis controllers and motors.

For an explanation of the formula symbols used, see [Symbols in formulas \[▶ 404\]](#).

The nominal output current for axis B can be determined using the following formula if the output current for axis A is known:

Formula 1

$$I_{2PU(B)} = I_{2N,PU} - (I_{2PU(A)} - I_{2N,PU}) \times \frac{3}{5} \quad \text{for} \quad 0 \leq I_{2PU(A)} \leq I_{2N,PU}$$

Formula 2

$$I_{2PU(B)} = I_{2N,PU} - (I_{2PU(A)} - I_{2N,PU}) \times \frac{5}{3} \quad \text{for} \quad I_{2N,PU} \leq I_{2PU(A)} \leq 1,6 \times I_{2N,PU}$$

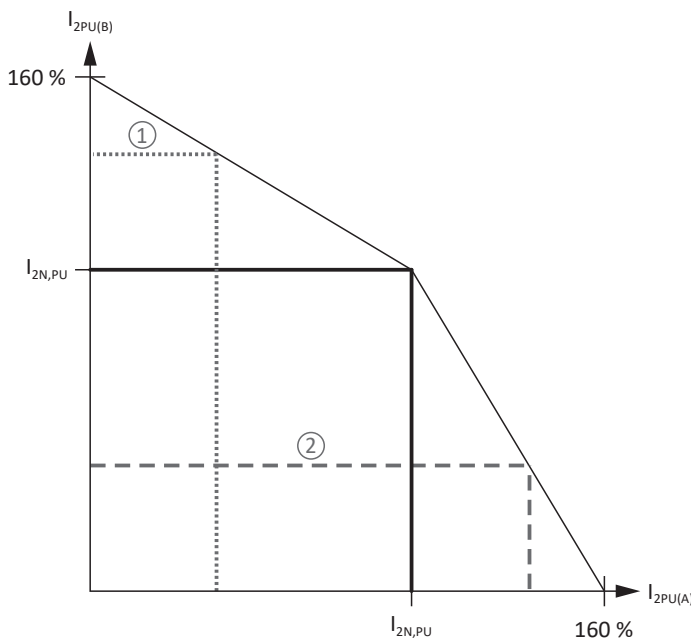

Fig. 5: Asymmetric load on double-axis controllers

Information

Note that the available maximum currents I_{2maxPU} of the axis controllers are also relative to the nominal output current $I_{2N,PU}$ for single-ended nominal power consumption.

Sample calculation

An EZ402U synchronous servo motor is to be operated on axis A and an EZ302U synchronous servo motor on axis B of a SC6A062 drive controller at a clock frequency of 8 kHz.

You need the following values for the calculation:

- Nominal output current $I_{2N,PU}$ of the drive controller
- Nominal currents I_N of both motors

The values for the devices mentioned are:

- $I_{2N,PU}$ (SC6A062) = 2×4.0 A
- I_N (EZ402U) = 4.4 A
- I_N (EZ302U) = 1.6 A

To check whether axis B of the drive controller provides enough current for motor B when motor A requires 4.4 A for operation, use formula 2. Formula 2 is used because the nominal output current of the drive controller is less than the output current of the power unit for axis A ($I_{2PU(A)}$). The output current of the power unit for axis B is calculated as follows:

$$I_{2PU(B)} = 4.0 \text{ A} - (4.4 \text{ A} - 4.0 \text{ A}) \times 5 \div 3 = 3.33 \text{ A}$$

Result: Axis B supplies sufficient current for motor B (3.33 A > 1.6 A).

7.1.2.7 Power loss data in accordance with EN 61800-9-2

Type	Nominal current $I_{2N,PU}$	Apparent power	Absolute losses $P_{V,CU}^2$	Operating points ³								IE class ⁴	Comparison ⁵
				(0/25)	(0/50)	(0/100)	(50/25)	(50/50)	(50/100)	(90/50)	(90/100)		
				Relative losses									
	[A]	[kVA]	[W]	[%]									
SC6A062	4.5	6.2	Max. 10	1.34	1.49	1.86	1.40	1.63	2.19	1.84	2.77	IE2	
SC6A162	10	13.9	Max. 10	0.76	0.92	1.43	0.81	1.04	1.75	1.22	2.29	IE2	
SC6A261	19	13.2	10	0.77	0.95	1.56	0.82	1.08	1.89	1.25	2.43	IE2	
				Absolute losses									
	[A]	[kVA]	[W]	[W]									[%]
SC6A062	4.5	6.2	Max. 10	83.2	92.5	115.2	86.7	100.8	135.8	113.9	171.7	IE2	36.0
SC6A162	10	13.9	Max. 10	105.5	128.3	198.8	113.1	145.1	243.5	170.1	318.7	IE2	40.8
SC6A261	19	13.2	Max. 10	101.2	125.8	206.1	108.5	142.0	249.5	165.6	320.4	IE2	41.0

Tab. 30: Power loss data of the SC6 drive controller in accordance with EN 61800-9-2

General conditions

The specified losses apply to a drive controller. They apply to both axes together in the case of double-axis controllers.

The power loss data applies to drive controllers without accessories.

The power loss calculation is based on a 3-phase supply voltage with 400 V_{AC}/50 Hz.

The calculated data includes a supplement of 10% in accordance with EN 61800-9-2.

The power loss specifications refer to a clock frequency of 4 kHz.

The absolute losses for a power unit that is switched off refer to the 24 V_{DC} power supply of the control electronics.

² Absolute losses for a power unit that is switched off

³ Operating points for relative motor stator frequency in % and relative torque current in %

⁴ IE class in accordance with EN 61800-9-2

⁵ Comparison of the losses for the reference related to IE2 in the nominal point (90, 100)

7.1.2.8 Power loss data of accessories

If you intend to order the drive controller with accessory parts, losses increase as follows.

Type	Absolute losses P_v [W]
SR6 safety module	1
SY6 or SU6 safety module	2
SX6 safety module	< 4

Tab. 31: Absolute losses of the accessories

Information

Note the absolute power loss of the encoder (usually < 3 W) and of the brake when designing as well.

Loss specifications for other optional accessories can be found in the technical data of the respective accessory part.

7.1.3 Cycle times

Possible cycle times can be found in the following table.

Type	Cycle times	Relevant parameters
Application	250 μ s, 500 μ s, 1 ms, 2 ms, 4 ms, 8 ms	Adjustable in A150
EtherCAT fieldbus, cyclical communication	250 μ s, 500 μ s, 1 ms, 2 ms, 4 ms, 8 ms	Adjustable in TwinCAT 3 or CODESYS
PROFINET RT fieldbus, cyclical communication	1 ms, 2 ms, 4 ms, 8 ms	Adjustable in the TIA Portal
PROFINET IRT fieldbus, cyclical communication	1 ms, 2 ms, 4 ms	Adjustable in the TIA Portal
Motion core (movement calculation)	250 μ s	—
Control cascade	62.5 μ s	B24 \geq 8 kHz and B20 = 48, 64 or 70
	125 μ s	B24 = 4 kHz

Tab. 32: Cycle times

Information

For Lean motors (control mode B20 = 32: LM - sensorless vector control), only operation at 4 kHz is permitted.

7.1.4 Derating

When dimensioning the drive controller, observe the derating of the nominal output current as a function of the clock frequency, surrounding temperature and installation altitude. There is no restriction for a surrounding temperature from 0 °C to 45 °C and an installation altitude of 0 m to 1000 m. The details given below apply to values outside these ranges.

7.1.4.1 Effect of the clock frequency

Changing the clock frequency f_{PWM} affects the amount of noise produced by the drive, among other things. However, increasing the clock frequency results in increased losses. During project configuration, define the highest clock frequency and use it to determine the nominal output current $I_{2N,PU}$ for dimensioning the drive controller.

Type	$I_{2N,PU}$ 4 kHz [A]	$I_{2N,PU}$ 8 kHz [A]	$I_{2N,PU}$ 16 kHz [A]
SC6A062	2 × 4.5	2 × 4	2 × 3
SC6A162	2 × 10	2 × 9	2 × 5
SC6A261	19	15	8

Tab. 33: Nominal output current $I_{2N,PU}$ dependent on the clock frequency

Information

Select the defined clock frequency using parameter B24. The clock frequency for double-axis controllers always applies to both axis controllers.

7.1.4.2 Effect of the surrounding temperature

Derating as a function of the surrounding temperature is determined as follows:

- 0 °C to 45 °C: No restrictions ($D_T = 100\%$)
- 45 °C to 55 °C: Derating $-2.5\%/K$

Example

The drive controller needs to be operated at 50 °C.

The derating factor D_T is calculated as follows

$$D_T = 100\% - 5 \times 2.5\% = 87.5\%$$

7.1.4.3 Effect of the installation altitude

Derating as a function of the installation altitude is determined as follows:

- 0 m to 1000 m: No restriction ($D_{IA} = 100\%$)
- 1000 m to 2000 m: Derating $-1.5\%/100\text{ m}$

Example

The drive controller needs to be installed at an altitude of 1500 m above sea level.

The derating factor D_{IA} is calculated as follows:

$$D_{IA} = 100\% - 5 \times 1.5\% = 92.5\%$$

7.1.4.4 Calculating the derating

Follow these steps for the calculation:

1. Determine the highest clock frequency (f_{PWM}) that will be used during operation and use it to determine the nominal current $I_{2N,PU}$.
2. Determine the derating factors for installation altitude and surrounding temperature.
3. Calculate the reduced nominal current $I_{2N,PU(red)}$ in accordance with the following formula:

$$I_{2N,PU(red)} = I_{2N,PU} \times D_T \times D_{IA}$$

Example

A drive controller of type SC6A062 needs to be operated at a clock frequency of 8 kHz at an altitude of 1500 m above sea level and a surrounding temperature of 50 °C.

The nominal current of the SC6A062 at 8 kHz is 4 A per axis. The derating factor D_T is calculated as follows:

$$D_T = 100\% - 5 \times 2.5\% = 87.5\%$$

The derating factor D_{IA} is calculated as follows:

$$D_{IA} = 100\% - 5 \times 1.5\% = 92.5\%$$

The output current of importance for the project configuration is:

$$I_{2N,PU(red)} = 4 \text{ A} \times 0.875 \times 0.925 = 3.24 \text{ A}$$

7.1.5 Dimensions

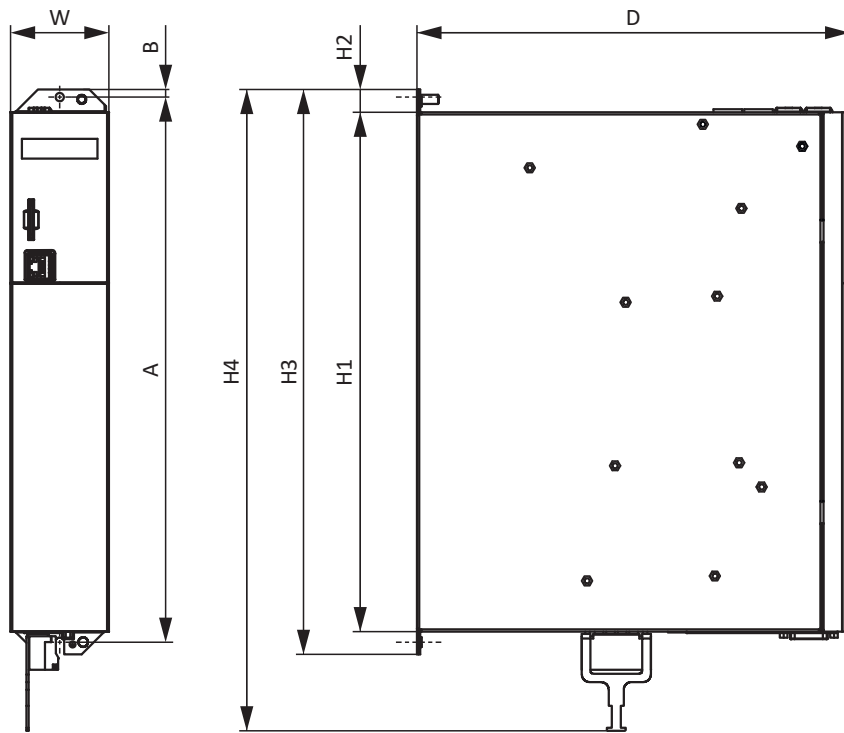

Fig. 6: SC6 dimensional drawing

Dimension			SC6A062	SC6A162	SC6A261
Drive controller	Width	W	45	65	
	Depth	D	265	286	
	Body height	H1	343		
	Fastening clip height	H2	15		
	Height incl. fastening clips	H3	373		
	Total height incl. shield connection	H4	423		
Fastening bores (M5)	Vertical distance	A	360+2		
	Vertical distance to the upper edge	B	5		

Tab. 34: SC6 dimensions [mm]

Take the additional installation depth of the rear section modules into account when calculating the overall dimensions.

7.1.6 Weight

Type	Weight without packaging [g]	Weight with packaging [g]
SC6A062	3600	5200
SC6A162	5300	6700
SC6A261	5200	6400

Tab. 35: SC6 weight [g]

7.2 DC link connection

The following chapters contain the technical data of the DL6B Quick DC-Link modules.

7.2.1 General technical data

The following information applies to all Quick DC-Link modules and corresponds to the general technical data for the base device.

Device features	
Protection class of the device	IP20 (if built over with drive controller or supply module)
Protection class	Protection class I in accordance with EN 61140 (if built over with drive controller or supply module)
Protection class of the installation space	At least IP54

Tab. 36: Device features

Transport and storage conditions	
Storage/ transport temperature	-20 °C to +70 °C Maximum change: 20 K/h
Relative humidity	Maximum relative humidity 85%, non-condensing
Vibration (transport) in accordance with EN 60068-2-6	5 Hz ≤ f ≤ 9 Hz: 3.5 mm 9 Hz ≤ f ≤ 200 Hz: 10 m/s ² 200 Hz ≤ f ≤ 500 Hz: 15 m/s ²
Fall height for free fall ⁶ Weight < 100 kg in accordance with EN 61800-2 (or IEC 60721-3-2, class 2M4)	0.25 m
Shock testing in accordance with EN 60068-2-27	Pulse shape: Half-sine Acceleration: 5 g Shock duration: 30 ms Number of shocks: 3 per axis

Tab. 37: Transport and storage conditions

Operating conditions	
Surrounding temperature during operation	0 °C to 45 °C with nominal data 45 °C to 55 °C with derating -2.5% / K
Relative humidity	Maximum relative humidity 85%, non-condensing
Installation altitude	0 m to 1000 m above sea level without restrictions 1000 m to 2000 m above sea level with -1.5%/100 m derating
Pollution degree	Pollution degree 2 in accordance with EN 50178
Vibration (operation) in accordance with EN 60068-2-6	5 Hz ≤ f ≤ 9 Hz: 0.35 mm 9 Hz ≤ f ≤ 200 Hz: 1 m/s ²

Tab. 38: Operating conditions

⁶ Only valid for components in their original packaging.

7.2.2 Assignment of DL6B to SC6

DL6B is available in the following designs suitable for the individual types:

Type	DL6B10	DL6B11
ID No.	56655	56656
SC6A062	X	—
SC6A162	—	X
SC6A261	—	X

Tab. 39: Assignment of DL6B to SC6

7.2.3 Dimensions

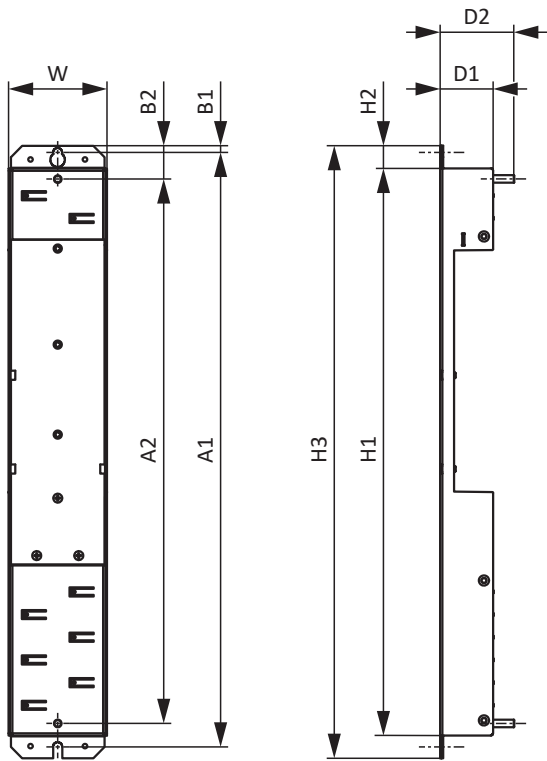

Fig. 7: DL6B dimensional drawing

Dimension		DL6B10	DL6B11
Quick DC-Link	Width	W	45
	Depth	D1	35
	Depth incl. attachment bolts	D2	49
	Height	H1	375
	Fastening clip height	H2	15
	Height incl. fastening clips	H3	405
Fastening bores	Vertical distance (wall mounting)	A1	393+2
	Vertical distance (module mounting)	A2	360
	Vertical distance to the upper edge	B1	4.5
	Vertical distance to the upper edge	B2	22

Tab. 40: DL6B dimensions [mm]

7.2.4 Weight

Type	Weight without packaging [g]	Weight with packaging [g]
DL6B10	440	480
DL6B11	560	600

Tab. 41: DL6B weight [g]

7.2.5 Copper rails

For the DC link connection of the Quick DC-Link modules of type DL6B, you need three copper rails with a cross-section of 5 × 12 mm in the correct length. The copper rails must comply with the requirements in accordance with either EN 12167 or EN 13601. The required length depends on the total width of the device group (see [Length of copper rails](#) [▶ 88]).

7.3 SR6 safety module

The SR6 option adds the STO safety function to the SC6 drive controller via terminal X12.

For double-axis controllers, the STO safety function has a two-channel structure that acts upon both axes.

Information

If you would like to use the STO safety function via terminals, be sure to read the manual for the SR6 safety module.

If you do not want to use the safety function, connect STO_a and STO_b to 24 V_{DC} and connect GND to the reference potential, e.g., using a connection with terminal X11.

Digital input	Electrical data
STO _a	U _{1max} = 30 V _{DC} (PELV) High level = 15 – 30 V _{DC} Low level = 0 – 8 V _{DC} I _{1max} = 100 mA I _{1N} = 10 – 15 mA per channel C _{1max} = 10 nF
STO _b	
STO _{status}	U ₂ = U ₁ – (1.5 Ω * I ₁) I _{2min} = 1 mA
STO _{status} supply	U ₁ = +24 V _{DC} , +20%/25% I _{1max} = 100 mA
GND	—

Tab. 42: X12 electrical data – Digital inputs

7.4 Operating motors

The drive controller supports rotational motors with a number of motor poles from 2 to 120 poles (1 through 60 pole pairs), as well as linear motors with pole pitches from 1 to 500 mm.

When selecting the motor, consider the technical data of the drive controller (output voltage range and clock frequency).

You can operate the following motors with the specified control modes.

Motor type	B20 Control mode	Encoders	Other settings	Characteristics
Lean motor	32: LM - sensorless vector control	No encoder required	—	Dynamics, high speed accuracy, constant speed, overcurrent protection
Synchronous servo motor, torque motor	64: SSM - vector control	Absolute encoder required: EnDat 2.1/2.2 digital, SSI, resolver, EnDat 3 or HIPERFACE DSL encoders	Without field weakening (B91 Field weakening = 0: Inactive)	High dynamics, high speed accuracy, very constant speed, high overcurrent protection
			With field weakening (B91 Field weakening = 1: Active)	High dynamics, high speed accuracy, very constant speed, high overcurrent protection, greater speed range, but also higher current requirement
	48: SSM-vector control incremental encoder	Incremental encoder required	Without field weakening (B91 Field weakening = 0: Inactive)	High dynamics, high speed accuracy, very constant speed, high overcurrent protection
			With field weakening (B91 Field weakening = 1: Active)	High dynamics, high speed accuracy, very constant speed, high overcurrent protection, greater speed range, but also higher current requirement
Synchronous linear motor	70: SLM - vector control	Linear encoder and commutation information required	—	High dynamics, high overcurrent protection
Asynchronous motor	2: ASM - vector control	Encoder required	—	High dynamics, high speed accuracy, very constant speed, high overcurrent protection
	3: ASM - sensorless vector control	No encoder required	—	Dynamics, speed accuracy, constant speed, overcurrent protection
	1: ASM - V/f-slip compensated		Linear characteristic curve (B21 V/f-characteristic = 0: Linear)	Very constant speed
			Quadratic characteristic curve (B21 V/f-characteristic = 1: Square)	Very constant speed, especially suitable for fan applications
	0: ASM - V/f-control		Linear characteristic curve (B21 V/f-characteristic = 0: Linear)	Very constant speed
			Quadratic characteristic curve (B21 V/f-characteristic = 1: Square)	Very constant speed, especially suitable for fan applications

Tab. 43: Motor types and control modes

Unsuitable drive controller/motor combinations

Lean motors of size 5 cannot be operated on drive controllers of size 0 (type SC6A062). Lean motors of size 7 cannot be operated on drive controllers of size 0 or 1 (type SC6A062 or SC6A162).

7.5 Evaluable encoders

The technical data of the evaluable encoder can be found in the following chapters.

7.5.1 Overview

Information

With **extended safety technology** (SX6 option), an encoder that meets the following requirements must be used for the safety functions with motion monitoring:

- The encoder must provide at least 4096 increments per revolution.
(Incremental encoders with 1024 increments per revolution achieve 4096 increments per revolution with the 4-fold internal drive controller evaluation and thus fulfill the requirement).
- The encoder must be able to provide a new position at least every 200 µs.

The overview table explains which connections are available for the various encoders.

Encoder	Connection	Note
EnDat 2.1 digital	X4	Not suitable for linear encoders
EnDat 2.2 digital	X4	The drive controller evaluates the information reported by the encoder and automatically detects whether the encoder of a rotational or linear motor is connected
SSI	X4	—
Incremental TTL	X4	TTL signals, differential
Incremental HTL	X4	With HT6 adapter for level conversion: HTL signals, differential
	X101	HTL signals, single-ended
	X103	HTL signals, single-ended
HTL pulse and direction	X101	HTL signals, single-ended
	X103	HTL signals, single-ended
HTL Hall sensor	X101	HTL signals, single-ended
	X103	HTL signals, single-ended
Resolvers	X4	—
EnDat 3	X4	In One Cable Solution (OCS) design
HIPERFACE DSL	X4	In One Cable Solution (OCS) design

Tab. 44: Encoder connections

7.5.2 Signal transmission

The signal levels of the encoder inputs and outputs apply to signal transmission.

7.5.2.1 Encoder inputs

The following signal levels apply to the encoder inputs for single-ended signal transmission:

Signal level	HTL, single-ended
Low level	0 to $8 V_{DC}$
High level	15 to $30 V_{DC}$

Tab. 45: Signal level encoder inputs, single-ended

The following signal levels apply to the encoder inputs for differential signal transmission:

Signal level	HTL, differential ⁷	TTL, differential (ANSI TIA/EIA-422)
Low level	-30 to $-4.2 V_{DC}$	-6 to $-0.2 V_{DC}$
High level	4.2 to $30 V_{DC}$	0.2 to $6 V_{DC}$

Tab. 46: Signal levels of encoder inputs, differential

7.5.3 X4: Encoder

ATTENTION!

Risk of encoder destruction!

The drive controller provides $12 V_{DC}$ for the encoder supply. Take this into account when selecting the encoder. Only connect an encoder that is made for operation with a supply voltage of $12 V_{DC}$.

Unsuitable encoder models

The following encoder models must **not** be connected due to their supply voltage:

Encoder model	Code according to type designation
ECI 1118	C0, C2
EQI 1130	Q0, Q2
ECI 1319	CR
EQI 1329	QP
EQI 1331	QR

Tab. 47: Encoder models with unsuitable supply voltage range

⁷ Encoder-side level at HTL to TTL adapter HT6

X4 – EnDat 2.1 digital encoders

Technical data	EnDat 2.1 digital signals
U_2	12 V _{DC} +/-5%
I_{2max}	250 mA
I_{2min}	—
Encoder type	Single-turn and multi-turn; not suitable for linear encoders
Clock frequency	2 MHz
Max. cable length	100 m, shielded

Tab. 48: X4 technical data – EnDat 2.1 digital signals

X4 – EnDat 2.2 digital encoders

Technical data	EnDat 2.2 digital signals
U_2	12 V _{DC} +/-5%
I_{2max}	250 mA
Encoder type	Single-turn and multi-turn
Clock frequency	4 MHz
Max. cable length	100 m, shielded

Tab. 49: X4 technical data – EnDat 2.2 digital signals

X4 – SSI encoders with free setting

Obey the instructions on the free setting of SSI encoders (see [SSI: Evaluation at X4 with free setting \(H00 = 78\)](#) [▶ 361]).

Technical data	SSI signals
U_2	12 V _{DC} +/-5%
I_{2max}	250 mA
Encoder type	Single-turn and multi-turn
Data length	Various resolutions possible
Clock frequency	150 – 1000 kHz
Sampling rate	250 μs
Monoflop time	10 – 100 μs
Code	Binary or gray
Transfer	Double or single
Max. cable length	100 m, shielded

Tab. 50: X4 technical data – SSI signals with free setting

X4 – SSI encoders with fixed setting

Obey the instructions on the fixed setting of SSI encoders (see [SSI: Evaluation at X4 with fixed setting \(H00 = 65\)](#) [▶ 362]).

Technical data	SSI signals
U_2	12 V _{DC} +/-5%
I_{2max}	250 mA
Encoder type	Single-turn and multi-turn
Data length	13, 24 or 25 bits
Clock frequency	250 or 600 kHz
Sampling rate	250 µs
Monoflop time	30 µs
Code	Binary or gray
Transfer	Double or single
Max. cable length	100 m, shielded

Tab. 51: X4 technical data – SSI signals with fixed setting

X4 – Incremental encoders

Technical data	Incremental signals
U_2	12 V _{DC} +/-5%
I_{2max}	250 mA
f_{max}	1 MHz
Signal level	TTL, differential
Max. cable length	100 m, shielded

Tab. 52: X4 technical data – TTL differential incremental signals

Information

Calculation example – Maximum frequency f_{max}

for an encoder with 2048 increments per revolution: 3000 revolutions per minute (equivalent to 50 revolutions per second)
 x 2048 increments per revolution = 102400 increments per second = 102.4 kHz << 1 MHz

Information

Using an HT6 adapter for level conversion from HTL signals to TTL signals, it is also possible to connect a differential HTL incremental encoder to terminal X4. Note that, with an external power supply, the maximum level of 20 V_{DC} for the HTL signals may not be exceeded.

X4 – Resolvers

Technical data	Resolver signals
Measuring range	$\pm 2.5 \text{ V}$
Resolution	12 bits
U_2	$\pm 10 \text{ V}$
$I_{2\text{max}}$	80 mA
f_2	7 – 9 kHz
P_{max}	0.8 W
Transfer ratio	$0.5 \pm 5\%$
Number of poles	2, 4, 6 and 8
Signal shape	Sine
Max. cable length	100 m, shielded

Tab. 53: X4 technical data – Resolver signals

X4 – EnDat 3 encoders (One Cable Solution)

Technical data	EnDat 3 signals
U_2	$12 \text{ V}_{\text{DC}} \pm 5\%$
$I_{2\text{max}}$	250 mA
Encoder type	Single-turn and multi-turn
Max. cable length	100 m, shielded

Tab. 54: X4 technical data – EnDat 3 signals

X4 – HIPERFACE DSL encoders (One Cable Solution)

Technical data	HIPERFACE DSL signals
U_2	$12 \text{ V}_{\text{DC}} \pm 5\%$
$I_{2\text{max}}$	250 mA
Encoder type	Single-turn and multi-turn
Max. cable length	100 m, shielded

Tab. 55: X4 technical data – HIPERFACE DSL signals

7.5.4 X101: Encoder

Feature	All sizes
Max. core/cable length	30 m

Tab. 56: Maximum core/cable length [m]

Electrical data	Digital input	Incremental, pulse/direction, Hall sensor signals
Low level	DI1 – DI4	0 – 8 V _{DC}
High level		15 – 30 V _{DC}
U _{1max}		30 V _{DC}
I _{1max}		16 mA
f _{1max}	DI1 – DI2	10 kHz
	DI3 – DI4	250 kHz

Tab. 57: X101 electrical data – Incremental signals, pulse/direction signals, Hall sensor signals, single-ended HTL

Information

Calculation example – Maximum frequency f_{max}

for an encoder with 2048 increments per revolution: 3000 revolutions per minute (equivalent to 50 revolutions per second) x 2048 increments per revolution = 102400 increments per second = 102.4 kHz < 250 kHz

7.5.5 X103: Encoder

Feature	All sizes
Max. core/cable length	30 m

Tab. 58: Maximum core/cable length [m]

Electrical data	Digital input	Incremental, pulse/direction, Hall sensor signals
Low level	DI6 – DI9	0 – 8 V _{DC}
High level		15 – 30 V _{DC}
U _{1max}		30 V _{DC}
I _{1max}		16 mA
f _{1max}	DI6 – DI7	10 kHz
	DI8 – DI9	250 kHz

Tab. 59: X103 electrical data – Incremental signals, pulse/direction signals, Hall sensor signals, single-ended HTL

Information

Calculation example – Maximum frequency f_{max}

for an encoder with 2048 increments per revolution: 3000 revolutions per minute (equivalent to 50 revolutions per second) x 2048 increments per revolution = 102400 increments per second = 102.4 kHz < 250 kHz

7.6 Controllable brakes

Without the SX6 safety module, the brake of axis A is connected to X2A. Connect the brake of axis B to X2B for double-axis controllers.

With the SX6 safety module, brake 1 and brake 2 must be assigned to terminals X2A and X2B in PASMotion Safety Configurator via the Safe Brake Control 2-pole (SBC) safety function.

You can control the following brakes:

- Directly connected 24 V_{DC} brakes
- Brakes connected indirectly over contactor

The brakes are supplied over X300.

Electrical data	Brake connection
U ₂	24 V _{DC} , +20%
I _{2max}	2.5 A
f _{2max}	1 Hz at I _N ≤ 2.1 A; 0.25 Hz at I _N > 2.1 A
E _{2max}	1.83 J

Tab. 60: X2 electrical data – Brake connection

Information

In the case of a nominal brake current > 2.1 A, the controller must ensure compliance with the maximum switching frequency of 0.25 Hz.

Information

Control modes 48: SSM-vector control incremental encoder and 70: SLM - vector control with commutation finding using Wake and Shake may only be used in combination with a brake for axes without gravity load.

For more information, see [B20 = 32, 48, 64, or 70](#) [▶ 212].

7.7 Evaluable motor temperature sensors

You can connect a PTC triplet at terminal X2 or a Pt1000 motor temperature sensor using the One Cable Solution to the SC6 drive controller.

Information

Evaluation of the temperature sensors is always active. If operation without a temperature sensor is permitted, the connections must be bridged to X2. Otherwise a fault is triggered when the device is switched on.

Type	Triggering limit
PTC thermistor	4000 Ω
Pt1000 temperature sensor	Can be parameterized in °C in parameter B39

Tab. 61: Triggering limit of temperature sensor

7.8 Braking resistor

In addition to drive controllers, STOBER offers the following braking resistors described below in various sizes and performance classes. For the selection, note the minimum permitted braking resistors specified in the technical data of the individual drive controller types.

7.8.1 Tubular fixed resistor FZMU, FZZMU

Type	FZMU 400×65	FZZMU 400×65
ID No.	49010	53895
SC6A062	X	—
SC6A162	(X)	X
SC6A261	(X)	X

Tab. 62: Assignment of FZMU, FZZMU braking resistor – SC6 drive controller

X	Recommended
(X)	Possible
—	Not possible

Properties

Technical data	FZMU 400×65	FZZMU 400×65
ID No.	49010	53895
Type	Tubular fixed resistor	Tubular fixed resistor
Resistance [Ω]	100 \pm 10%	47 \pm 10%
Thermal drift	\pm 10%	\pm 10%
Power [W]	600	1200
Therm. time const. τ_{th} [s]	40	40
Pulse power for < 1 s [kW]	18	36
U_{max} [V]	848	848
Weight without packaging [g]	2200	4170
Protection class	IP20	IP20
Marks and test symbols	cURus, CE, UKCA	cURus, CE, UKCA

Tab. 63: FZMU, FZZMU technical data

Dimensions

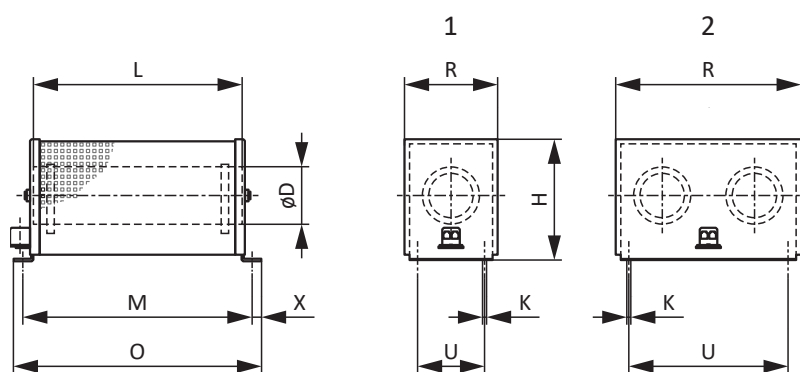

Fig. 8: FZMU (1), FZZMU (2) dimensional drawing

Dimension	FZMU 400×65	FZZMU 400×65
ID No.	49010	53895
L x D	400 × 65	400 × 65
H	120	120
K	6.5 × 12	6.5 × 12
M	430	426
O	485	485
R	92	185
U	64	150
X	10	10

Tab. 64: FZMU, FZZMU dimensions [mm]

7.8.2 GVADU, GBADU flat resistor

Type	GVADU 210×20	GBADU 265×30	GBADU 335×30
ID No.	55441	55442	55443
SC6A062	X	X	—
SC6A162	(X)	(X)	X
SC6A261	(X)	(X)	X

Tab. 65: Assignment of GVADU, GBADU braking resistor – SC6 drive controller

X	Recommended
(X)	Possible
—	Not possible

Properties

Technical data	GVADU 210×20	GBADU 265×30	GBADU 335×30
ID No.	55441	55442	55443
Type	Flat resistor		
Resistance [Ω]	100 \pm 10%	100 \pm 10%	47 \pm 10%
Thermal drift	\pm 10%	\pm 10%	\pm 10%
Power [W]	150	300	400
Therm. time const. τ_{th} [s]	60	60	60
Pulse power for < 1 s [kW]	3.3	6.6	8.8
U_{max} [V]	848	848	848
Cable design	Radox	FEP	FEP
Cable length [mm]	500	1500	1500
Conductor cross-section [AWG]	18/19 (0.82 mm ²)	14/19 (1.9 mm ²)	14/19 (1.9 mm ²)
Weight without packaging [g]	300	930	1200
Protection class	IP54	IP54	IP54
Marks and test symbols	cURus, CE, UKCA		

Tab. 66: GVADU, GBADU technical data

Dimensions

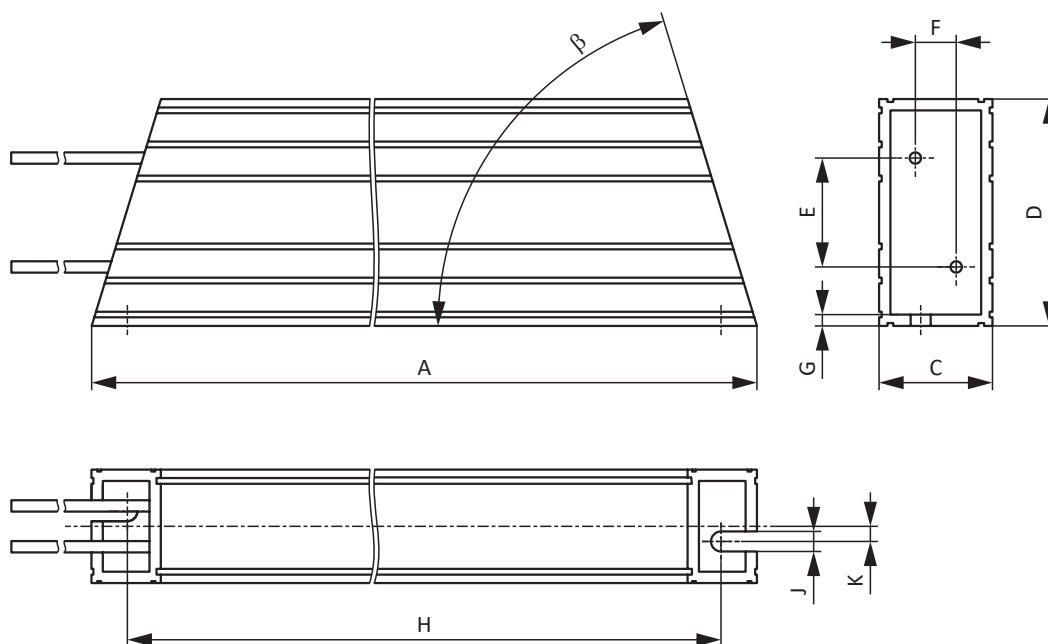

Fig. 9: GVADU, GBADU dimensional drawing

Dimension	GVADU 210×20	GBADU 265×30	GBADU 335×30
ID No.	55441	55442	55443
A	210	265	335
H	192	246	316
C	20	30	30
D	40	60	60
E	18.2	28.8	28.8
F	6.2	10.8	10.8
G	2	3	3
K	2.5	4	4
J	4.3	5.3	5.3
β	65°	73°	73°

Tab. 67: GVADU, GBADU dimensions [mm]

7.9 Choke

Technical specifications for suitable chokes can be found in the following chapters.

7.9.1 TEP output choke

Output chokes are required for connecting size 0 to 2 drive controllers to synchronous servo motors or asynchronous motors from a cable length > 50 m in order to reduce interference pulses and protect the drive system. If Lean motors are connected, output chokes must not be used.

Information

The following technical data only applies to a rotating magnetic field frequency of 200 Hz. For example, this rotating magnetic field frequency is achieved with a motor with 4 pole pairs and a nominal speed of 3000 rpm. Always observe the specified derating for higher rotating magnetic field frequencies. Also observe the relationship with the clock frequency.

Properties

Technical data	TEP3720-0ES41	TEP3820-0CS41	TEP4020-0RS41
ID No.	53188	53189	53190
Voltage range	3 × 0 to 480 V _{AC}		
Frequency range	0 – 200 Hz		
Nominal current I _{N,MF} at 4 kHz	4 A	17.5 A	38 A
Nominal current I _{N,MF} at 8 kHz	3.3 A	15.2 A	30.4 A
Max. permitted motor cable length with output choke	100 m		
Max. surrounding temperature $\vartheta_{amb,max}$	40 °C		
Protection class	IP00		
Winding losses	11 W	29 W	61 W
Iron losses	25 W	16 W	33 W
Connection	Screw terminal		
Max. conductor cross-section	10 mm ²		
UL Recognized Component (CAN; USA)	Yes		
Marks and test symbols	cURus, CE		

Tab. 68: TEP technical data

Dimensions

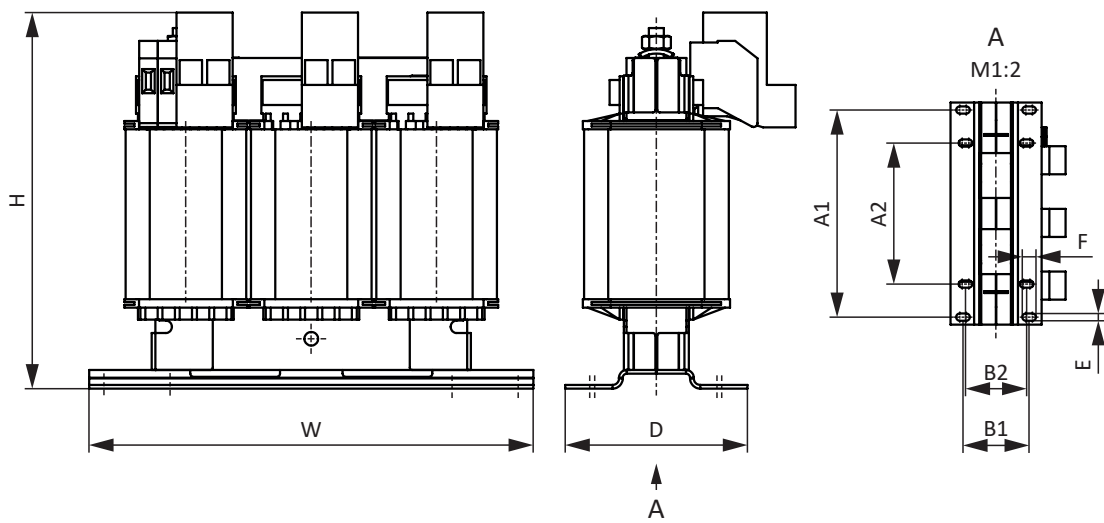

Fig. 10: TEP dimensional drawing

Dimension	TEP3720-OES41	TEP3820-OCS41	TEP4020-ORS41
Height H [mm]	Max. 150	Max. 152	Max. 172
Width W [mm]	178	178	219
Depth D [mm]	73	88	119
Vertical distance – A1 fastening bores [mm]	166	166	201
Vertical distance – A2 fastening bores [mm]	113	113	136
Horizontal distance – B1 fastening bores [mm]	53	68	89
Horizontal distance – B2 fastening bores [mm]	49	64	76
Drill holes – Depth E [mm]	5.8	5.8	7
Drill holes – Width F [mm]	11	11	13
Screw connection – M	M5	M5	M6
Weight without packaging [g]	2900	5900	8800

Tab. 69: TEP dimensions and weight

8 Project configuration

Relevant information on the project configuration and design of your drive system can be found in the following chapters.

EPLAN macros for all 6th generation drive controllers and their accessories are available in the EPLAN Data Portal for efficient planning and support of your project configuration.

8.1 Drive controllers

Minimum time between 2 energizing processes

The drive controllers have temperature-dependent resistors in the charging circuit that prevent the devices from being damaged when being connected to the grid after a fault, such as a short-circuited DC link, incorrect wiring, etc. These resistors are heated when charging the DC link. In order to prevent overloading, a specified, minimum time period must be maintained between energizing two devices.

Information

For the time span between two energizing processes, note that:

- Direct, repeat activation of the supply voltage is possible for cyclical power-on/power-off operation.
- A time span of > 15 minutes must be observed between two energizing processes during cyclical power-on/power-off operation with increased charging capacity.

Information

The STO safety function is available for safe stopping as an alternative to continuous, cyclical power-on/power-off operation.

8.2 DC link connection

Braked motors work like generators: Operating with an active drive controller, they convert kinetic energy from movement into electrical energy. This electrical energy is stored in the DC link capacitors of the drive controller. It can be supplied to powered motors with connected DC circuits and be used efficiently as a result.

However, capacitors in the DC link can only accept a limited amount of energy. The DC link voltage increases when a motor decelerates. If the DC link voltage rises above a defined limit, a chopper circuit is activated that tries to convert the excess energy into heat by means of a connected braking resistor. If the permitted maximum voltage is nonetheless reached, any possible damage must be prevented. The drive controller switches to the Fault state and shuts down.

In a DC link connection, the DC link capacitors of the drive controllers involved are connected in parallel. As a result, the maximum acceptable amount of energy increases in the DC link in comparison to a single unit.

The DC link connection can help save energy and reduce costs, especially in coil winding technology or during regular acceleration and braking cycles.

8.2.1 Information on design and operation

In order to connect the capacitors of multiple drive controllers, you need a separate Quick DC-Link module of type DL6B for each drive controller in the group.

Information

Note that Quick DC-Link can be subject to system or country-specific standards.

Central braking resistor

During a controlled emergency stop, all drive controllers may brake at the same time. During the design phase, check whether a central braking resistor is necessary to be able to stop certain system parts safely within a prescribed time.

Electrical data of the drive controllers

The electrical data of the individual types of drive controllers must be observed in the design and operation of the DC link connection, including the following in particular:

- Self-capacitance C_{pU}
- Charging capacity $C_{N,PU}$
- Nominal input current $I_{1N,PU}$
- Derating of the nominal input current

You can find the values in the technical data for the drive controllers.

Maximum voltage and maximum current

The maximum DC link voltage is $750 V_{DC}$ and the maximum permitted overall current is 200 A.

Protective measures

Note the information in the following chapters:

- [Power supply with DC link connection \[▶ 96\]](#)
- [Line fuses for DC link connection \[▶ 97\]](#)
- [Grid connection for DC link connection \[▶ 99\]](#)

8.2.2 Design

Charging capacity

The charging circuit integrated into a drive controller can charge the DC links of other drive controllers in addition to its own DC link.

Information

When designing the DC link connection, note that the sum of the charging capacities of the drive controllers connected to the grid is greater than or equal to the sum of the self-capacitances of all drive controllers in the DC link group.

Example – Checking the charging capacity of drive controllers connected to the grid

A SC6A261 drive controller connected to the grid is intended to charge another SC6A261 drive controller.

The DC link capacitance in the group to be charged corresponds to the sum of the self-capacitance values C_{pU} of all drive controllers in the group: $2 \times 940 \mu\text{F} = 1880 \mu\text{F}$.

The nominal charging capacity $C_{N,PU}$ of the drive controller connected to the grid is $1400 \mu\text{F}$.

Information

If a time span of ≥ 15 min is maintained between two energizing processes, the charging capacity increases to the maximum charging capacity C_{maxPU} .

The maximum charging capacity C_{maxPU} of the drive controller connected to the grid is $1880 \mu\text{F}$.

In this case, Quick DC-Link is permitted only if the minimum time of 15 min between two energizing processes is maintained.

Current load capacity of the input rectifiers

Information

When designing the DC link connection, note that the required supply current does not exceed the maximum supply current in total.

$$I_{\text{minLINE}} < I_{\text{maxLINE}}$$

For calculating the effective as well as maximum supply current, SERVOSOFT is helpful mechanical and electrical design software for drive systems.

Calculating supply current for motors

The necessary supply current for motors can be determined using the required drive output:

$$P_{\text{LINE}} \cong P_{\text{totalMOT}}$$

Calculating motor rating and voltage

The following formulas and assumptions are used to calculate the motor rating and voltage:

$$P_{\text{MOT}} = \sqrt{3} \times U_{\text{MOT}} \times I_{\text{MOT}} \times \cos \varphi_{\text{MOT}}$$

$$P_{\text{Line}} = \sqrt{3} \times U_{\text{Line}} \times I_{\text{Line,nec}} \times \lambda_{\text{Line}}$$

$$U_{\text{maxMOT}} = 0,8 \times U_{\text{LINE}}$$

$$I_{\text{minLINE}} = \frac{U_{\text{MOT}}}{U_{\text{LINE}}} \times I_{\text{MOT}} \times \frac{\cos \varphi_{\text{MOT}}}{\lambda_{\text{LINE}}}$$

In addition, the field weakening range begins.

The active factor for a synchronous servo motor ($\cos \varphi_{\text{MOT}}$) is about 0.9 in 4 kHz operation and about 0.98 in 8 kHz operation. The active factor of an asynchronous motor can be determined according to the accompanying electrical data.

The following is true for the power factor of the supply grid:

$$\lambda_{\text{LINE}} = 0,6 \rightarrow I_{\text{LINE}} < 40\text{A}$$

$$\lambda_{\text{LINE}} = 0,7 \rightarrow I_{\text{LINE}} > 40\text{A}$$

The required motor rating must be calculated in order to determine the necessary supply current and the number and sizes of the drive controllers to be connected to the grid as part of the design.

The overall maximum permitted input current I_{maxLINE} is the sum of the maximum input currents of all connected drive controllers in continuous operation. Dynamic movements of the connected motors are possible in the permitted range.

The following is true for the sum of the input currents of the connected drive controllers:

- If the respective power of all drive controllers connected to the grid is identical, the sum of the maximum input currents in the network is calculated using the formula

$$I_{\text{maxLINE}} = 0,8 \times n_{\text{fed}} \times I_{\text{IN,PU}}$$

- If the respective power of all drive controllers connected to the grid differs, the sum of the input current is calculated by multiplying the input current of the smallest drive controller connected to the grid by the number of connected drive controllers

$$I_{\text{maxLINE}} = 0,9 \times n_{\text{fed}} \times I_{\text{IN,PUmin}}$$

To prevent current asymmetry, all drive controllers connected to the grid with different ratings must contain the same fuse protection, which in turn must correspond to the drive controller with the least power.

Current load capacity of the copper rails

DC rails connect the DC link capacitors of the drive controllers with one another. They are copper rails that are installed using the quick fastening clamps. DC rails must have a cross-section of 5×12 mm. The maximum permitted current load capacity of the copper rails is 200 A.

Wiring example

The example in the attachment (see [Wiring examples](#) [▶ 358]) illustrates the basic connection to Quick DC-Link DL6B based on a DC link connection.

8.3 Mixed operation

You can combine the drive controller with other 6th generation STOBER drive controllers.

For a DC link connection, however, only devices of the same series (e.g. SB6) and of same type (e.g. SB6A26) may be supplied with power.

For example, two SB6A26 drive controllers are to be coupled with one SC6A062 drive controller in the DC link. In this case, both SB6A26 drive controllers are connected to the supply grid. The SC6A062 drive controller may only be connected to the DC link of the SB6A26 drive controllers in this case, not to the supply grid.

Coupling via Quick DC-Link

The graphic below shows an example of the grounding concept in mixed operation when using Quick DC-Link rear section modules. The grounding conductor connection between the drive controller and associated DL6B Quick DC-Link rear section module is made using the metallic connection of the housings. The grounding conductor connection between the DL6B type rear section modules is established using a copper rail (PE rail).

Obey the requirements for connecting the protective grounding conductor to a drive controller connected to the grid (see [Protective grounding \[► 101\]](#)).

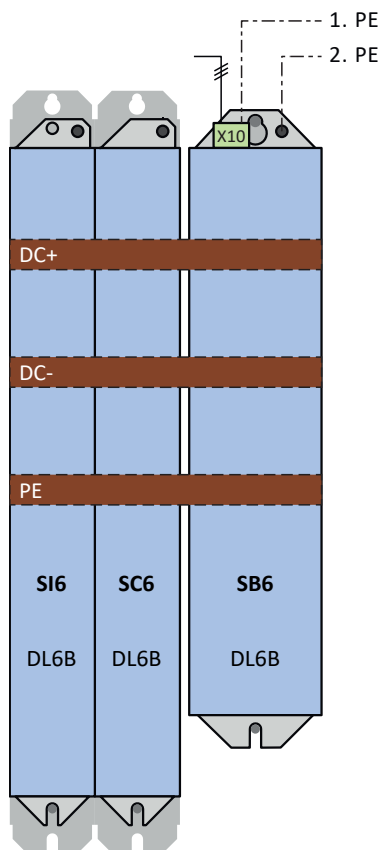

Fig. 11: Grounding concept in mixed operation of SI6 and SC6 with powered SB6 drive controller

Coupling via terminal X22

If you would like to connect two drive controllers via terminal X22, there are special requirements for the connecting wiring:

- The connection cables must have a nominal voltage of at least U_0/U : 450/ 750 V_{DC}, e.g. requirement H07V-K.
- The connection lines have to be implemented as twisted pairs.
- At line lengths of 30 cm or more, the lines also must be implemented with shielding and the shield must be applied over a wide area in the immediate vicinity of the drive controller.
- Select the maximum permissible conductor cross-section (with or without end sleeve, depending on the design) of the drive controller with the smaller size as the conductor cross-section.
- Obey the terminal specifications for terminal X22 (see [Terminal specifications \[▶ 352\]](#)).

Obey the requirements for connecting the grounding conductor (see [Protective grounding \[▶ 101\]](#)).

8.4 Motor

During the project configuration for motors, note the framework conditions described below.

Rotational motors (Lean motors, synchronous servo motors, asynchronous motors, torque motors)

The maximum possible motor speed is limited to 36000 rpm.

The following relationship applies:

Rotating magnetic field frequency = Motor speed × Number of pole pairs ÷ 60

Since the output frequency f_{2pU} can be a maximum of 700 Hz, the motor speed can only be reached if the calculated rotating magnetic field frequency is less than f_{2pU} .

Translational motors (linear motors)

The maximum possible motor velocity is limited to 20,000 m/min.

The following relationship applies:

Field frequency = Velocity in m/min × 1000 ÷ (60 ÷ pole distance in mm)

Since the output frequency f_{2pU} can be a maximum of 700 Hz, the motor velocity can only be reached if the calculated field frequency is less than f_{2pU} .

8.5 Choke

For project configuration of the chokes, note the general conditions described below.

8.5.1 TEP output choke

Select the output chokes in accordance with the nominal currents of the output chokes, motor and drive controller. In particular, observe the derating of the output choke for rotating magnetic field frequencies higher than 200 Hz. You can calculate the rotating magnetic field frequency for your drive with the following formula:

$$f_N = n_N \times \frac{p}{60}$$

Derating – Effect of the clock frequency

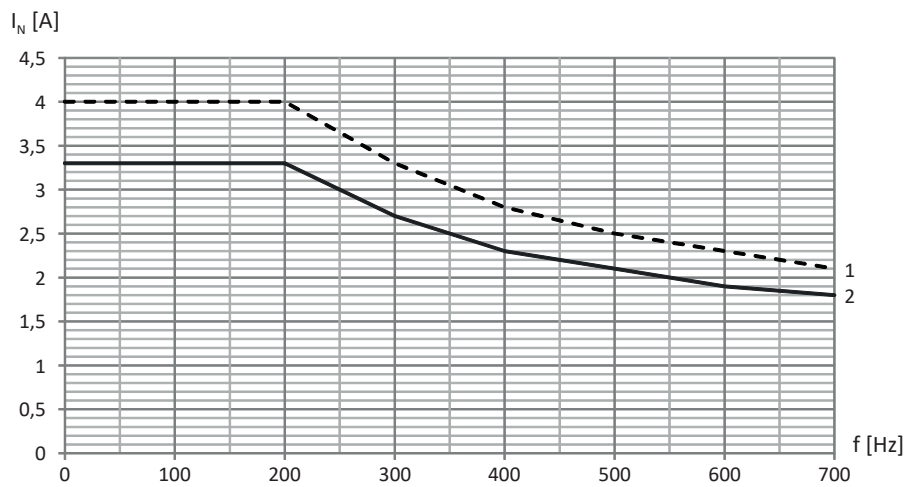

Fig. 12: Derating the nominal current depending on the clock frequency, TEP3720-0ES41

- 1 4 kHz clock frequency
- 2 8 kHz clock frequency

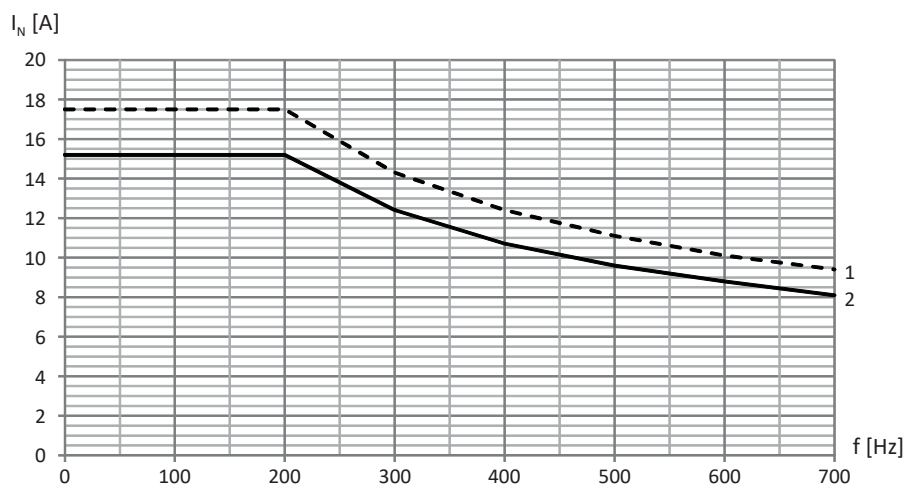

Fig. 13: Derating the nominal current depending on the clock frequency, TEP3820-0CS41

- 1 4 kHz clock frequency
- 2 8 kHz clock frequency

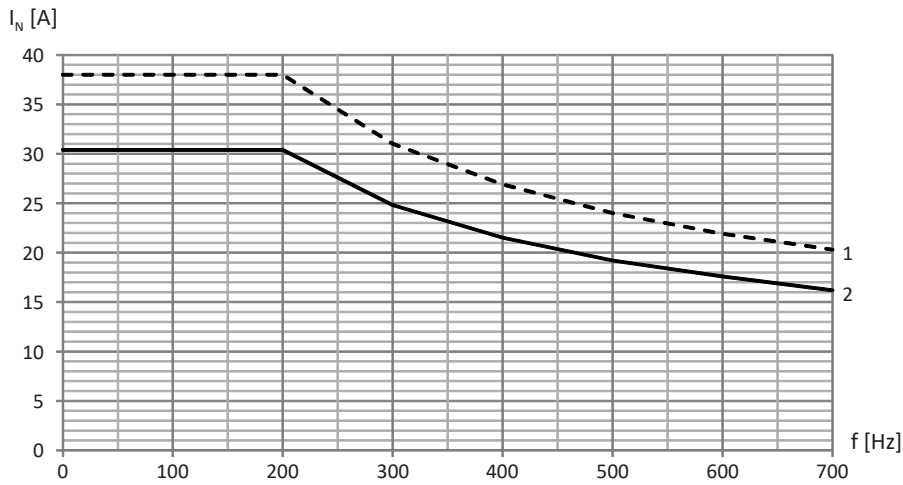

Fig. 14: Derating the nominal current depending on the clock frequency, TEP4020-ORS41

- 1 4 kHz clock frequency
- 2 8 kHz clock frequency

Derating – Effect of surrounding temperature

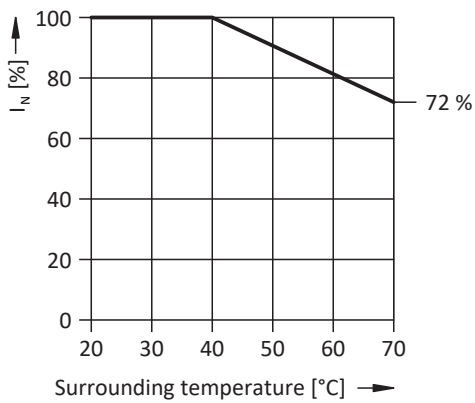

Fig. 15: Derating the nominal current based on surrounding temperature

Derating – Effect of the installation elevation

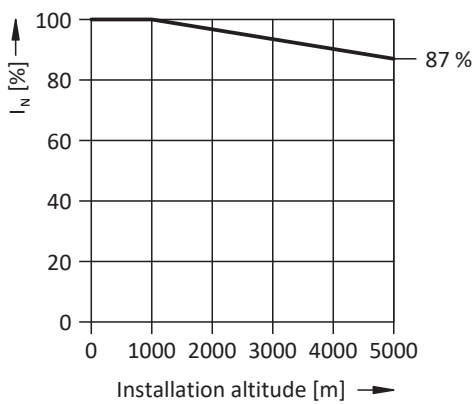

Fig. 16: Derating the nominal current depending on installation elevation

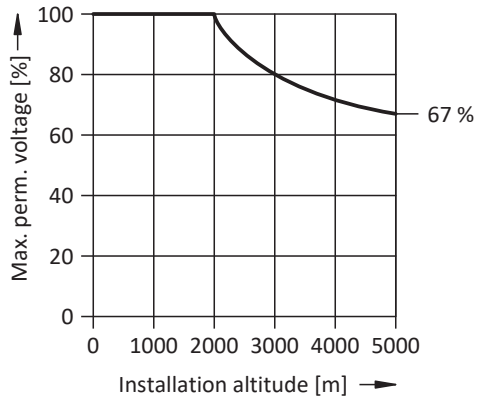

Fig. 17: Derating the voltage depending on installation elevation

9 Storage

Store the products in a dry and dust-free room if you do not install them immediately.

9.1 Drive controllers

The DC link capacitors can lose their electrical strength due to long storage times and must be reformed before commissioning.

ATTENTION!

Material damage due to reduced electrical strength!

Reduced electrical strength can cause considerable material damage when switching on the drive controller.

- Reform drive controllers in storage annually or before commissioning.

9.1.1 Annual reforming

To prevent damage to stored drive controllers, STOBER recommends connecting stored devices to the supply voltage once per year for one hour.

The following graphics show the basic line connection for 3-phase devices.

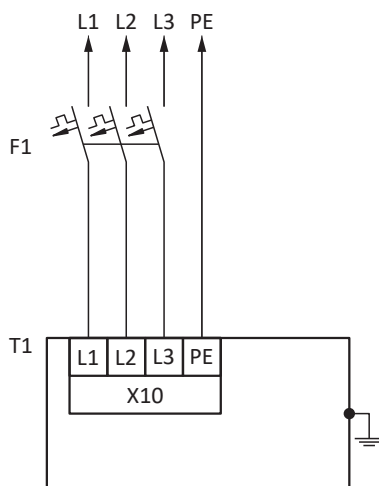

L1 – L3	Lines 1 to 3
N	Neutral conductor
PE	Grounding conductor
F1	Fuse
T1	Drive controller

Information

For UL-compliant operation: The connections marked with PE are intended solely for the functional grounding.

9.1.2 Reforming before commissioning

If annual reforming is not possible, implement reforming on stored devices before commissioning. Note that the voltage levels depend on the storage time.

The following graphic shows the predominant supply connection.

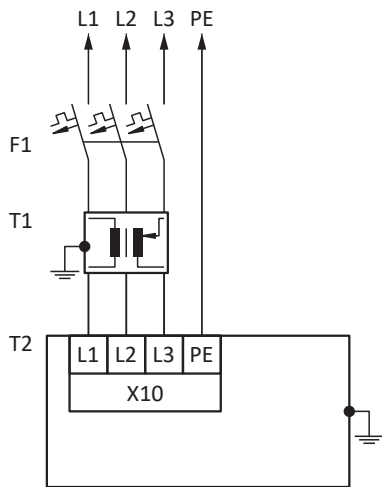

- L1 – L3 Lines 1 to 3
- N Neutral conductor
- PE Grounding conductor
- F1 Fuse
- T1 Variable transformer
- T2 Drive controller

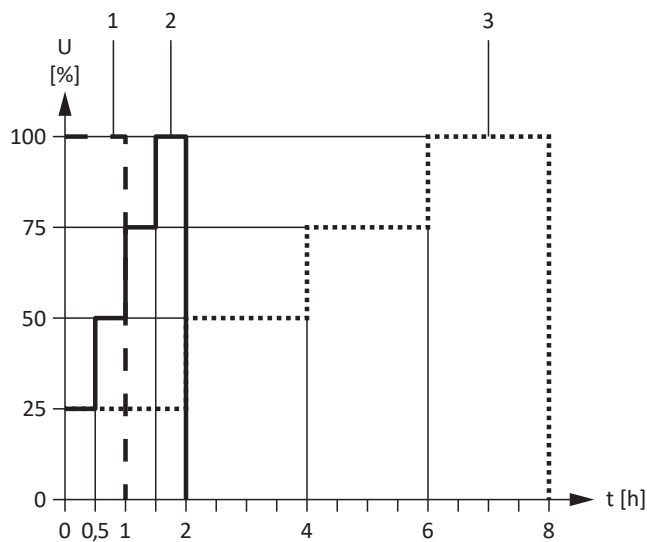

Fig. 18: Voltage levels dependent on storage time

- | | | |
|---|------------------------------|---|
| 1 | Storage time of 1 – 2 years: | Apply voltage for 1 hour before switching on. |
| 2 | Storage time of 2 – 3 years: | Implement reforming according to the graph before switching on. |
| 3 | Storage time ≥ 3 years: | Implement reforming according to the graph before switching on. |
| | Storage time < 1 year: | No actions required. |

Information

For UL-compliant operation: The connections marked with PE are intended solely for the functional grounding.

10 Installation

The following chapters describe the installation of a drive controller and the available accessories.

For information on replacing a drive controller, see [Replacement](#) [▶ 338].

10.1 Basic assembly instructions

Note the points described below for installation.

10.1.1 Drive controllers

Note the following points for installation:

- Prevent condensation, e.g. with anti-condensation heating elements.
- For reasons related to EMC, use installation plates with a conductive surface (unpainted, etc.).
- Avoid installation above or in the immediate vicinity of heat-generating devices, e.g. output chokes or braking resistors.
- To ensure there is sufficient air circulation in the control cabinet, observe the minimum clearances.
- Install the devices vertically.

Reference code

Affix a sticker to the designated field on the front of the device containing the unique reference code of the respective device and – with extended safety technology – the CRC checksum of the safety functions (S09[2]) to avoid confusion during installation or replacement.

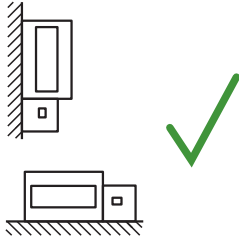

Fig. 19: Fields on the front of the device for identification

10.1.2 Braking resistor

Note the permitted mounting positions for the braking resistor.

FZMU, FZZMU tubular fixed resistor



Permitted installation:

- On vertical surfaces with terminals downwards
- On horizontal surfaces
- In control cabinets



Impermissible installation:

- On vertical surfaces with terminals upwards, left or right
- Outside of control cabinets

GVADU, GBADU flat resistor

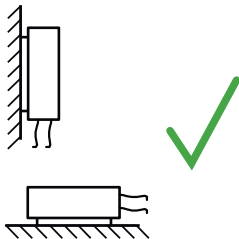

Permitted installation:

- On vertical surfaces with cables downwards
- On horizontal surfaces
- Installation outside of the control cabinet possible for mechanical protection of the conductors



Impermissible installation:

- On vertical surfaces with cables upwards

10.1.3 Choke

In relation to the flow of cooling air, the following mounting positions are permitted for the TEP output choke:

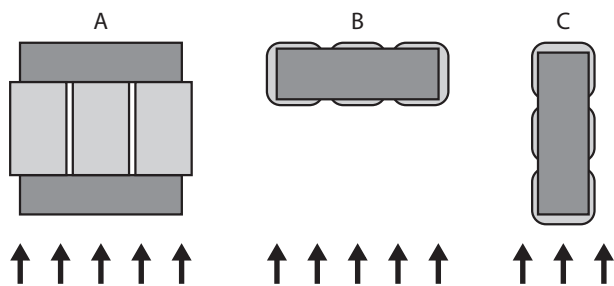

10.2 Minimum clearances

Note the minimum clearances for installation below.

Drive controller

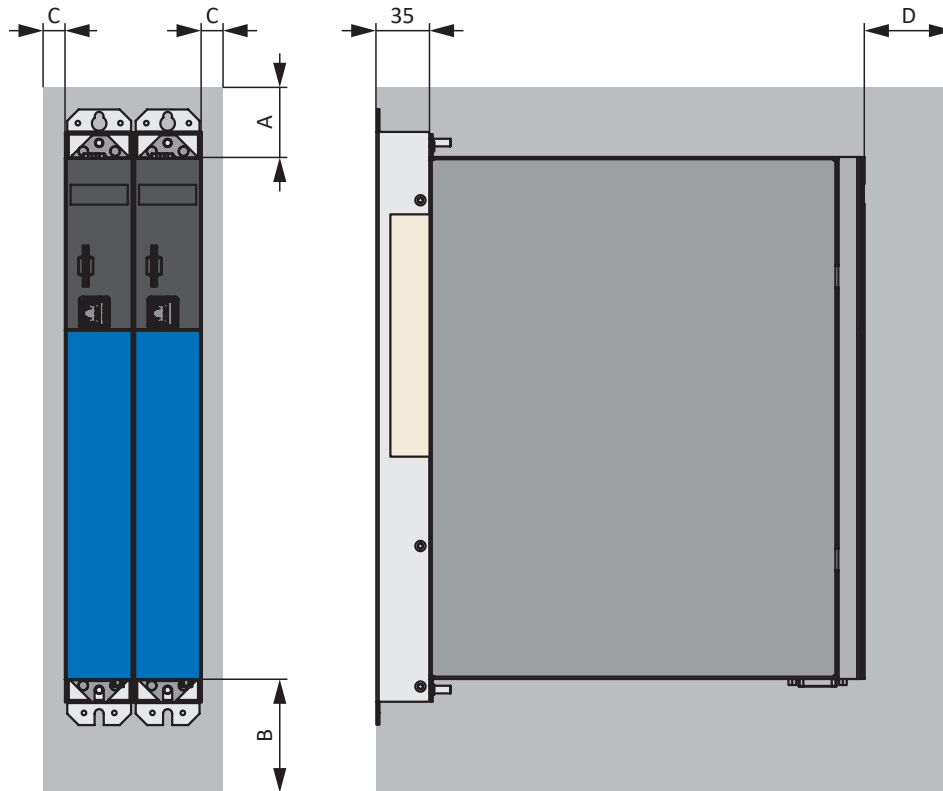

Fig. 20: Minimum clearances

Take into account the additional installation depth of 35 mm for the optional Quick DC-Link DL6B rear section modules.

The dimensions specified in the table relate to the outer edges of the drive controller.

Minimum clearance	A (above)	B (below)	C (on the side)	D (in front)
All sizes	100	200	5	50 ⁸

Tab. 70: Minimum clearances [mm]

Chokes and filters

Avoid installation below drive controllers or supply modules. For installation in a control cabinet, a distance of approximately 100 mm to other neighboring components is recommended. This distance ensures proper heat dissipation for chokes and filters.

Braking resistors

Avoid installation below drive controllers or supply modules. In order for heated air to flow out unimpeded, a minimum clearance of approximately 200 mm must be maintained in relation to neighboring components or walls and approximately 300 mm must be maintained to components above or ceilings.

⁸ Minimum clearance to be taken into account for permanent connection of the X9 service interface

10.3 Drilling diagrams and bore dimensions

Drilling diagrams and dimensions can be found in the following chapters.

10.3.1 Drive controllers

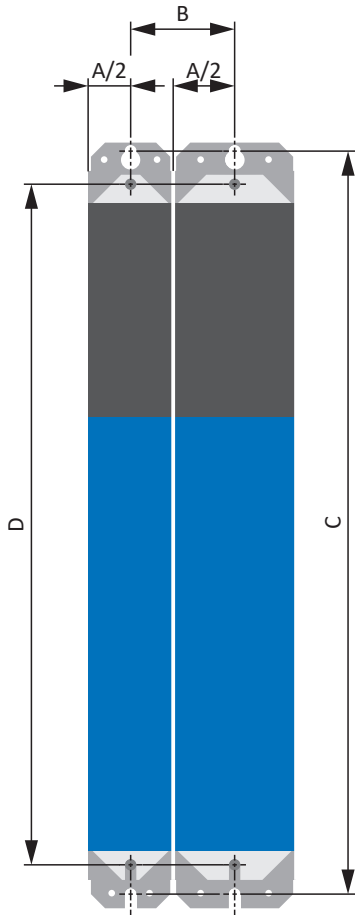

Fig. 21: SC6 and DL6B drilling diagram

The drilling dimensions depend on the selected design.

The following specifications apply to installation without a rear section module:

Dimension		SC6A062	SC6A162, SC6A261
Horizontal fastening bores Ø 4.2 (M5)	A	45	65
	B	Size 0	46±1
	B	Size 1, size 2	56±1
Vertical fastening bores Ø 4.2 (M5)	C	360+2	360+2

Tab. 71: Drilling dimensions for SC6 drive controller [mm]

The following specifications apply to installation with Quick DC-Link DL6B:

Dimension		DL6B10	DL6B11
Horizontal fastening bores Ø 4.2 (M5)	A	45	65
	B	Size 0	46±1
	B	Size 1, size 2	56±1
Vertical fastening bores Ø 4.2 (M5)	D	393+2	393+2

Tab. 72: Drilling dimensions for Quick DC-Link DL6B [mm]

10.3.2 Braking resistor

10.3.2.1 FZMU, FZZMU tubular fixed resistor

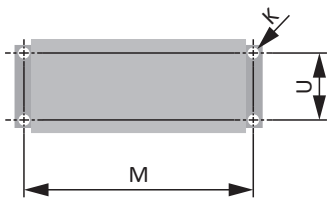

Fig. 22: FZMU, FZZMU drilling diagram

Dimension	FZMU 400×65	FZZMU 400×65
K	6.5 × 12	6.5 × 12
M	430	426
U	64	150

Tab. 73: FZMU, FZZMU drilling dimensions [mm]

10.3.2.2 GVADU, GBADU flat resistor

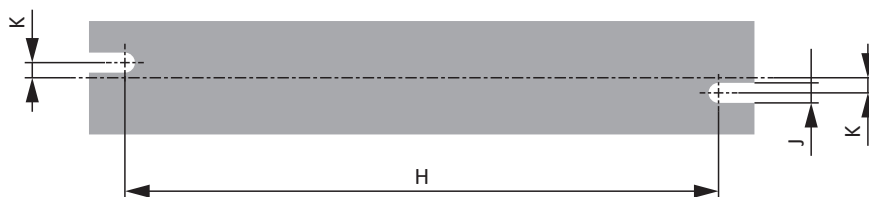

Fig. 23: GVADU, GBADU drilling diagram

Dimension	GVADU 210×20	GBADU 265×30	GBADU 335×30
H	192	246	316
K	2.5	4	4
J	4.3	5.3	5.3

Tab. 74: GVADU, GBADU drilling dimensions [mm]

10.3.3 Choke

10.3.3.1 TEP output choke

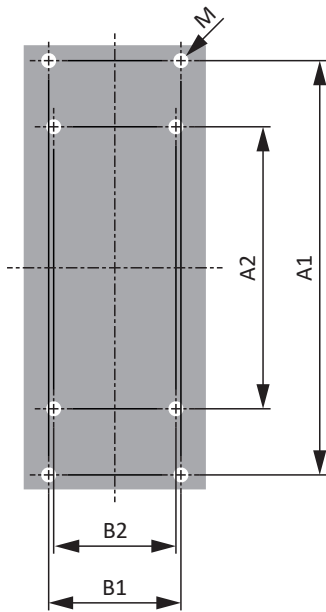

Fig. 24: TEP drilling diagram

Dimension	TEP3720-OES41	TEP3820-OCS41	TEP4020-ORS41
Vertical distance – A1 fastening bores [mm]	166	166	201
Vertical distance – A2 fastening bores [mm]	113	113	136
Horizontal distance – B1 fastening bores [mm]	53	68	89
Horizontal distance – B2 fastening bores [mm]	49	64	76
Drill holes – Depth E [mm]	5.8	5.8	7
Drill holes – Width F [mm]	11	11	13
Screw connection – M	M5	M5	M6

Tab. 75: TEP drilling dimensions

10.4 Length of copper rails

For the installation of the Quick DC-Link modules, you require three prepared copper rails with a cross-section of 5 × 12 mm.

The length of the copper rails is 5 mm shorter than the total width of the group, i.e. the total width of all DL6B Quick DC-Link modules present in the group:

$$B = A - 5 \text{ mm}$$

Note that the correct length of the copper rails can be determined only after installation of all modules:

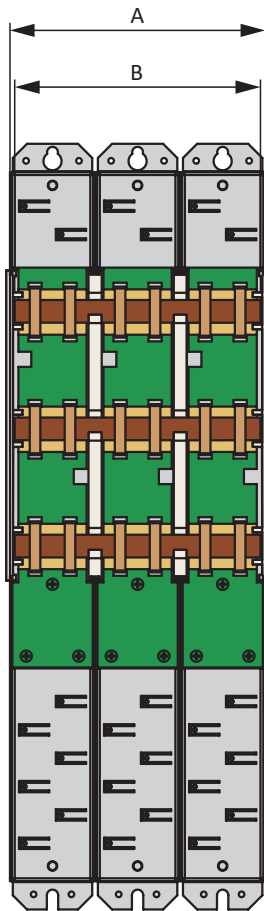

Fig. 25: Determination of the correct length of the copper rails

- A Total width of the group after installation
- B Length of the copper rails = A – 5 mm

10.5 Installing the drive controller without a rear section module

This chapter describes the installation of the SC6 drive controller without a rear section module.

If you would like to connect the drive controllers in the DC link, you must first mount the Quick DC-Link modules of type DL6B and then build the appropriate drive controllers over them.

WARNING!

Electrical voltage! Risk of fatal injury due to electric shock!

Hazardous voltages may be present on the connection terminals and the cores connected to them.

- Always switch off all power supply voltage before working on the devices!
- Note the discharge time of the DC link capacitors in the general technical data. You can only determine the absence of voltage after this time period.

Information

Note that drive controllers in storage require reforming each year or before commissioning at the latest.

Tools and material

You will need:

- Fastening screws
- Tool for tightening the fastening screws

Requirements and installation

Perform the following steps for each drive controller within the group and in the specified order.

- ✓ In accordance with the drilling diagram, taking into consideration the various device dimensions, you have made threaded holes for the threaded bolts on the mounting plate at the mounting position.
 - ✓ The mounting plate has been cleaned (free of oil, grease and swarf).
1. Fasten the top of the drive controller on the mounting plate.
 2. Fasten the bottom of the drive controller on the mounting plate.
 3. Connect the grounding conductor to the ground bolt. Obey the instructions and requirements for [Protective grounding](#) [▶ 101].
- ⇒ The installation is completed. In the next step, connect the drive controller.

10.6 Installing the DC link connection

If you would like to connect the drive controllers in the DC link group, you must first mount the Quick DC-Link modules of type DL6B and then build the appropriate drive controllers over them.

You can find an overview of the required hardware components in the attachment.

 WARNING!**Electrical voltage! Risk of fatal injury due to electric shock!**

Hazardous voltages may be present on the connection terminals and the cores connected to them.

- Always switch off all power supply voltage before working on the devices!
- Note the discharge time of the DC link capacitors in the general technical data. You can only determine the absence of voltage after this time period.

Tools and material

You will need:

- 3 copper rails with sufficient length and a cross-section of 5 × 12 mm (see [Length of copper rails](#) [▶ 88])
- The nut and washer assemblies (M5) as well as the quick fastening clamps included with the Quick DC-Link modules
- The insulation end sections for the left and right termination of the group that are available separately
- Fastening screws and tool for tightening the fastening screws

Requirements and installation

Perform the following steps in the specified order.

- ✓ You have tapped holes for fastening screws on the mounting plate at the installation position (in accordance with the drilling diagram for the respective device dimensions).
 - ✓ The mounting plate has been cleaned (free of oil, grease and swarf).
 - ✓ The copper rails must be straight, smooth, free of burrs and cleaned (free of oil and grease).
1. Fasten the Quick DC-Link modules onto the mounting plate with the fastening screws.

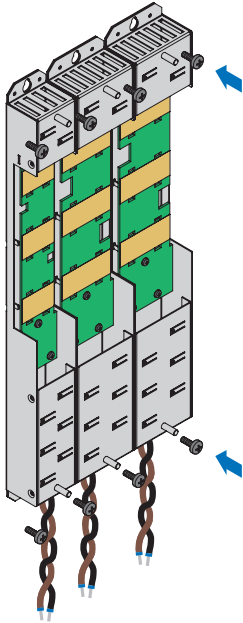

2. Insert the insulation connection pieces between the modules and insulation end section each at the left edge of the first module and at the right edge of the last module. Ensure correct alignment of the end section using the marking on the outside and the insertion aids for the copper rails on the inside.

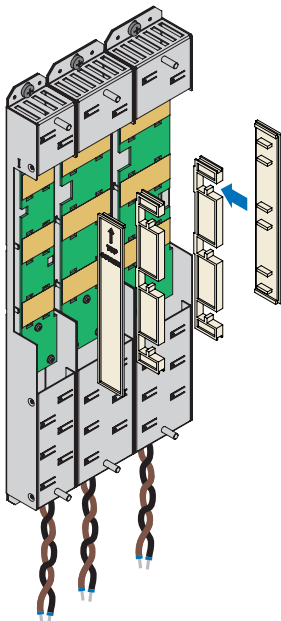

3. Shorten the copper rails to the correct length.
4. Clean the copper rails, especially at the contact points.

5. Insert the three copper rails one after the other.

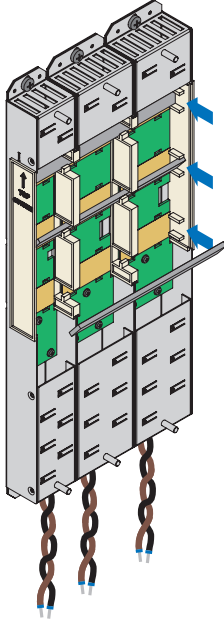

6. Fasten each of the copper rails with two quick fastening clamps per rail and Quick DC-Link module. Make certain the contact points of the copper rails do not become contaminated.

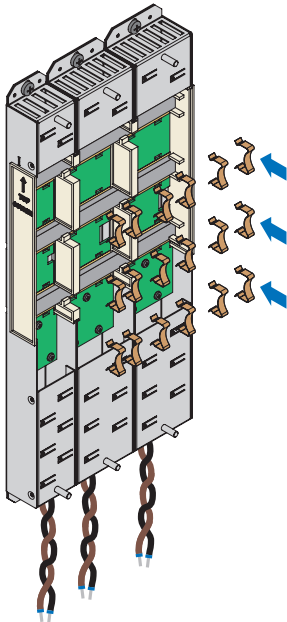

- ⇒ You have installed the Quick DC-Link. In the next step, build over the Quick DC-Link modules with the appropriate drive controllers.

10.7 Mounting the drive controller on the rear section module

WARNING!

Electrical voltage! Risk of fatal injury due to electric shock!

Hazardous voltages may be present on the connection terminals and the cores connected to them.

- Always switch off all power supply voltage before working on the devices!
- Note the discharge time of the DC link capacitors in the general technical data. You can only determine the absence of voltage after this time period.

Information

Note that drive controllers in storage require reforming each year or before commissioning at the latest.

Tools and material

You will need:

- A suitable terminal set for each drive controller
- An 8 mm hexagonal socket wrench to tighten the nut and washer assemblies on the threaded bolts

Requirements and installation

Perform the following steps for each drive controller within the group.

- ✓ There is a circuit diagram of the system that describes the connection of the drive controllers.
 - ✓ For each drive controller, the appropriate Quick DC-Link rear section modules for the DC link connection have already been installed in the installation position.
1. Remove terminal X22 from the appropriate terminal set. Connect the brown core D+ on the bottom of the Quick DC-Link module to D+ of terminal X22, and the black core D- of the Quick DC-Link module to D- of terminal X22. Make sure that the cores of the Quick DC-Link module are twisted pairs.

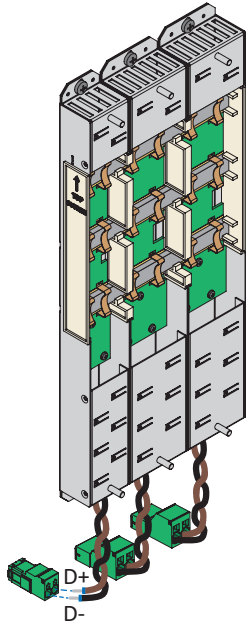

2. Place the drive controller on the bottom threaded bolt of the Quick DC-Link module and properly align it vertically with the bottom and top threaded bolt.

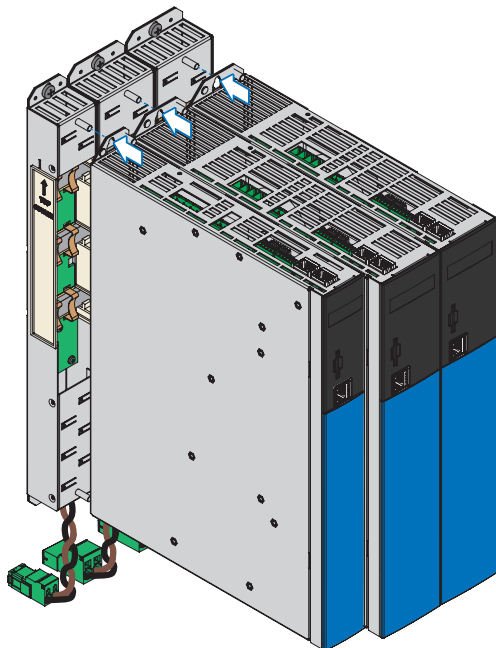

3. Fasten the drive controller to both threaded bolts of the Quick DC-Link module using the nut and washer assemblies (M5). The nut and washer assemblies are included with the Quick DC-Link module.

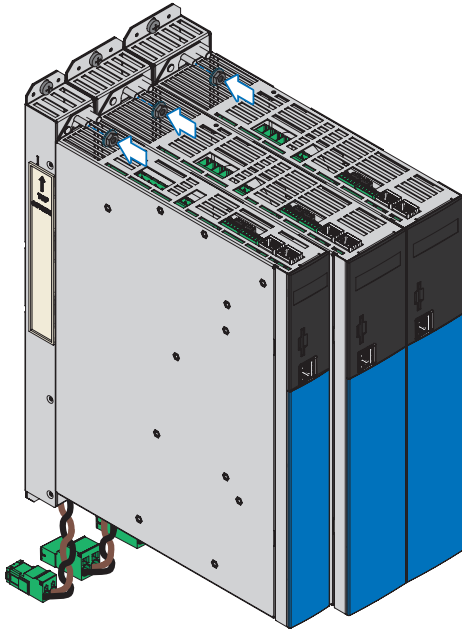

4. Connect the grounding conductor to the ground bolt. Obey the instructions and requirements for [Protective grounding](#) [▶ 101].
5. Attach the X22 terminal of the Quick DC-Link module.

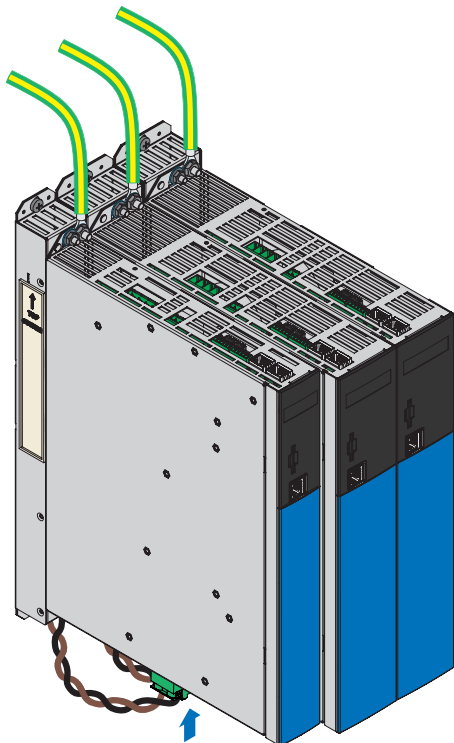

- ⇒ The installation is completed. In the next step, connect the drive controller.

11 Connection

The following chapter describes the connection of the drive controller and the available accessories.

11.1 Line routing

Observe the valid provisions for your machine or system, e.g. IEC 60364 or EN 50110, during the installation of electrical equipment.

11.2 Protective measures

Take the following protective measures into account.

11.2.1 Power supply with DC link connection

All drive controllers must be connected to the same supply grid.

ATTENTION!

Device damage due to the emission of electromagnetic interference!

If the EMC threshold limits are exceeded, devices in the immediate area can be interrupted or damaged.

- Take suitable measures to comply with the electromagnetic compatibility.
- Twist intermediate circuit connections and connections to braking resistors and always route the shortest possible connections. If they are longer than 30 cm, they must be shielded.

ATTENTION!

Device damage in the event of failure of a device in the DC link group!

The failure of a drive controller or supply module in the DC link group can result in damage to additional devices.

- A failure must trigger the isolation of the entire DC link group from the grid.
- For the most comprehensive equipment protection possible, follow the recommendations for device protection.

Wiring example

The example in the attachment (see [Wiring examples](#) [▶ 358]) illustrates the basic connection to Quick DC-Link DL6B based on a DC link connection.

11.2.2 Line fuse

All device types are intended exclusively for operation on TN networks or wye sources that supply a maximum differential short-circuit current in accordance with the following table.

For UL-compliant operation:

All device types supplied with 480 V_{AC} are intended solely for operation with grounded wye sources at 480/277 V_{AC}.

For all device types – with 240 V_{AC} or 480 V_{AC} supply – the supply grid must not deliver a differential short-circuit current above the specification in the following table.

Size of the drive controller	Max. differential short-circuit current
Size 0 – size 2	5000 A

Tab. 76: Short-circuit current rating (SCCR)

The line fuse ensures the line and overload protection in the drive controller. To that end, observe the requirements described below, which vary based on the configuration.

11.2.2.1 Line fuses in stand-alone operation

You can use the following protective devices when operating a single drive controller:

- Full-range safety fuses for cable and line protection with operating class gG in accordance with IEC 60269-2-1 or time delay triggering characteristics in accordance with DIN VDE 0636
- Miniature circuit breakers with triggering characteristic C in accordance with EN 60898
- Circuit breakers

Information on the recommended maximum line fuse can be found in the following table:

Size	Type	$I_{1N,PU}$ (4 kHz) [A]	Recommended max. line fuse [A]
0	SC6A062	10	10
1	SC6A162	23.2	25
2	SC6A261	22.6	25

Tab. 77: Line fuses in stand-alone operation

Information

To ensure problem-free operation, always comply with the recommended trigger limits and trigger characteristics of the fuse elements.

11.2.2.2 Line fuses for DC link connection

Every drive controller connected to the grid in the DC link group must be protected at the line input against overload and short-circuit. To do this, a fuse combination consisting of overload protection and semiconductor short-circuit protection is connected in series. A miniature circuit breaker protects against overload and a safety fuse with gR triggering characteristics protects against short-circuit.

Information

The installation of short-circuit fuses is not necessary under ideal requirements and ambient conditions. However, if the application conditions pose the risk of contaminating the drive controllers, short-circuit fuses can protect against damage to or failure of other devices within the DC link group.

You can use the following fuse combinations:

Size	Type	I _{1N,PU} (4 kHz) [A]	Fuse selection	
			Miniature circuit breakers	Safety fuse
0	SC6A062	10	EATON Type: FAZ-Z10/3, Item No.: 278926 Triggering characteristics: Z 10 A	SIBA Type: URZ, Item No. 50 140 06.25 Triggering characteristics: gR 25 A
1	SC6A162	23.2	EATON Type: FAZ-Z25/3, Item No.: 278929 Triggering characteristics: Z 25 A	SIBA Type: URZ, Item No. 50 140 06.50 Triggering characteristics: gR 50 A
2	SC6A261	22.6	EATON Type: FAZ-Z25/3, Item No.: 278929 Triggering characteristics: Z 25 A	SIBA Type: URZ, Item No. 50 140 06.50 Triggering characteristics: gR 50 A

Tab. 78: Line fuses for DC link connection

Information

To ensure problem-free operation, always comply with the recommended trigger limits and trigger characteristics of the fuse elements.

Maximum number of drive controllers

Two drive controllers of the same rating can be connected using a common fuse combination. The fuses and the resulting maximum line input current correspond to that of a single drive controller.

In order to prevent gradual damage to the safety fuse, you can operate a maximum of two drive controllers on one fuse combination.

ATTENTION!

Damage due to overload!

In order to ensure an even distribution of charging current on all AC-supplied drive controllers, all circuit breakers must be closed when engaging the power supply.

- In order that the input rectifier is not overloaded in the event of a possible fuse failure in the group, evaluation of the grid monitoring for AC-supplied drive controllers must lead to deactivation of the entire DC link group.

11.2.2.3 UL-compliant line fuses

For UL compliance, use one of the following protection measures:

- Class CC, CF, J, T, G or RK1 safety fuses
- Circuit breakers

More detailed specifications about the appropriate fuses can be found in the following table:

Size	Type	Safety fuse		Circuit breakers
		I_N [A]	U_N [V _{AC}]	
0	SC6A062	15	600	Recommendation: EATON FAZ-B10/3-NA Manufacturer No. 132723
				Alternative: EATON FAZ-B15/3-NA Manufacturer No. 132721
1	SC6A162	25	600	EATON FAZ-B25/3-NA Manufacturer No. 132726
1	SC6A261			

Tab. 79: UL-compliant line fuses

Information

To ensure problem-free operation, always comply with the recommended trigger limits and trigger characteristics of the fuse elements.

11.2.3 Grid connection for DC link connection

All drive controllers must be connected to the power grid simultaneously. Simultaneously in this case means that the time difference may be a maximum of 20 ms. This condition is generally met if you use contactors of identical design from one manufacturer.

Provided that simultaneous connection to the grid is achieved, the design with one contactor per drive controller is also permitted.

ATTENTION!

Damage due to overload!

If the grid does not connect to all drive controllers simultaneously in the design with one contactor per drive controller, their charging resistors can be damaged.

11.2.4 Residual current protective device

Depending on the function, leakage currents may occur when operating drive controllers. Leakage currents are interpreted as residual currents by residual current protective devices (RCDs) and may therefore lead to false triggering. Depending on the relevant power supply connections, residual currents may occur with or without a DC current component. Because of this, you should take into consideration both the magnitude as well as the profile of the possible leakage or residual current when selecting a suitable residual current protective device.

Leakage and residual currents with a DC current component can restrict the functionality of type A and AC residual current protective devices.

Protect 1-phase installations using type B universal current-sensitive residual current protective devices or type F mixed frequency-sensitive devices.

Protect 3-phase installations with type B universal current-sensitive residual current protective devices.

DANGER!

Electrical voltage! Risk of fatal injury due to electric shock!

In 3-phase installations, this product can cause a direct current in the protective grounding conductor.

- If a residual current protective device (RCD) or residual current monitoring device (RCM) is used for protection in case of direct or indirect contact, only one RCD or RCM of type B is permitted on the power supply side of this product.
-

False triggering – Causes

Depending on stray capacitances and imbalances, leakage currents above 30 mA may occur during operation.

Undesirable false triggering occurs under the following conditions:

- Connecting the installation to the supply voltage:
This false triggering can be remedied by using short-time delayed (super-resistant), delayed switch-off (selective) residual current protective devices or those with increased tripping current (e.g. 300 or 500 mA).
- Higher frequency leakage currents for long power cables under normal operating conditions:
For example, use low-capacitance cables or use an output choke.
- High imbalances in the supply grid.
This false triggering can be rectified, e.g. using an isolating transformer.

DANGER!

Electrical voltage! Risk of fatal injury due to electric shock!

Residual current protective devices with increased tripping current as well as with short-time delayed or delayed switch-off trigger characteristics may not meet the requirements for personal protection.

- Check whether the use of the selected residual current protective device is permitted in your application.
-

11.2.5 Protective grounding

In order to dimension the grounding, it must be ensured that the upstream fuse is triggered in the event of a short-circuit. Observe the requirements described below for the correct connection of the protective grounding.

11.2.5.1 Minimum cross-section of the grounding conductor

Leakage currents > 10 mA can arise in normal operation. The minimum cross-section of the protective grounding conductor must comply with the local safety regulations for protective grounding conductors with high leakage current. To fulfill regulations such as EN 60204-1, connect a copper conductor according to the following table:

Cross-section A Power grid line	Minimum cross-section A_{\min} Grounding conductor
$A \leq 2.5 \text{ mm}^2$	2.5 mm ²
$2.5 \text{ mm}^2 < A \leq 16 \text{ mm}^2$	A
$16 \text{ mm}^2 < A \leq 35 \text{ mm}^2$	$\geq 16 \text{ mm}^2$
$> 35 \text{ mm}^2$	A/2

Tab. 80: Minimum cross-section of the grounding conductor

11.2.5.2 Cable shields and sheaths

In accordance with EN 60204-1, the following parts of a machine and its electrical equipment must be connected to the grounding conductor system, but must not be used as grounding conductors:

- Metal cable shields
- Sheath

11.2.5.3 Connection of the grounding conductor

You connect the grounding conductor to the drive controller over terminal X10.

Additional requirements for protective equipotential bonding apply in the event of ground leakage currents > 10 mA. At least one of the following conditions must be fulfilled:

- The grounding conductor must have a minimum cross-section of 10 mm² Cu over its overall length
- If the grounding conductor has a cross-section of less than 10 mm², a 2nd grounding conductor must be provided with a cross-section of at least the same size, as at terminal X10, up to the point at which the grounding conductor exhibits the minimum cross-section of 10 mm²

A ground bolt is mounted to the devices for connecting the 2nd grounding conductor. The ground bolt is marked with the grounding symbol according to IEC 60417 (symbol 5019).

You will need an open-ended wrench or external hex key with a width across flats of 10 mm.

Obey a tightening torque of 4.0 Nm (35 Lb.inch).

Observe the order for assembly:

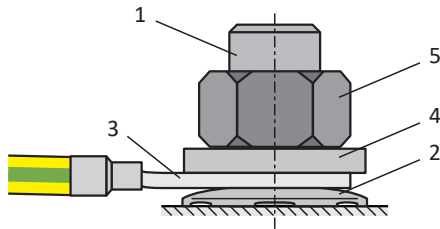

Fig. 26: Connection of the grounding conductor

- 1 M6 ground bolt
- 2 Contact disk
- 3 Cable lug
- 4 Washer
- 5 Nut

The contact disk, washer and nut are supplied with the drive controller.

11.2.5.4 UL-compliant connection of the grounding conductor

Note that UL-compliant operation requires just a single grounding conductor.

The grounding at terminal X10 of the SC6 drive controller must not be used for protective grounding. The housing for the drive controllers must be connected to the protective grounding using the M6 ground bolt (4.0 Nm, 35 Lb.inch).

The connection for the protective grounding on the housing is identified by the grounding symbol in accordance with IEC 60417 (symbol 5019).

You will need an open-ended wrench or external hex key with a width across flats of 10 mm.

Observe the order for assembly:

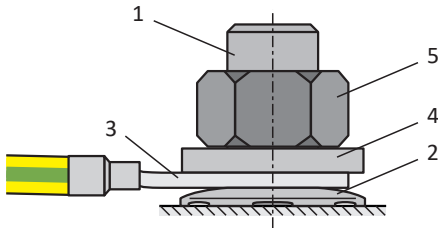

Fig. 27: Connection of the grounding conductor

- 1 M6 ground bolt
- 2 Contact disk
- 3 Cable lug
- 4 Washer
- 5 Nut

The contact disk, washer and nut are supplied with the drive controller.

11.2.6 EMC recommendations

Information

The following information on EMC-compliant installation is only a recommendation. Depending on the application, the ambient conditions as well as the legal requirements, measures beyond these recommendations may be required.

Lay the power line, power cable and signal lines separately from each other, e.g. in separate cable ducts.

Only use shielded, low-capacitance cables as power cables.

If the brake line is carried in the power cable, it must be shielded separately.

Ground and insulate free line ends if they cannot be connected to the terminals provided for this purpose on the drive controller, e.g. using a connecting terminal.

Connect the shield of the power cable to the grounding conductor system over a wide area and in the immediate vicinity of the drive controller. For this purpose, use the shield contact provided for the drive controllers or suitable accessories.

The connection lines for braking resistors as well as the cores of the Quick DC-Link modules must be implemented as twisted pairs. At line lengths of 30 cm or more, the lines also must be implemented with shielding and the shield must be applied over a wide area in the immediate vicinity of the drive controller.

For motors with terminal boxes, connect the shield to the terminal box over large contact areas. For example, use EMC cable glands.

Connect the shield of the control lines on one side to the reference potential of the source, e.g. the PLC or CNC.

You may use chokes to improve the EMC and protect the drive system. Output chokes reduce current peaks caused by line capacity at the power output of the drive controller.

ATTENTION!

Material damage due to incorrect or uncontrolled movement!

When connecting Lean motors in combination with an output choke, a successful position and speed determination is not ensured. This can lead to an incorrect or uncontrolled movement right from the start.

- If Lean motors are connected, output chokes must not be used.

11.3 Drive controllers

The following section contains detailed information about the terminals and the correct connection of the drive controller.

Information

For UL-compliant operation: The connections marked with PE are intended solely for the functional grounding.

11.3.1 Overview

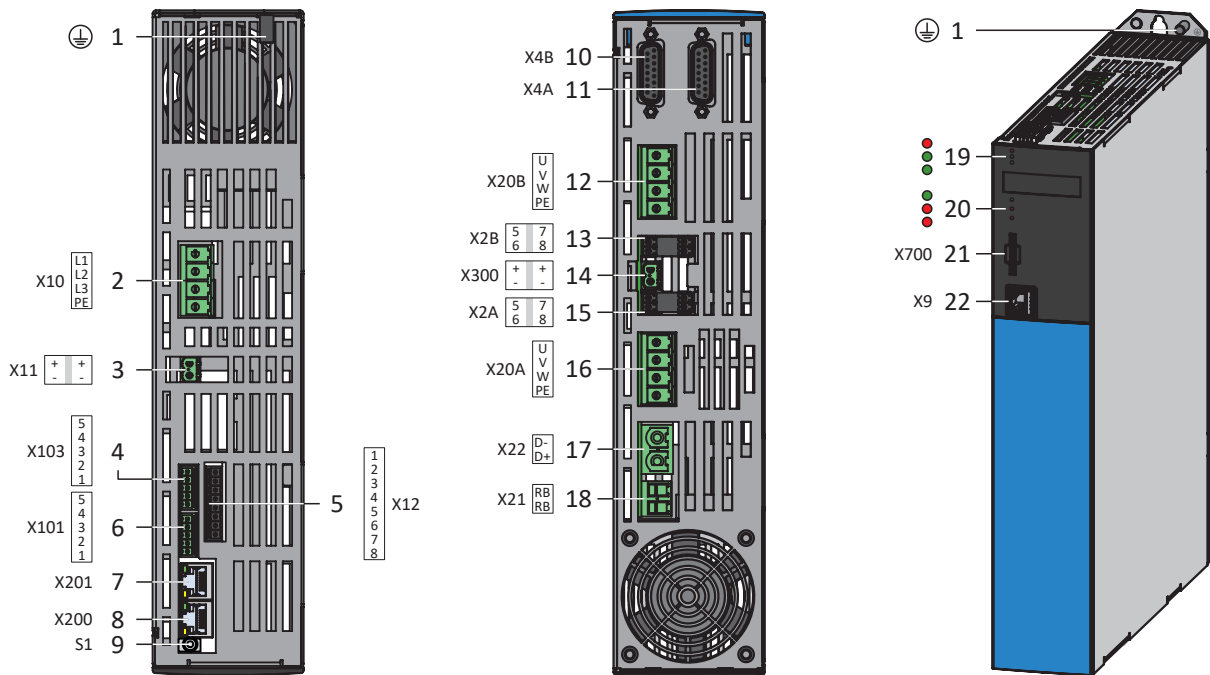

Fig. 28: Connection overview using the example of the SC6A162

Top of the device		Bottom of the device		Front of the device	
1	Ground bolt	10	X4B: Encoder B	19	3 diagnostic LEDs for communication and safety technology
2	X10: 400 V _{AC} supply	11	X4A: Encoder A	20	3 diagnostic LEDs for drive controller
3	X11: 24 V _{DC} supply	12	X20B: Motor B	21	X700: SD slot
4	X103: DI6 – DI9	13	X2B: Brake or DO (pin 5/6) and temperature sensor B (pin 7/8)	22	X9: Ethernet service interface
5	X12: STO via terminals (only for SR6 option)	14	X300: 24 V _{DC} supply for brakes		
6	X101: DI1 – DI4	15	X2A: Brake or DO (pin 5/6) and temperature sensor A (pin 7/8)		
7	X201: EtherCAT Out / PROFINET	16	X20A: Motor A		
8	X200: EtherCAT In / PROFINET	17	X22: DC link connection		
9	S1 operating button	18	X21: Braking resistor		

11.3.2 X2A: Brake or digital output

All device types of the SC6 drive controller can control 24 V_{DC} brakes as standard.

Without the SX6 safety module, the brake of axis A is connected to X2A. Alternatively, you can use X2A as a digital output (see [Brake connection as digital output \[▶ 221\]](#)).

Information	
--------------------	--

You can deactivate brake monitoring for cable breaks and undervoltage in parameter F105.

With the SX6 safety module, brake 1 and brake 2 must be assigned to terminals X2A and X2B in PASmotion Safety Configurator via the Safe Brake Control 2-pole (SBC) safety function.

Information	
--------------------	--

If you want to use the extended safety technology using FSoE, be sure to read the manual for the SX6 safety module.

Technical data

Note the technical data of the brakes controllable at X2 (see [Controllable brakes \[▶ 64\]](#)).

Connection

	Pin	Designation	Role
 5 6	5	1BD1	Without SX6: Brake control or use as digital output
		SBC+	With SX6: Output for brake control + (SBC 2-pole)
	6	1BD2	Without SX6: Reference potential
		SBC-	With SX6: Output for brake control - (SBC 2-pole)

Tab. 81: X2 connection description, brake or digital output

For the connecting wiring, obey the terminal specification [BCF 3,81 180 SN \[▶ 353\]](#).

Feature	Use	All sizes
Max. core/cable length	Direct brake control	100 m, shielded
	Indirect brake control or digital output	3 m

Tab. 82: Maximum core/cable length [m]

11.3.3 X2A: Motor temperature sensor A

The motor temperature sensor of axis A is connected to terminal X2A. All device types of the SC6 drive controller have connections for PTC thermistors.

Information

Evaluation of the temperature sensor is always active. If operation without a temperature sensor is permitted, the connections must be bridged to X2. Otherwise a fault is triggered when the device is switched on.

Information

Note that a temperature sensor does not have to be connected to terminal X2 for EnDat 3 or HIPERFACE DSL encoders. In this case, the temperature sensor signal is transferred together with the encoder signal over connector X4.

	Pin	Designation	Role
 7 8	7	1TP1	PTC connection
	8	1TP2	

Tab. 83: X2 connection description, motor temperature sensor

For the connecting wiring, obey the terminal specification [BCF 3,81 180 SN \[▶ 353\]](#).

Feature	All sizes
Max. cable length	100 m, shielded

Tab. 84: Maximum cable length [m]

11.3.4 X2B: Brake or digital output

Without the SX6 safety module, the brake of axis B is connected to X2B. Alternatively, you can use X2B as a digital output (see [Brake connection as digital output \[▶ 221\]](#)).

With the SX6 safety module, brake 1 and brake 2 must be assigned to terminals X2A and X2B in PASmotion Safety Configurator via the Safe Brake Control 2-pole (SBC) safety function.

The connection description of X2B matches the X2A description.

11.3.5 X2B: Motor temperature sensor B

The motor temperature sensor of axis B is connected to X2B for double-axis controllers. Only X2A is available for single-axis controllers. The connection description of X2B matches the X2A description.

11.3.6 X4A: Encoder A

The encoder of axis A is connected to terminal X4A.

ATTENTION!

Risk of encoder destruction!

Only encoders with a suitable input voltage range (minimum 12 V_{DC}) may be connected to X4.

Unsuitable encoder models

The following encoder models must **not** be connected due to their supply voltage:

Encoder model	Code according to type designation
ECI 1118	C0, C2
EQI 1130	Q0, Q2
ECI 1319	CR
EQI 1329	QP
EQI 1331	QR

Tab. 85: Encoder models with unsuitable supply voltage range

ATTENTION!

Risk of encoder destruction!

X4 may not be plugged in or unplugged when the device is switched on!

Technical data

Note the technical data of the evaluable encoders at X4 (see [Evaluable encoders \[▶ 58\]](#)).

Connection

EnDat 2.1/2.2 digital encoders and SSI encoders

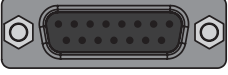
Bush	Pin	Designation	Role
8 7 6 5 4 3 2 1	1	—	—
	2	0 V GND	Reference potential for encoder supply to pin 4
	3	—	—
	4	U ₂	Encoder supply
	5	Data +	Differential input for DATA
	6	—	—
	7	—	—
	8	Clock +	Differential input for CLOCK
	9	—	—
	10	—	—
	11	—	—
	12	—	—
	13	Data -	Inverse differential input for DATA
	14	—	—
	15	Clock -	Inverse differential input for CLOCK

Tab. 86: X4 connection description for EnDat 2.1/2.2 digital encoders and SSI encoders

Differential TTL and differential HTL incremental encoders (HTL via HT6 adapter)

Information

Using an HT6 adapter for level conversion from HTL signals to TTL signals, it is also possible to connect a differential HTL incremental encoder to terminal X4. Note that, with an external power supply, the maximum level of 20 V_{DC} for the HTL signals may not be exceeded.

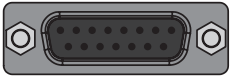
Bush	Pin	Designation	Role
8 7 6 5 4 3 2 1	1	—	—
	2	0 V GND	Reference potential for encoder supply to pin 4
	3	—	—
15 14 13 12 11 10 9	4	U ₂	Encoder supply
	5	B +	Differential input for B track
	6	—	—
	7	N +	Differential input for N track
	8	A +	Differential input for A track
	9	—	—
	10	—	—
	11	—	—
	12	—	—
	13	B -	Inverse differential input for B track
	14	N -	Inverse differential input for N track
	15	A -	Inverse differential input for A track

Tab. 87: X4 connection description for differential TTL and differential HTL incremental encoders (HTL via HT6 adapter)

Resolvers

Information

For connecting con.23 resolver cables with a 9-pin D-sub connector, such as the standard design for ED/EK synchronous servo motors, you must use interface adapter AP6A00 (ID No. 56498) or AP6A01 (ID No. 56522, with motor temperature sensor leads), available separately.

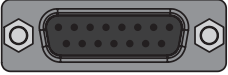
Bush	Pin	Designation	Role
<div style="display: flex; justify-content: space-between;"> 8 7 6 5 4 3 2 1 </div>  <div style="display: flex; justify-content: space-between;"> 15 14 13 12 11 10 9 </div>	1	S4 Sin +	Sin input
	2	R1 Ref –	Reference potential for pin 6
	3	S3 Cos +	Cos input
	4	—	—
	5	—	—
	6	R2 Ref +	Resolver excitation signal
	7	—	—
	8	—	—
	9	S2 Sin –	Reference potential for pin 1
	10	—	—
	11	S1 Cos –	Reference potential for pin 3
	12	—	—
	13	—	—
	14	—	—
	15	—	—

Tab. 88: X4 connection description for resolvers

EnDat 3 and HIPERFACE DSL encoders

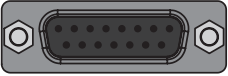
Bush	Pin	Designation	Role
	1	—	—
	2	P_D -	Inverse EnDat 3 or HIPERFACE DSL signal (motor temperature sensor evaluation over EnDat or DSL communication)
	3	—	—
	4	P_D +	EnDat 3 or HIPERFACE DSL signal (motor temperature sensor evaluation over EnDat or DSL communication)
	5	—	—
	6	—	—
	7	—	—
	8	—	—
	9	—	—
	10	—	—
	11	—	—
	12	—	—
	13	—	—
	14	—	—
	15	—	—

Tab. 89: X4 connection description for EnDat 3 and HIPERFACE DSL encoders

Cable requirements

Feature	All sizes
Max. cable length	100 m, shielded

Tab. 90: Maximum cable length [m]

Information
<p>To ensure proper functionality, we recommend using cables from STOBER that are matched to the complete system. If unsuitable cables are used, we reserve the right to reject claims under the warranty.</p>

11.3.6.1 HT6 interface adapter (HTL to TTL)

HT6 – HTL to TTL (15-pin to 15-pin)

Interface adapter for level conversion from HTL signals to TTL signals for connecting the encoder cable to the drive controller.

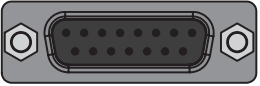
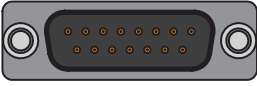
Socket ⁹	Pin	Designation	Function	Pin	Connector ¹⁰
 8 7 6 5 4 3 2 1 15 14 13 12 11 10 9	1	B +	Differential input for B track	5	 1 2 3 4 5 6 7 8 9 10 11 12 13 14 15
	2	0 V GND	Reference potential for encoder supply to pin 4	2	
	3	N +	Differential input for N track	7	
	4	U ₂	Encoder supply	4	
	5	—	—	—	
	6	A +	Differential input for A track	8	
	7	—	—	—	
	8	—	—	—	
	9	B -	Inverse differential input for B track	13	
	10	N -	Inverse differential input for N track	14	
	11	A -	Inverse differential input for A track	15	
	12	—	—	—	
	13	—	—	—	
	14	—	—	—	
	15	—	—	—	

Tab. 91: HT6 connection description for HTL differential encoder (15-pin to 15-pin)

⁹View of 15-pin D-sub for connecting the encoder cable

¹⁰View of 15-pin D-sub for connecting to terminal X4

11.3.6.2 AP6 interface adapter (resolver)

AP6A00 – Resolver (9-pin to 15-pin)

Interface adapter for connecting the resolver cable with 9-pin D-sub connector to the drive controller.

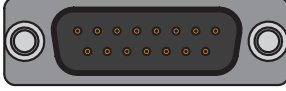
Socket ¹¹	Pin	Designation	Function	Pin	Connector ¹²
	1	—	—	—	
	2	1TP1	—	—	
	3	S2 Sin –	Reference potential for sin input	9	
	4	S1 Cos –	Reference potential for cos input	11	
	5	R1 Ref –	Reference potential for resolver excitation signal	2	
	6	1TP2	—	—	
	7	S4 Sin +	Sin input	1	
	8	S3 Cos +	Cos input	3	
	9	R2 Ref +	Resolver excitation signal	6	

Tab. 92: AP6A00 connection description for resolver (9-pin to 15-pin)

¹¹View of 9-pin D-sub for connecting the SDS 4000-compatible resolver cable

¹²View of 15-pin D-sub for connecting to terminal X4

AP6A01 – Resolver and motor temperature sensor (9-pin to 15-pin)

Interface adapter with temperature sensor cores led out at the side (core length: approx. 11 cm) for connecting the resolver cable with 9-pin D-sub connector to the drive controller.

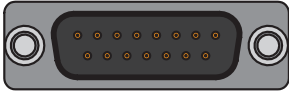
Socket ¹³	Pin	Designation	Function	Pin	Connector ¹⁴
 1 2 3 4 5 6 7 8 9	1	—	—	—	 1 2 3 4 5 6 7 8 9 10 11 12 13 14 15
	2	1TP1	Motor temperature sensor connection, if included in the encoder cable connector; routed out for the direct connection to terminal X2	—	
	3	S2 Sin –	Reference potential for sin input	9	
	4	S1 Cos –	Reference potential for cos input	11	
	5	R1 Ref –	Reference potential for resolver excitation signal	2	
	6	1TP2	Motor temperature sensor connection, if included in the encoder cable connector; routed out for the direct connection to terminal X2	—	
	7	S4 Sin +	Sin input	1	
	8	S3 Cos +	Cos input	3	
	9	R2 Ref +	Resolver excitation signal	6	

Tab. 93: AP6A01 connection description for the resolver and motor temperature sensor (9-pin to 15-pin)

11.3.7 X4B: Encoder B

The encoder of axis B is connected to X4B for double-axis controllers. Only X4A is available for single-axis controllers. The connection description of X4B matches the X4A description.

Information

Note that a master encoder must be connected to axis A during synchronous operation.

¹³View of 9-pin D-sub for connecting the SDS 4000-compatible resolver cable

¹⁴View of 15-pin D-sub for connecting to terminal X4

11.3.8 X9: Ethernet service interface

X9 is used to connect the drive controller to a PC with DriveControlSuite commissioning software installed.

Connection

Socket	Pin	Designation	Function
1 2 3 4 5 6 7 8 	1	TxData+	Ethernet communication
	2	TxData-	
	3	RecvData+	
	4	-	-
	5	-	-
	6	RecvData-	Ethernet communication
	7	-	-
	8	-	-

Tab. 94: X9 connection description

Cable requirements

Feature	All sizes
Max. cable length	100 m, shielded

Tab. 95: Maximum cable length [m]

Information	<p>To ensure proper functionality, we recommend using cables from STOBER that are matched to the complete system. If unsuitable cables are used, we reserve the right to reject claims under the warranty.</p>
--------------------	--

It is also possible to use cables with the following specification:

Feature	Design
Connector wiring	Patch or crossover
Quality	CAT 5e
Shielding	SF/FTP, S/FTP or SF/UTP

Tab. 96: Cable requirements

Device addressing

For information on device addressing, see [Device addressing](#) [▶ 365].

11.3.9 X10: 400 V supply

Terminal X10 serves to connect the drive controller to the supply grid.

Conductor cross-sections for the power connection

When selecting the conductor cross-section, note the line fuse, the maximum permitted conductor cross-section of terminal X10, the routing method and the surrounding temperature.

UL-compliant operation

The grounding at terminal X10 of the SC6 drive controller must not be used for protective grounding. The housing for the drive controllers must be connected to the protective grounding using the M6 ground bolt (4.0 Nm, 35 Lb.inch).

Connection

Size 0

Terminal	Pin	Designation	Role
 1 2 3 4	1	L1	Power supply
	2	L2	
	3	L3	
	4	PE	Grounding conductor

Tab. 97: X10 connection description, size 0

For the connecting wiring, obey the terminal specification [GFKC 2,5 -ST-7,62 \[▶ 355\]](#).

Sizes 1 and 2

Terminal	Pin	Designation	Role
 1 2 3 4	1	L1	Power supply
	2	L2	
	3	L3	
	4	PE	Grounding conductor

Tab. 98: X10 connection description, sizes 1 and 2

For the connecting wiring, obey the terminal specification [SPC 5 -ST-7,62 \[▶ 357\]](#).

11.3.10 X11: 24 V supply – Control unit

The connection of 24 V_{DC} to X11 is required for the power supply of the control unit.

ATTENTION!

Device damage due to overload!

If the 24 V_{DC} power supply is looped to multiple devices over the terminal, the terminal may be damaged by a current that is too high.

- Make sure that the current over the terminal does not exceed the value 15 A (UL: 10 A).

Technical data

Electrical data	All types
U _{1CU}	24 V _{DC} +20%/–15%
I _{1maxCU}	1.5 A

Tab. 99: Control unit electrical data

Connection

Information

The device may not be connected to a DC supply grid. Instead, supply it over a local 24 V_{DC} power supply unit.

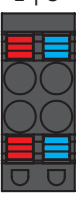
	Pin	Designation	Role
	1	+	24 V _{DC} supply for the control unit; bridged in the terminal; design in accordance with EN 60204: PELV, secondary grounded, recommended fuse protection: max. 15 AT ¹⁵
	2		
	3	–	Reference potential for +24 V _{DC} , bridged in the terminal
	4		

Tab. 100: X11 connection description

For the connecting wiring, obey the terminal specification [BLDF 5.08 180 SN \[▶ 353\]](#).

Feature	All sizes
Max. core/cable length	30 m

Tab. 101: Maximum core/cable length [m]

¹⁵ For UL-compliance, use a 10 A fuse (time delay). Make sure that the fuse meets certification requirements for DC voltage in accordance with UL 248.

11.3.11 X12 (SR6 option): Safety technology

The SR6 option adds the STO safety function to the SC6 drive controller via terminal X12.

For double-axis controllers, the STO safety function has a two-channel structure that acts upon both axes.

Information

If you would like to use the STO safety function via terminals, be sure to read the manual for the SR6 safety module.

If you do not want to use the safety function, connect STO_a and STO_b to 24 V_{DC} and connect GND to the reference potential, e.g., using a connection with terminal X11.

Technical data

Obey the technical data of the safety options at X12 (see [SR6 safety module](#) [► 56]).

Connection

Terminal	Pin	Designation	Role
 1 2 3 4 5 6 7 8	1	STO_a	Input of safety channel 1
	2		
	3	STO_b	Input of safety channel 2
	4		
	5	0 V GND	Reference potential for STO_a and STO_b , internally bridged with pin 7
	6	STO_{status}	Feedback signal of safety channels 1 and 2 for diagnostic purposes
	7	0 V GND	Reference potential for STO_a and STO_b , internally bridged with pin 5
	8	$U_{1status}$	STO_{status} supply; recommended fuse protection: max. 3.15 A ^{T16}

Tab. 102: X12 connection description

For the connecting wiring, obey the terminal specification [BCF 3,81 180 SN](#) [► 353].

Feature	All sizes
Max. core/cable length	30 m

Tab. 103: Maximum core/cable length [m]

¹⁶ For UL-compliance, use a 3.15 A fuse (time delay). The fuse must be certified for DC voltage in accordance with UL 248.

11.3.12 X20A: Motor A

The motor of axis A is connected to X20A.

UL-compliant operation

The protective grounding of motors connected to the drive controller must not be connected using terminals X20A and X20B. The grounding conductor connection of the motor must be ensured for the respective application in accordance with the valid electrical standards.

For the protective grounding of the motor, use the grounding conductor connection available on the motor.

Connection

Size 0

Terminal	Pin	Designation	Role
 1 2 3 4	1	U	Motor phase U connection
	2	V	Motor phase V connection
	3	W	Motor phase W connection
	4	PE	Grounding conductor

Tab. 104: X20 connection description, size 0

For the connecting wiring, obey the terminal specification [GFKC 2,5 -ST-7,62 \[▶ 355\]](#).

Sizes 1 and 2

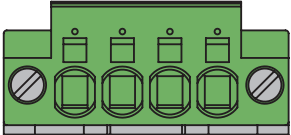
Terminal	Pin	Designation	Role
 1 2 3 4	1	U	Motor phase U connection
	2	V	Motor phase V connection
	3	W	Motor phase W connection
	4	PE	Grounding conductor

Tab. 105: X20 connection description, sizes 1 and 2

For the connecting wiring, obey the terminal specification [SPC 5 -ST-7,62 \[▶ 357\]](#).

Cable requirements

Motor type	Connection	Size 0 to 2
Synchronous servo motor, asynchronous motor	Without output choke	50 m, shielded
Synchronous servo motor, asynchronous motor	With output choke	100 m, shielded
Lean motor	Without output choke	50 m, shielded ^{a)}

Tab. 106: Maximum cable length of the power cable [m]

The use of cables with a length greater than 50 m and up to maximum 100 m must be checked by STOBER for the application.

Information

To ensure proper functionality, we recommend using cables from STOBER that are matched to the complete system. If unsuitable cables are used, we reserve the right to reject claims under the warranty.

Shielded connection of the power cable

Note the following points for the connection of the power cable:

- Ground the shield of the power cable on the shield contact on the drive controller intended for this.
- Keep the exposed conductors as short as possible. All devices and circuits that are sensitive to EMC must be kept at a distance of at least 0.3 m.

11.3.13 X20B: Motor B

The motor of axis B is connected to X20B for double-axis controllers. Only X20A is available for single-axis controllers. The connection description of X20B matches the X20A description.

11.3.14 X21: Braking resistor

Terminal X21 is available for the connection of a braking resistor.

Connection

Size 0

Terminal	Pin	Designation	Role
 <p>1 2</p>	1	RB	Braking resistor connection
	2	RB	

Tab. 107: X21 connection description, size 0

For the connecting wiring, obey the terminal specification [GFKIC 2.5 -ST-7.62 \[▶ 355\]](#).

Sizes 1 and 2

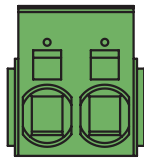
Terminal	Pin	Designation	Role
 <p>1 2</p>	1	RB	Braking resistor connection
	2	RB	

Tab. 108: X21 connection description, sizes 1 and 2

For the connecting wiring, obey the terminal specification [ISPC 5 -STGCL-7,62 \[▶ 356\]](#).

Feature	All sizes
Max. core/cable length	3 m, > 30 cm shielded

Tab. 109: Maximum core/cable length [m]

11.3.15 X22: DC link connection

Terminal X22 is available for the DC link connection of the drive controller.

Project configuration

For setting up the Quick DC-Link, obey the information on project configuration (see [DC link connection](#) [▶ 71]).

Connection

Size 0

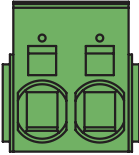
Terminal	Pin	Designation	Role
 1 2	1	D-	DC link connection
	2	D+	

Tab. 110: X22 connection description, size 0

For the connecting wiring, obey the terminal specification [ISPC 5 -STGCL-7,62](#) [▶ 356].

Sizes 1 and 2

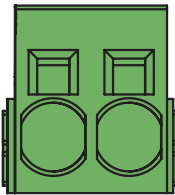
Terminal	Pin	Designation	Role
 1 2	1	D-	DC link connection
	2	D+	

Tab. 111: X22 connection description, sizes 1 and 2

For the connecting wiring, obey the terminal specification [ISPC 16 -ST-10,16](#) [▶ 356].

Feature	All sizes
Max. core/cable length	3 m, > 30 cm shielded

Tab. 112: Maximum core/cable length [m]

Wiring example

The example in the attachment (see [Wiring examples](#) [▶ 358]) illustrates the basic connection to Quick DC-Link DL6B based on a DC link connection.

11.3.16 X101: DI1 – DI4

Digital inputs 1 to 4 are available at terminal X101.

X101 for digital signals

For evaluating digital signals at X101, obey the specification for the digital inputs in the technical data of the drive controller (see [X101, X103: Digital inputs](#) [▶ 45]).

Connection

Terminal	Pin	Designation	Role
 5 4 3 2 1	1	DI1	Digital inputs
	2	DI2	
	3	DI3	
	4	DI4	
	5	0 V DGND	Reference potential; not bridged with X103, pin 5

Tab. 113: X101 connection description for digital signals

For the connecting wiring, obey the terminal specification [FMC 1,5 -ST-3,5](#) [▶ 354].

Feature	All sizes
Max. core/cable length	30 m

Tab. 114: Maximum core/cable length [m]

X101 for encoders

If you would like to use X101 as an encoder connection, obey the technical data of the evaluable encoders at X101 (see [X101: Encoder](#) [▶ 63]).

Connection

Single-ended HTL incremental encoders

Terminal	Pin	Designation	Role
 5 4 3 2 1	1	DI1	—
	2	DI2	N track
	3	DI3	A track
	4	DI4	B track
	5	0 V DGND	Reference potential; not bridged with X103, pin 5

Tab. 115: X101 connection description for single-ended HTL incremental signals, axis A

Single-ended HTL pulse/direction interface

Terminal	Pin	Designation	Role
 5 4 3 2 1	1	DI1	—
	2	DI2	—
	3	DI3	Frequency
	4	DI4	Direction
	5	0 V DGND	Reference potential; not bridged with X103, pin 5

Tab. 116: X101 connection description for single-ended HTL pulse/direction signals, axis A

Single-ended HTL Hall sensor

Terminal	Pin	Designation	Role
 5 4 3 2 1	1	DI1	Hall A
	2	DI2	Hall B
	3	DI3	Hall C
	4	DI4	—
	5	0 V DGND	Reference potential; not bridged with X103, pin 5

Tab. 117: X101 connection description for single-ended HTL Hall sensor signals, axis A

For the connecting wiring, obey the terminal specification [FMC 1,5 -ST-3,5](#) [▶ 354].

Feature	All sizes
Max. core/cable length	30 m

Tab. 118: Maximum core/cable length [m]

11.3.17 X103: DI6 – DI9

Digital inputs 6 to 9 are available at terminal X103.

X103 for digital signals

For the evaluation of digital signals at X103, obey the technical data of the drive controller (see [X101, X103: Digital inputs \[▶ 45\]](#)).

Connection

Terminal	Pin	Designation	Role
 5 4 3 2 1	1	DI6	Digital inputs
	2	DI7	
	3	DI8	
	4	DI9	
	5	0 V DGND	Reference potential; not bridged with X101, pin 5

Tab. 119: X103 connection description for digital signals

For the connecting wiring, obey the terminal specification [FMC 1,5 -ST-3,5 \[▶ 354\]](#).

Feature	All sizes
Max. core/cable length	30 m

Tab. 120: Maximum core/cable length [m]

X103 for encoders

If you would like to use X103 as an encoder connection, obey the technical data of the evaluable encoders at X103 (see [X103: Encoder \[▶ 63\]](#)).

Connection

Information

Note that a master encoder must be connected to X101 during synchronous operation.

Single-ended HTL incremental encoders

Terminal	Pin	Designation	Role
 5 4 3 2 1	1	DI6	—
	2	DI7	N track
	3	DI8	A track
	4	DI9	B track
	5	0 V DGND	Reference potential; not bridged with X101, pin 5

Tab. 121: X103 connection description for single-ended HTL incremental signals, axis B

Single-ended HTL pulse/direction interface

Terminal	Pin	Designation	Role
 5 4 3 2 1	1	DI6	—
	2	DI7	—
	3	DI8	Frequency
	4	DI9	Direction
	5	0 V DGND	Reference potential; not bridged with X101, pin 5

Tab. 122: X103 connection description for single-ended HTL pulse/direction signals, axis B

Single-ended HTL Hall sensor

Terminal	Pin	Designation	Role
 5 4 3 2 1	1	DI6	Hall A
	2	DI7	Hall B
	3	DI8	Hall C
	4	DI9	—
	5	0 V DGND	Reference potential; not bridged with X101, pin 5

Tab. 123: X103 connection description for single-ended HTL Hall sensor signals, axis B

For the connecting wiring, obey the terminal specification [FMC 1,5 -ST-3,5](#) [▶ 354].

Feature	All sizes
Max. core/cable length	30 m

Tab. 124: Maximum core/cable length [m]

11.3.18 X200, X201: EtherCAT

The drive controllers have both RJ-45 sockets X200 and X201. The sockets are located on top of the device. The associated pin assignment and color coding correspond to the EIA/TIA-T568B standard.

Connection

Connect X200 as an input to the cable coming from the EtherCAT MainDevice. Connect X201 as an output to any subsequent EtherCAT nodes.

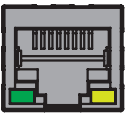
Socket	Pin	Designation	Function
1 2 ... 7 8 	1	Tx+	Communication
	2	Tx-	
	3	Rx+	
	4	—	—
	5	—	—
	6	Rx-	Communication
	7	—	—
	8	—	—

Tab. 125: X200 and X201 connection description

Cable requirements

Information

To ensure proper functionality, we recommend using cables from STOBER that are matched to the complete system. If unsuitable cables are used, we reserve the right to reject claims under the warranty.

STOBER provides ready-made cables for EtherCAT connection. It is also possible to use cables with the following specification:

Ethernet patch cables or crossover cables meeting the CAT 5e quality level are the ideal cables. The Fast Ethernet technology allows a maximum cable length of 100 m between two nodes.

Information

Ensure that you only use shielded cables with an SF/FTP, S/FTP or SF/UTP design.

Device addressing and fieldbus connection

For information on device addressing, see [Device addressing \[▶ 365\]](#).

You will find detailed information about the fieldbus connection in the corresponding manual for communication with EtherCAT.

11.3.19 X200, X201: PROFINET

In order to be able to connect the drive controllers to other PROFINET nodes, an integrated switch with both X200 and X201 RJ-45 sockets is provided. The sockets are located on top of the device. The associated pin assignment and color coding correspond to the EIA/TIA-T568B standard.

Connection

Connect X200 or X201 with the IO controller and the remaining connection with the next drive controller.

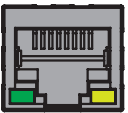
Socket	Pin	Designation	Function
1 2 ... 7 8 	1	Tx+	Communication
	2	Tx-	
	3	Rx+	
	4	—	—
	5	—	—
	6	Rx-	Communication
	7	—	—
	8	—	—

Tab. 126: X200 and X201 connection description

Cable requirements

The connections between the nodes of a PROFINET network generally consist of symmetrical, shielded copper cables twisted in pairs (shielded twisted pair, CAT 5e quality level). Fiber-optic cables are also a possible means of transmission.

Signals are transmitted according to the 100BASE TX method, i.e. with a transfer rate of 100 Mbps at a frequency of 125 MHz. A maximum of 1440 bytes can be transferred per frame. The maximum cable length is 100 m.

PROFINET cables exist in different versions that are tailored to different application scenarios and ambient conditions.

We recommend using the cables and plug connectors specified in the PROFINET installation guidelines. They are adjusted for use in automation technology with regard to usage, resistance, EMC properties and color coding.

There are type A, B and C cables, differentiated by installation type:

- Type A
4-wire shielded copper cable for fixed installation
- Type B
4-wire shielded copper cable for flexible installation
- Type C
4-wire shielded copper cable for constant movements

Device addressing and fieldbus connection

For information on device addressing, see [Device addressing \[▶ 365\]](#).

Detailed information about the fieldbus connection can be found in the corresponding manual for communication with PROFINET.

11.3.20 X300: 24 V supply – Brakes or digital outputs

X300 is used to supply the brakes and digital outputs.

ATTENTION!

Device damage due to overload!

If the 24 V_{DC} power supply is looped to multiple devices over the terminal, the terminal may be damaged by a current that is too high.

- Make sure that the current over the terminal does not exceed the value 15 A (UL: 10 A).

Technical data

Electrical data	Single-axis controller	Double-axis controller
U ₁	+24 V _{DC} +20%	
I _{1max}	5 A	5 A

Tab. 127: X300 electrical data – Supply of brakes and digital outputs

Connection

	Pin	Designation	Role
	1	+	24 V _{DC} supply for the brakes or outputs, bridged in the terminal; design in accordance with EN 60204-1: PELV, secondary grounded, recommended fuse protection: max. 15 A ¹⁷
	2		
	3	-	Reference potential for supply voltage
	4		

Tab. 128: X300 connection description

For the connecting wiring, obey the terminal specification [BLDF 5.08 180 SN \[▶ 353\]](#).

Feature	All sizes
Max. core/cable length	30 m

Tab. 129: Maximum core/cable length [m]

¹⁷ For UL-compliance, use a 10 A fuse (time delay). Make sure that the fuse meets certification requirements for DC voltage in accordance with UL 248.

11.3.21 X700: SD slot

The SD slot is used for data backup in case of service. SD and SDHC cards with storage capacity from 128 MB to 32 GB are supported. SDHC cards with a storage capacity of 64 GB can be used only if they have been first reformatted to max. 32 GB (FAT32). Since higher capacities extend the controller start-up time, STOBER recommends the use of cards with a storage capacity of 2 to 4 GB.

Information

The drive controller has internal configuration memory and can therefore be operated without an inserted SD card. In the DriveControlSuite commissioning software, the action Save values always saves to both the internal configuration memory and the inserted SD card. Back up your configuration to an SD card after completing commissioning in order to allow transfer of the configuration to the replacement drive controller in case of service. When the replacement drive controller is switched on, the data is loaded with priority given to the inserted SD card. To make a non-volatile back-up in the internal configuration memory, you must perform the Save values action in parameter A00 or press and hold the S1 operating button on the drive controller for 3 s.

11.3.22 Connecting a drive controller

WARNING!

Electrical voltage! Risk of fatal injury due to electric shock!

Hazardous voltages may be present on the connection terminals and the cores connected to them.

- Always switch off all power supply voltage before working on the devices!
- Note the discharge time of the DC link capacitors in the general technical data. You can only determine the absence of voltage after this time period.

Tools and material

You will need:

- A suitable terminal set for the drive controller
- Tool for tightening the fastening screws

Requirements and connection

Bottom of the device:

- ✓ You have a system circuit diagram describing the connection of the drive controller.
- 1. Optional: Connect the braking resistor to terminal X21 and attach the terminal. Make sure that the conductors are twisted pairs.
- 2. In order to connect the motor temperature sensor, the control of the brake and the motor itself to the drive controller, wire the cores of the power cables with terminals X2A and X20A.
- 3. Attach the power cable with the shield clamp to the shield contact of terminal X20A.

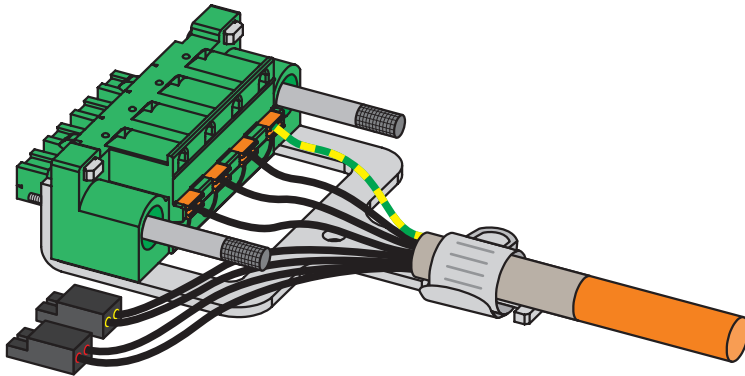

- 4. Attach terminals X20A and X2A and tighten the screws of X20A. After tightening the screws, make sure that there is sufficient distance between the cores.

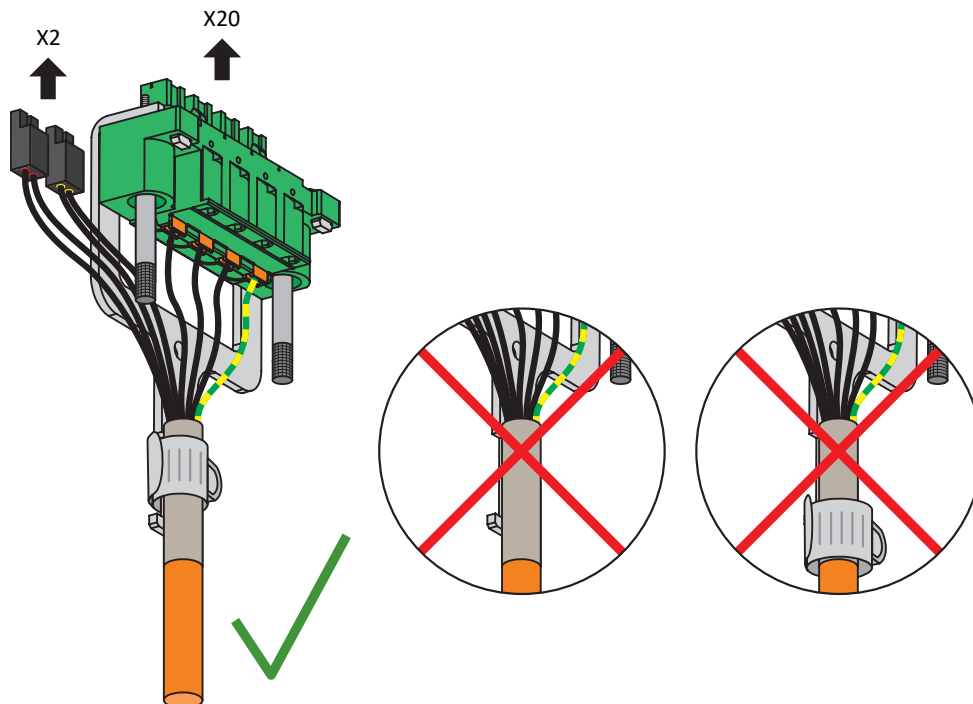

- 5. Optional: Connect the supply voltage for the brakes to terminal X300 and attach it.
- 6. For double-axis controllers: Repeat steps 2 to 4 for the terminals X2B and X20B.
- 7. Optional: Connect an encoder to terminal X4A.
- 8. Optional for double-axis controllers: Connect an encoder to terminal X4B.

Top of the device:

- ✓ You have a system circuit diagram describing the connection of the drive controller.
- 1. Connect the power supply to terminal X10 and attach the terminal.
- 2. Connect the 24 V_{DC} power supply for the control electronics to terminal X11 and attach the terminal.
- 3. If you use the STO safety function, connect it as follows:
 - 3.1. SR6 option: Connect terminal X12 according to your safety configuration and attach the terminal.
 - 3.2. SY6 option: In order to be able to identify the safety module in the FSoE network, you must transfer its unique address in the FSoE network to the drive controller using the DIP switches.
 - 3.3. SU6 option: In order to be able to identify the safety module in the PROFIsafe network, you must transfer its unique address in the PROFIsafe network to the drive controller using the DIP switches.
- 4. Optional: Connect the digital inputs to terminals X101 and X103 and attach the terminals.
- 5. Connect the fieldbus to the sockets X200 and X201.

Examples can be found in the appendix (see [Wiring examples \[▶ 358\]](#)).

11.4 Braking resistor

WARNING!

Risk of burns! Fire hazard! Material damage!

Chokes and braking resistors can heat up to over 100 °C under permitted operating conditions.

- Take protective measures against accidental and intentional contact with the choke or braking resistor.
- Make sure that no flammable material is in the vicinity of the choke or braking resistor.
- Note the specified minimum clearances for installation.

WARNING!

Fire hazard due to overheating!

Using chokes or braking resistors outside of the nominal data (cable length, current, frequency, etc.) can cause them to overheat.

- Always comply with the maximum nominal data when operating the chokes and braking resistors.

Housing grounding of the braking resistor

When grounding the housing of the braking resistor, obey the information on how to connect the grounding conductor correctly (see [Connection of the grounding conductor \[▶ 102\]](#)).

11.4.1 FZMU, FZZMU connection description

The internal connections of the tubular fixed resistor are wired to terminals with heat-resistant, silicone-insulated strands of wire. Also ensure a heat-resistant and sufficiently surge-proof design for the connection!

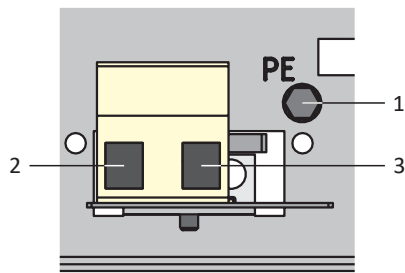

Fig. 29: FZMU connection overview

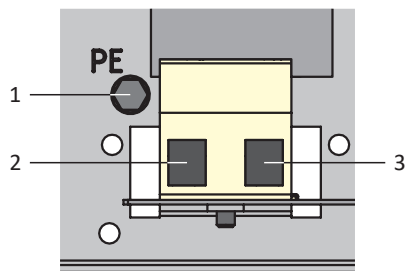

Fig. 30: FZZMU connection overview

No.	Function
1	Grounding conductor
2	RB drive controller braking resistor connection: X21, pin 1
3	RB drive controller braking resistor connection: X21, pin 2

Tab. 130: FZMU, FZZMU connection description

For the connecting wiring of the braking resistor, obey the terminal specification [G 10/2 \[▶ 354\]](#).

11.4.2 GVADU, GBADU connection description

GVADU flat resistors have two red cores for connecting to the drive controller, while GBADU flat resistors have one gray and one white core.

No.	Function
RD/GY	RB drive controller braking resistor connection: X21, pin 1
RD/WH	RB drive controller braking resistor connection: X21, pin 2

Tab. 131: GVADU, GBADU connection description

11.5 Output choke

⚠ WARNING!

Risk of burns! Fire hazard! Material damage!

Chokes and braking resistors can heat up to over 100 °C under permitted operating conditions.

- Take protective measures against accidental and intentional contact with the choke or braking resistor.
- Make sure that no flammable material is in the vicinity of the choke or braking resistor.
- Note the specified minimum clearances for installation.

⚠ WARNING!

Fire hazard due to overheating!

Using chokes or braking resistors outside of the nominal data (cable length, current, frequency, etc.) can cause them to overheat.

- Always comply with the maximum nominal data when operating the chokes and braking resistors.

11.5.1 Connection description

Designation	Function
1U1	Phase U drive controller connection: X20, pin 1
1U2	Motor phase U connection
1V1	Phase V drive controller connection: X20, pin 2
1V2	Motor phase V connection
1W1	Phase W drive controller connection: X20, pin 3
1W2	Motor phase W connection
7	Drive controller grounding conductor: X20, Pin 4
8	Power cable grounding conductor

Tab. 132: TEP output choke connection description

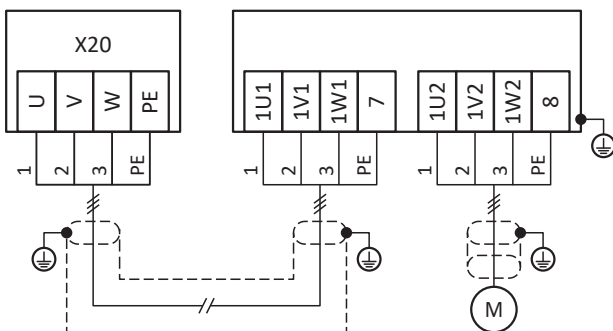

Fig. 31: TEP output choke connection example

Shielded connection of the power cable

Note the following points for the connection of the power cable for a motor with output choke:

- Ground the shield of the power cable over large contact areas in the immediate vicinity of the output choke, for example with electrically conductive metal cable clips on a grounded busbar.
- Keep the exposed conductors as short as possible. All devices and circuits that are sensitive to EMC must be kept at a distance of at least 0.3 m.

The following graphic shows an example of the shielded connection of the power cable.

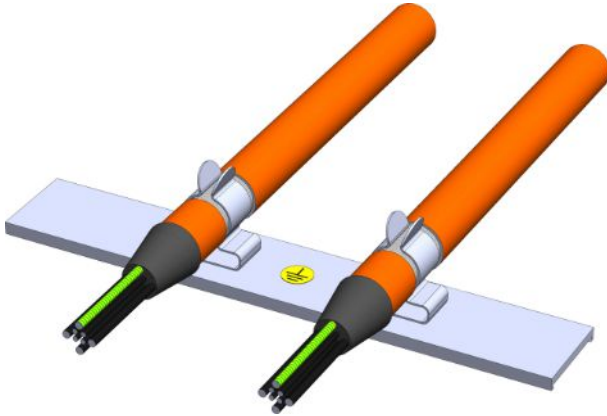

Fig. 32: Shielded connection of the power cable

Choke housing grounding

When connecting the grounding conductor, obey the requirements described (see [Connection of the grounding conductor](#) [▶ 102]).

11.6 Cables

Note that the motor, cables and drive controller each have electrical properties which influence one another. Unfavorable combinations could possibly result in impermissible voltage peaks on the motor and drive controller and increased wear as a result.

Take into consideration the following instructions when selecting suitable cables:

- Cable cross-sections for connection to the motor:
Note the permitted stall current I_0 for the motor when making your selection.
- Conductor cross-sections for the power connection:
Note the line fuse, the maximum permitted conductor cross-section for terminal X10, the routing method and the surrounding temperature when making your selection.
- Also pay attention to the trailing and torsional strength of the lines.
- When using a motor brake, pay attention to the voltage drop in the supply voltage on the line.

Information

To ensure proper functionality, we recommend using cables from STOBER that are matched to the complete system. If unsuitable cables are used, we reserve the right to reject claims under the warranty.

Information

When connecting the cables, refer to the motor connection diagram that is delivered with every STOBER motor.

11.6.1 Power cables

The synchronous servo motors and Lean motors are equipped with plug connectors as standard, while asynchronous motors are equipped with terminal boxes.

STOBER provides suitable cables in various lengths, conductor cross-sections and connector sizes.

11.6.1.1 Connection description

Depending on the size of the motor plug connector, power cables are available in the following designs:

- Quick lock for con.15
- speedtec quick lock for con.23 and con.40

Information

Observe the designations on the identification clips for the correct connection of the cores.

Motor-side connection

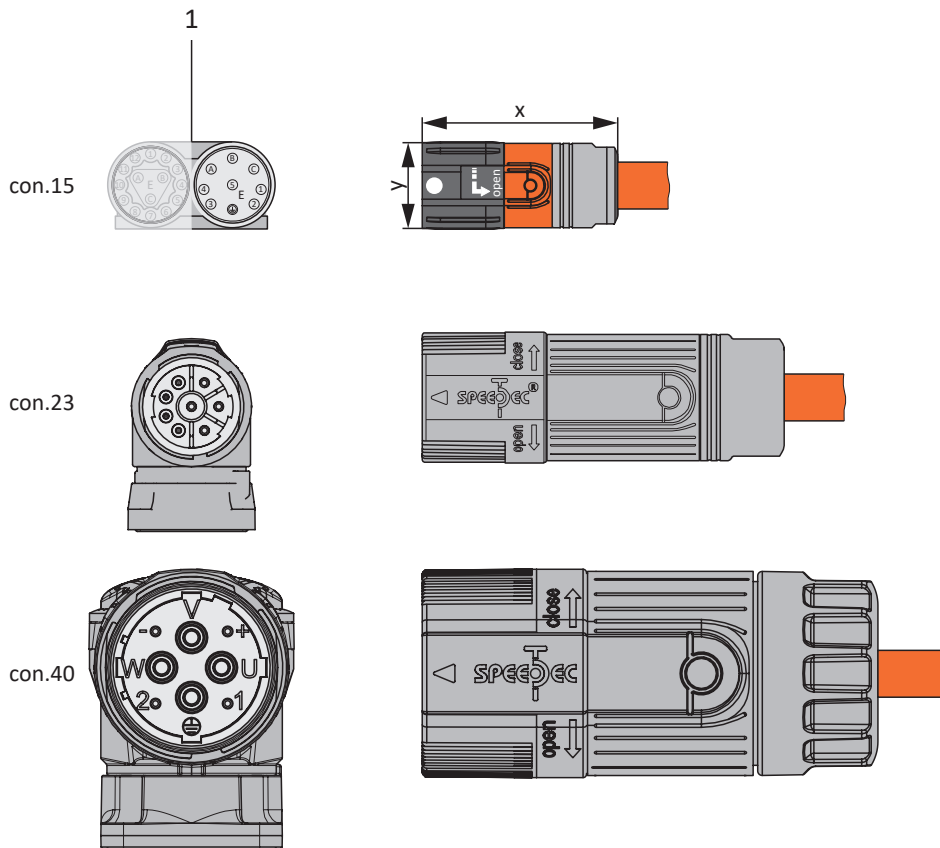

1 Plug connectors

Drive controller-side connection

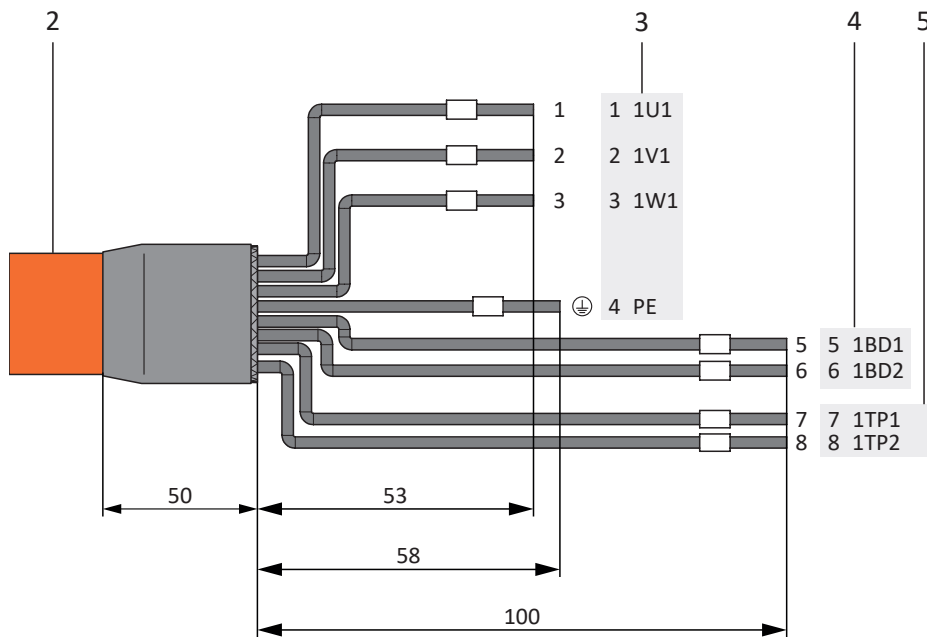

- 2 Power cable with cable shield
- 3 Connection to terminal X20, motor
- 4 Connection of terminal X2, brake
- 5 Connection to terminal X2, temperature sensor

Maximum cable length

Motor type	Connection	Size 0 to 2
Synchronous servo motor, asynchronous motor	Without output choke	50 m, shielded
Synchronous servo motor, asynchronous motor	With output choke	100 m, shielded
Lean motor	Without output choke	50 m, shielded ^{a)}

Tab. 133: Maximum cable length of the power cable [m]

The use of cables with a length greater than 50 m and up to maximum 100 m must be checked by STOBER for the application.

Power cables – con.15 plug connector

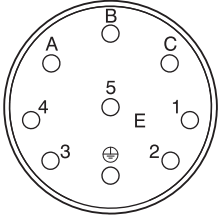
Motor connection diagram	Motor (1)		Cable (2)	Drive controller (3) – (5)		
	Pin	Designation	Identification/ Core color	Pin X20	Pin X2	Pin X2
	A	1U1	1	1	—	—
	B	1V1	2	2	—	—
	C	1W1	3	3	—	—
	1	1TP1	7	—	—	7
	2	1TP2	8	—	—	8
	3	1BD1	5	—	5	—
	4	1BD2	6	—	6	—
	5	—	—	—	—	—
	⊕	PE	GNYE	4	—	—
	Housing	Shield	—	Shield contact	—	—

Tab. 134: con.15 power cable pin assignment

Length x [mm]	Diameter y [mm]
42	18.7

Tab. 135: con.15 connector dimensions

Power cables – con.23 plug connector

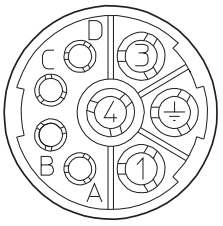
Motor connection diagram	Motor (1)		Cable (2)	Drive controller (3) – (5)		
	Pin	Designation	Identification/ Core color	Pin X20	Pin X2	Pin X2
	1	1U1	1	1	—	—
	3	1V1	2	2	—	—
	4	1W1	3	3	—	—
	A	1BD1	5	—	5	—
	B	1BD2	6	—	6	—
	C	1TP1	7	—	—	7
	D	1TP2	8	—	—	8
	⊕	PE	GNYE	4	—	—
	Housing	Shield	—	Shield contact	—	—

Tab. 136: con.23 power cable pin assignment

Length x [mm]	Diameter y [mm]
78	26

Tab. 137: con.23 connector dimensions

Power cables – con.40 plug connector

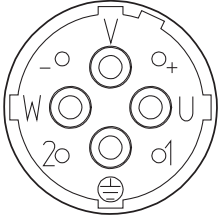
Motor connection diagram	Motor (1)		Cable (2)	Drive controller (3) – (5)		
	Pin	Designation	Identification/ Core color	Pin X20	Pin X2	Pin X2
	U	1U1	1	1	—	—
	V	1V1	2	2	—	—
	W	1W1	3	3	—	—
	+	1BD1	5	—	5	—
	-	1BD2	6	—	6	—
	1	1TP1	7	—	—	7
	2	1TP2	8	—	—	8
	⊕	PE	GNYE	4	—	—
	Housing	Shield	—	Shield contact	—	—

Tab. 138: con.40 power cable pin assignment

Length x [mm]	Diameter y [mm]
99	46

Tab. 139: con.40 connector dimensions

11.6.2 Encoder cables

The motors are equipped with encoder systems and plug connectors as standard.

STOBER provides suitable cables in various lengths, conductor cross-sections and connector sizes.

Depending on the respective motor types, different encoder systems can be used.

11.6.2.1 EnDat 2.1/2.2 digital encoders

Suitable encoder cables are described below.

11.6.2.1.1 Connection description

Depending on the size of the motor plug connector, encoder cables are available in the following designs:

- Quick lock for con.15
- speedtec quick lock for con.17 and con.23

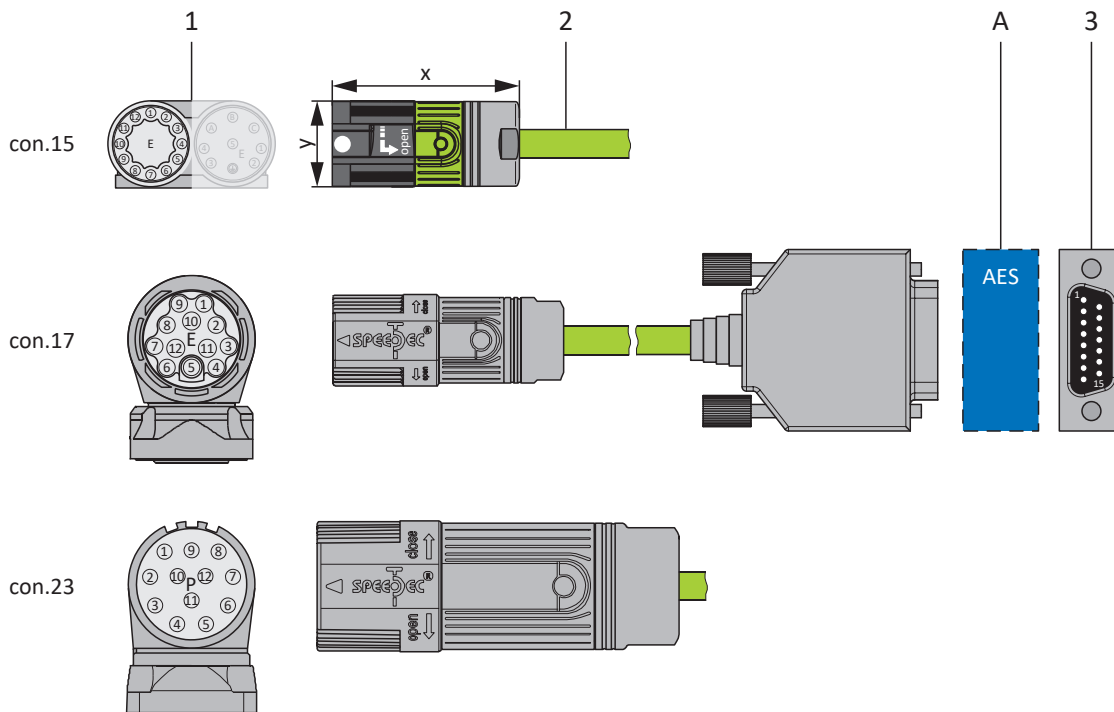

- 1 Plug connectors
- 2 Encoder cables
- A Only con.15 and con.17: Optional Absolute Encoder Support (AES) battery module
- 3 D-sub X4

Encoder cables – con.15 plug connectors

The supply voltage is buffered for EnDat 2.2 digital "EBI 1135" and "EBI 135" inductive encoders with a multi-turn function. In this case, pin 2 and pin 3 of the motor are assigned to the U_{2BAT} buffer battery. Note that the encoder cable must not be connected to the encoder interface of the drive controller, but rather to the AES battery module for these encoders.

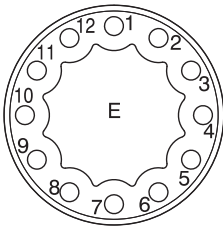
Motor (1)		Cable (2)	Drive controller (3)	
Connection diagram	Pin	Designation	Core color	
	1	Clock +	YE	Pin X4 8
	2	U_{2BAT+} ¹⁸	PK	12
	3	U_{2BAT-} ¹⁹	GY	3
	4	—	—	—
	5	Data –	BN	13
	6	Data +	WH	5
	7	—	—	—
	8	Clock –	GN	15
	9	—	—	—
	10	0 V GND	BU	2
	11	—	—	—
	12	U_2	RD	4
	Housing	Shield	—	Housing

Tab. 140: con.15 encoder cable pin assignment, EnDat 2.1/2.2 digital

Length x [mm]	Diameter y [mm]
42	18.7

Tab. 141: con.15 connector dimensions

¹⁸ Only relevant for EBI encoders

¹⁹ Only relevant for EBI encoders

Encoder cables – con.17 plug connectors

The supply voltage is buffered for EnDat 2.2 digital "EBI 1135" and "EBI 135" inductive encoders with a multi-turn function. In this case, pin 2 and pin 3 of the motor are assigned to the U_{2BAT} buffer battery. Note that the encoder cable must not be connected to the encoder interface of the drive controller, but rather to the AES battery module for these encoders.

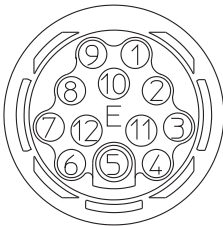
Motor (1)		Cable (2)	Drive controller (3)
Connection diagram	Pin	Designation	Core color
	1	Clock +	YE
	2	U_{2BAT+}^{20}	PK
	3	U_{2BAT-}^{21}	GY
	4	—	—
	5	Data –	BN
	6	Data +	WH
	7	—	—
	8	Clock –	GN
	9	—	—
	10	0 V GND	BU
	11	—	—
	12	U_2	RD
	Housing	Shield	—

Tab. 142: con.17 encoder cable pin assignment, EnDat 2.1/2.2 digital

Length x [mm]	Diameter y [mm]
56	22

Tab. 143: con.17 connector dimensions

²⁰ Only relevant for EBI encoders

²¹ Only relevant for EBI encoders

Encoder cables – con.23 plug connectors

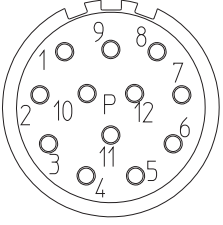
Connection diagram	Motor (1)		Cable (2)	Drive controller (3)
	Pin	Designation	Core color	Pin X4
	1	Clock +	YE	8
	2	—	—	—
	3	—	—	—
	4	—	—	—
	5	Data -	BN	13
	6	Data +	WH	5
	7	—	—	—
	8	Clock -	GN	15
	9	—	—	—
	10	0 V GND	BU	2
	11	—	—	—
	12	U ₂	RD	4
	Housing	Shield	—	Housing

Tab. 144: con.23 encoder cable pin assignment, EnDat 2.1/2.2 digital

Length x [mm]	Diameter y [mm]
58	26

Tab. 145: con.23 plug dimensions

11.6.2.2 SSI encoders

Suitable encoder cables are described below.

11.6.2.2.1 Connection description

The encoder cable is available in plug connector size con.23 with a speedtec quick lock.

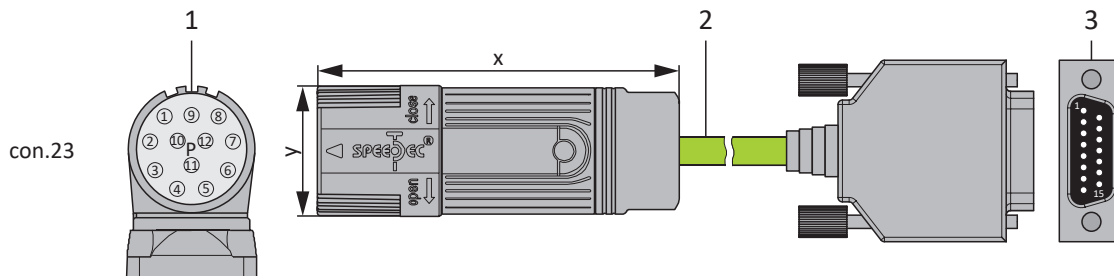

- 1 Plug connectors
- 2 Encoder cables
- 3 D-sub X4

Encoder cables – con.23 plug connectors

Motor (1)		Cable (2)	Drive controller (3)	
Connection diagram	Pin	Designation	Core color	Pin X4
	1	Clock +	YE	8
	2	U ₂ Sense	PK	12
	3	—	—	—
	4	—	—	—
	5	Data –	BN	13
	6	Data +	WH	5
	7	—	—	—
	8	Clock –	GN	15
	9	—	—	—
	10	0 V GND	BU	2
	11	—	—	—
	12	U ₂	RD	4
	Housing	Shield	—	Housing

Tab. 146: con.23 encoder cable pin assignment, SSI

Length x [mm]	Diameter y [mm]
58	26

Tab. 147: con.23 plug dimensions

11.6.2.3 Differential HTL incremental encoders

Suitable encoder cables are described below.

11.6.2.3.1 Connection description

The encoder cable is available in plug connector size con.23 with a speedtec quick lock.

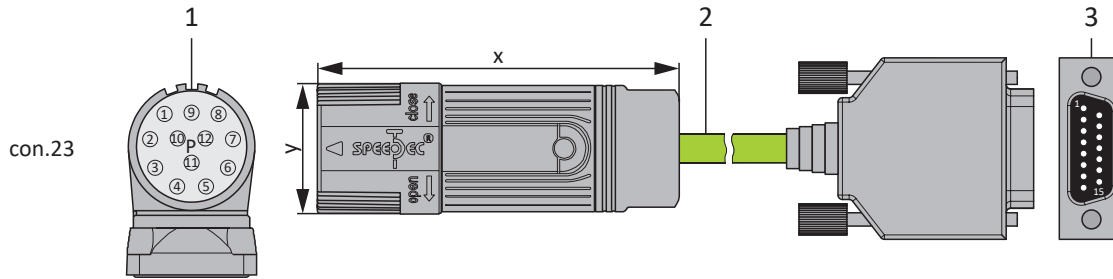

- 1 Plug connectors
- 2 Encoder cables
- 3 D-sub X4

Information

For the connection of an HTL incremental encoder to terminal X4 of SC6 or SI6 drive controllers, you need the HT6 adapter (ID No. 56665). HT6 takes over level conversion from HTL signals to TTL signals.

Encoder cables – con.23 plug connectors

Motor (1)		Cable (2)	Drive controller (3)	
Connection diagram	Pin	Designation	Core color	
	1	B -	YE	9
	2	—	—	—
	3	N +	PK	3
	4	N -	GY	10
	5	A +	BN	6
	6	A -	WH	11
	7	—	—	—
	8	B +	GN	1
	9	—	—	—
	10	0 V GND	BU	2 ²²
	11	—	—	—
	12	U ₂	RD	4
	Housing	Shield	—	Housing

Tab. 148: con.23 encoder cable pin assignment, incremental HTL

Length x [mm]	Diameter y [mm]
58	26

Tab. 149: con.23 plug dimensions

²² Pin 12 (U₂ Sense) with pin 2 (0 V GND) bridged: The bridge is constructed in the cable connector that is connected to X4.

11.6.2.4 Resolver

Suitable encoder cables are described below.

11.6.2.4.1 Connection description

Depending on the size of the motor plug connector, encoder cables are available in the following designs:

- Quick lock for con.15
- speedtec quick lock for con.17 and con.23

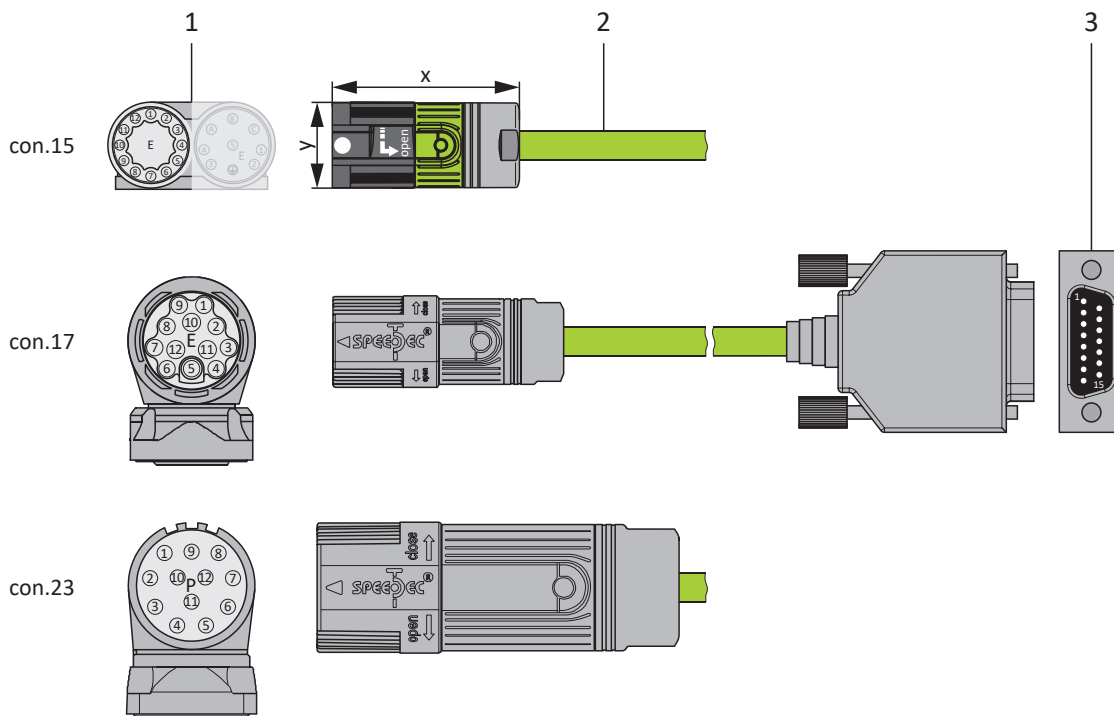

- 1 Plug connectors
- 2 Encoder cables
- 3 D-sub X4/adapter

Information

Note that the cores for the temperature sensor are routed in the power cable as standard. For motors that provide the temperature sensor at the encoder connection, you need an interface adapter to lead out the temperature sensor cores for connecting the cable to the drive controller.

Information

For connecting con.23 resolver cables with a 9-pin D-sub connector, such as the standard design for ED/EK synchronous servo motors, you must use interface adapter AP6A00 (ID No. 56498) or AP6A01 (ID No. 56522, with motor temperature sensor leads), available separately.

11.6.2.4.1.1 Resolver cable with "No. 44206" imprint

Encoder cables – con.15 plug connectors

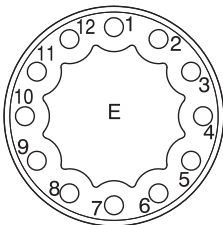
Connection diagram	Motor (1)		Cable (2)	Drive controller (3)
	Pin	Designation	Core color	Pin X4
	1	S3 Cos +	YE	3
	2	S1 Cos –	GN	11
	3	S4 Sin +	WH	1
	4	S2 Sin –	BN	9
	5	1TP1	RD	7
	6	1TP2	BU	14
	7	R2 Ref +	GY	6
	8	R1 Ref –	PK	2
	9	–	–	–
	10	–	–	–
	11	–	–	–
	12	–	–	–
	Housing	Shield	–	Housing

Tab. 150: Encoder cable pin assignment con.15, resolver, "No. 44206" cable label

Length x [mm]	Diameter y [mm]
42	18.7

Tab. 151: con.15 connector dimensions

Encoder cables – con.17 plug connectors

Connection diagram	Motor (1)		Cable (2)	Drive controller (3)
	Pin	Designation	Core color	Pin X4
	1	S3 Cos +	YE	3
	2	S1 Cos –	GN	11
	3	S4 Sin +	WH	1
	4	S2 Sin –	BN	9
	5	1TP1	RD	7
	6	1TP2	BU	14
	7	R2 Ref +	GY	6
	8	R1 Ref –	PK	2
	9	–	–	–
	10	–	–	–
	11	–	–	–
	12	–	–	–
	Housing	Shield	–	Housing

Tab. 152: Encoder cable pin assignment con.17, resolver, "No. 44206" cable label

Length x [mm]	Diameter y [mm]
56	22

Tab. 153: con.17 connector dimensions

Encoder cables – con.23 plug connectors

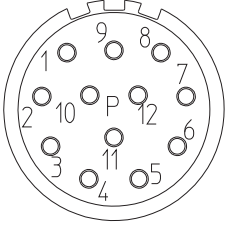
Connection diagram	Motor (1)		Cable (2)	Adapter (3)
	Pin	Designation	Core color	Pin 9-pin connector
	1	S3 Cos +	YE	8
	2	S1 Cos -	GN	4
	3	S4 Sin +	WH	7
	4	S2 Sin -	BN	3
	5	1TP1	RD	2
	6	1TP2	BU	6
	7	R2 Ref +	GY	9
	8	R1 Ref -	PK	5
	9	—	—	—
	10	—	—	—
	11	—	—	—
	12	—	—	—
	Housing	Shield	—	Housing

Tab. 154: Encoder cable pin assignment con.23, resolver, "No. 44206" cable label

Length x [mm]	Diameter y [mm]
58	26

Tab. 155: con.23 plug dimensions

11.6.2.4.1.2 Resolver cable with "Motion Resolver" imprint

Encoder cables – con.15 plug connectors

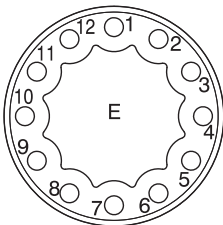
Connection diagram	Motor (1)		Cable (2)		Drive controller (3)
	Pin	Designation	Core color	Pair	Pin X4
	1	S3 Cos +	GN	GN-BK	3
	2	S1 Cos –	BK	GN-BK	11
	3	S4 Sin +	WH	WH-BK	1
	4	S2 Sin –	BK	WH-BK	9
	5	1TP1	RD	RD-BK	7
	6	1TP2	BK	RD-BK	14
	7	R2 Ref +	BU	BU-BK	6
	8	R1 Ref –	BK	BU-BK	2
	9	–	–	–	–
	10	–	–	–	–
	11	–	–	–	–
	12	–	–	–	–
	Housing	Shield	–	–	Housing

Tab. 156: Encoder cable pin assignment con.15, resolver, "Motion Resolver" cable label

Length x [mm]	Diameter y [mm]
42	18.7

Tab. 157: con.15 connector dimensions

Encoder cables – con.17 plug connectors

Connection diagram	Motor (1)		Cable (2)		Drive controller (3)
	Pin	Designation	Core color	Pair	Pin X4
	1	S3 Cos +	GN	GN-BK	3
	2	S1 Cos –	BK	GN-BK	11
	3	S4 Sin +	WH	WH-BK	1
	4	S2 Sin –	BK	WH-BK	9
	5	1TP1	RD	RD-BK	7
	6	1TP2	BK	RD-BK	14
	7	R2 Ref +	BU	BU-BK	6
	8	R1 Ref –	BK	BU-BK	2
	9	–	–	–	–
	10	–	–	–	–
	11	–	–	–	–
	12	–	–	–	–
	Housing	Shield	–	–	Housing

Tab. 158: Encoder cable pin assignment con.17, resolver, "Motion Resolver" cable label

Length x [mm]	Diameter y [mm]
56	22

Tab. 159: con.17 connector dimensions

Encoder cables – con.23 plug connectors

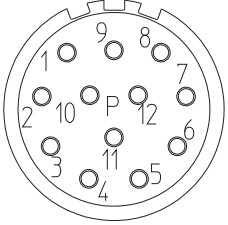
Connection diagram	Motor (1)		Cable (2)		Adapter (3)
	Pin	Designation	Core color	Pair	Pin 9-pin connector
	1	S3 Cos +	GN	GN-BK	8
	2	S1 Cos –	BK	GN-BK	4
	3	S4 Sin +	WH	WH-BK	7
	4	S2 Sin –	BK	WH-BK	3
	5	1TP1	RD	RD-BK	2
	6	1TP2	BK	RD-BK	6
	7	R2 Ref +	BU	BU-BK	9
	8	R1 Ref –	BK	BU-BK	5
	9	–	–	–	–
	10	–	–	–	–
	11	–	–	–	–
	12	–	–	–	–
	Housing	Shield	–	–	Housing

Tab. 160: Encoder cable pin assignment con.23, resolver, "Motion Resolver" cable label

Length x [mm]	Diameter y [mm]
58	26

Tab. 161: con.23 plug dimensions

11.6.3 One Cable Solution

The synchronous servo motors are equipped with plug connectors as standard.

A motor connection as a One Cable Solution (OCS) combined with an EnDat 3 or HIPERFACE DSL encoder requires hybrid cables which feature encoder communication and power transmission in a shared cable.

STOBER provides suitable cables in various lengths, conductor cross-sections and connector sizes.

For applications with a cable length of up to 12.5 m, conductor cross-sections of 1.0 or 1.5 mm² and a non-moving installation, STOBER recommends the OCS-Basic hybrid cables. For longer lengths or installation in moving cable runs (such as a drag chain), use the OCS-Advanced hybrid cables.

Information

For connecting as a One Cable Solution, use exclusively hybrid cables from STOBER. The use of unsuitable cables or poorly made connections can cause subsequent damage. For this reason, we reserve the right to reject claims under the warranty in this case.

11.6.3.1 Connection description

The hybrid cables are available in plug connector size con.23 with a speedtec quick lock.

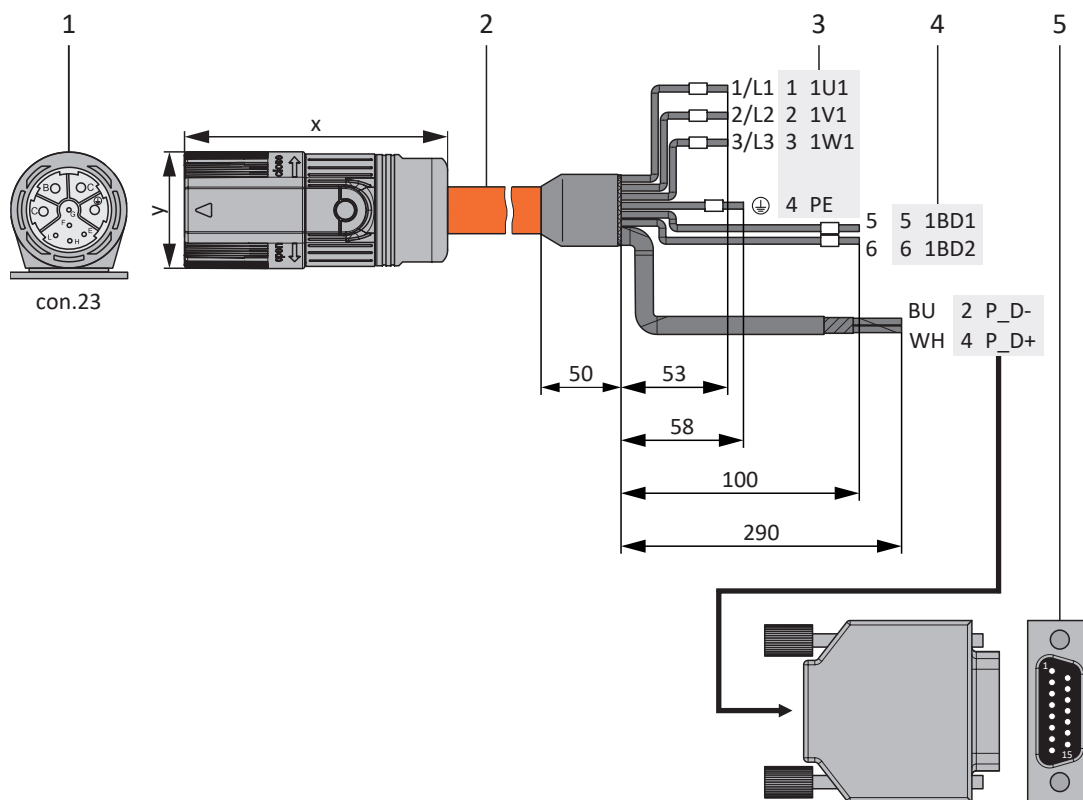

- 1 Plug connectors
- 2 Hybrid cables
- 3 Connection to terminal X20, motor
- 4 Connection of terminal X2, brake
- 5 D-sub X4

Hybrid cables – con.23 plug connectors

Connection diagram	Motor (1)		Cable (2)	Drive controller (3) – (5)		
	Pin	Designation	Core No./ Core color	Pin X20	Pin X2	Pin X4
	A	1U1	1/L1	1	—	—
	B	1V1	2/L2	2	—	—
	C	1W1	3/L3	3	—	—
	E	P_D-	BU	—	—	2
	F	P_D shield	—	—	—	Housing
	G	1BD1	5	—	5	—
	H	P_D+	WH	—	—	4
	L	1BD2	6	—	6	—
		PE	GNYE	4	—	—
	Housing	Shield	—	Shield contact	—	—

Tab. 162: con.23 hybrid cable pin assignment

Length x [mm]	Diameter y [mm]
78	26

Tab. 163: con.23 connector dimensions

12 Operation

The S1 operating button is located on the top of the device and can be used to save the configuration to the drive controller in non-volatile memory, for example.

12.1 S1 operating button of the drive controller

A drive controller hardware version ≥ 50 and firmware version V 6.5-L or later (nameplate: HW ≥ 50 ; parameter: E52[1] ≥ 50) are required for the S1 operating button. The operating button is located on the top of the drive controller.

Overriding a fixed IP address upon device start-up

If the drive controller has a fixed IP address that does not match the subnet of the PC, press and hold the operating button when switching on the 24 V supply until all 3 LEDs go out (approx. 3 s after switching on). The IP address is then assigned either automatically by DriveControlSuite or via DHCP, regardless of the setting in A166. In this case, the operating button acts as an override.

Non-volatile storage in operation

To save the configuration to the drive controller in non-volatile memory, press and hold the operating button for 3 s.

Activating and executing a function in operation

The following additional functions are available to you:

- 1: Temporarily deactivate the fan (A15 = 0: Inactive)
- 2: Acknowledge faults in both axes

Information

Function 1 is used exclusively for project configuration and commissioning purposes; using it in normal or automatic mode is not permitted.

At a power unit temperature E25[0] greater than 45 °C or a control unit temperature E25[1] greater than 60 °C, an inactive fan is switched on automatically (A15 = 1: Active). The fan can be deactivated once. As soon as the fan is activated again afterwards, the drive controller must be restarted to deactivate the fan. It is not possible to deactivate it again using the S1 operating button.

To activate and execute one of these functions, proceed as follows:

1. To activate function selection, press the operating button briefly (< 3 s).
 - ⇒ Both LEDs light up for approx. 1 s.
 - ⇒ Then only the green LED lights up.
 - ⇒ Function 1 is selected (default).
2. Then press the operating button again to change the function.
 - ⇒ The LEDs on the front of the drive controller light up depending on the selected function.
3. To confirm the selected function, press and hold the operating button for 3 s.
 - ⇒ Both LEDs flash twice.
 - ⇒ The selected function is executed.
 - ⇒ The LEDs then switch back to the normal operating display.

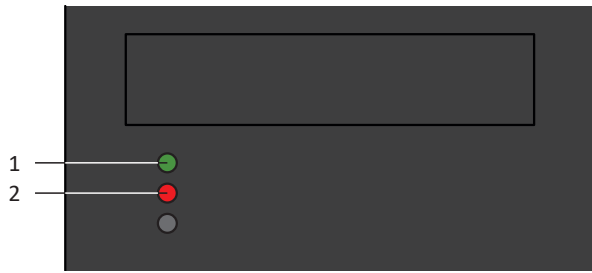

Fig. 33: LEDs for the functions of the S1 operating button

- 1 Green
- 2 Red

LEDs: (Green/Red)	Conduct	Role
	On	1: Temporarily deactivate the fan (A15 = 0: Inactive)
	Off	
	Off	2: Acknowledge faults in both axes
	On	

Tab. 164: Status of the LEDs when selecting functions via the S1 operating button

Acknowledging the function selection

If the operating button is not pressed again within 10 s of activating the function selection, the function selection is exited and the LEDs switch back to the normal operating display.

13 What you should know before commissioning

The following chapters provide a quick introduction to the structure of the program interface and accompanying window designations as well as relevant information about parameters and generally saving your project configuration.

13.1 DS6 program interface

Using the graphical interface of the DriveControlSuite commissioning software (DS6), you can project, parameterize and commission your drive project quickly and efficiently. In case of service, you can evaluate diagnostic information such as operating states, fault memories and fault counters of your drive project using DriveControlSuite.

Information

The program interface of DriveControlSuite is available in German, English and French. To change the language of the program interface, select Settings > Language.

Information

The DriveControlSuite help in the menu bar can be reached via Help > Help for DS6 or via the [F1] key on your keyboard. When you press [F1] in an area of the program, the corresponding help topic opens.

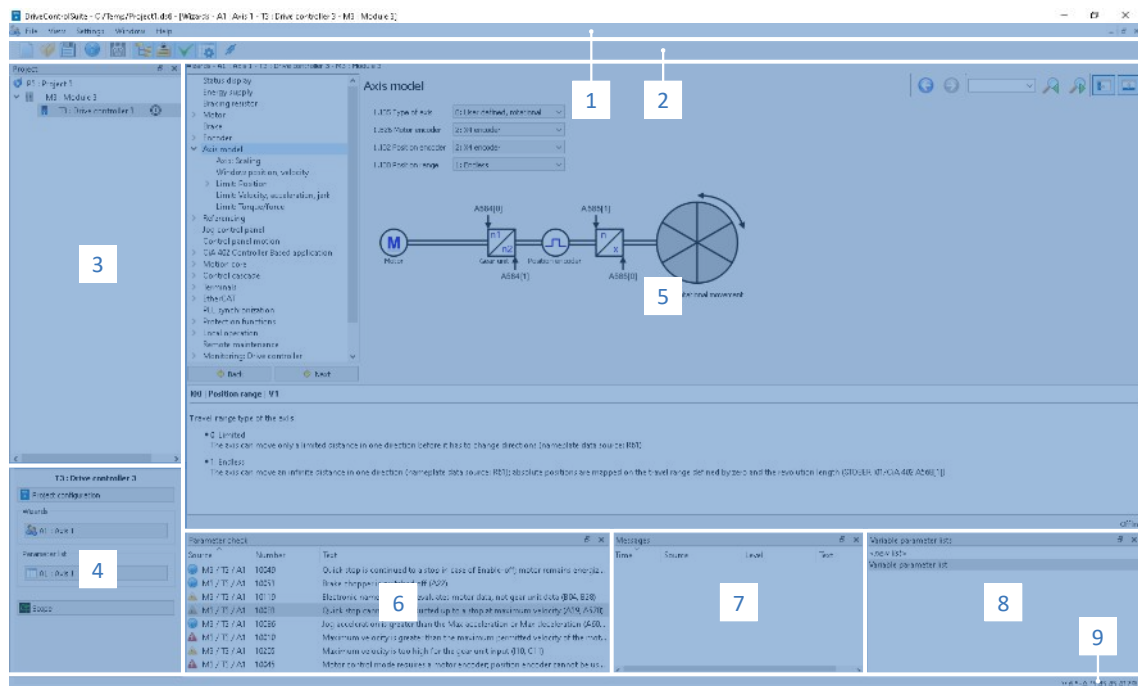

Fig. 34: DS6: Program interface

No.	Area	Description
1	Menu bar	Using the File, View, Settings and Window menus, you can open and save projects, display and hide program windows, select the interface language and access level and change between different windows in the workspace.
2	Toolbar	The toolbar enables quick access to frequently needed functions, like opening and saving projects and hiding and displaying windows in the program interface.
3	Project tree	The project tree forms the structure of your drive project in the form of modules and drive controllers. Select an element using the project tree first in order to edit it using the project menu.
4	Project menu	The project menu offers you various functions for editing the project, module and drive controller. The project menu adapts to the element that you selected in the project tree.
5	Workspace	The different windows which can be used to edit your drive project, such as the configuration dialog, wizards, the parameter list or the scope analysis tool, open in the workspace.
6	Parameter check	The parameter check points out irregularities and inconsistencies that were detected in the plausibility check of calculable parameters.
7	Messages	The entries in the messages log the connection and communication status of the drive controllers, incorrect inputs caught by the system, errors when opening a project or rule violations in the graphical programming.
8	Variable parameter lists	You can use variable parameter lists to compile any parameters in individual parameter lists for a quick overview.
9	Status bar	In the status bar, you can find the specifications of the software version and get additional information about the project file, the devices and the progress of the process during processes such as loading projects.

13.2 Meaning of parameters

You can use parameters to adapt the function of the drive controller to your individual application. In addition, parameters visualize the current actual values (actual velocity, actual torque, etc.) and trigger actions such as Save values, Test phase, etc.

Interpretation of parameter identification

Parameter identification consists of the following elements, where short forms are also possible, i.e. only specifying a coordinate or the combination of coordinate and name.

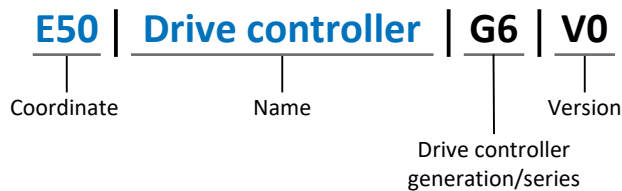

13.2.1 Parameter groups

Parameters are assigned to individual groups by topic. The drive controllers differentiate between the following parameter groups.

Group	Topic
A	Drive controllers, communication, cycle times
B	Motor
C	Machine, velocity, torque/force, comparators
D	Set value
E	Display
F	Terminals, analog and digital inputs and outputs, brake
G	Technology – Part 1 (application-dependent)
H	Encoder
I	Motion (all motion settings)
J	Motion blocks
K	Control panel
L	Technology – Part 2 (application-dependent)
M	Profiles (application-dependent)
N	Additional functions (application-dependent; e.g. extended cam control unit)
P	Customer-specific parameters (programming)
Q	Customer-specific parameters, instance-dependent (programming)
R	Production data for the drive controller, motor, brakes, motor adapter, gear unit and geared motor
S	Safety (safety technology)
T	Scope
U	Protection functions
Z	Fault counter

Tab. 165: Parameter groups

13.2.2 Parameter types and data types

In addition to topic-based sorting in individual groups, all parameters belong to a certain data type and parameter type. The data type of a parameter is displayed in the parameter list, properties table. The connections between parameter types, data types and their value range can be found in the following table.

Data type	Parameter type	Length	Value range (decimal)
INT8	Integer or selection	1 byte (signed)	-128 – 127
INT16	Integer	2 bytes (1 word, signed)	-32768 – 32767
INT32	Integer or position	4 bytes (1 double word, signed)	-2 147 483 648 – 2 147 483 647
BOOL	Binary number	1 bit (internal: LSB in 1 byte)	0, 1
BYTE	Binary number	1 byte (unsigned)	0 – 255
WORD	Binary number	2 bytes (1 word, unsigned)	0 – 65535
DWORD	Binary number or parameter address	4 bytes (1 double word, unsigned)	0 – 4 294 967 295
REAL32 (single type according to IEE754)	Floating-point number	4 bytes (1 double word, signed)	$-3.40282 \times 10^{38} - 3.40282 \times 10^{38}$
STR8	Text	8 characters	—
STR16	Text	16 characters	—
STR80	Text	80 characters	—

Tab. 166: Parameters: Data types, parameter types, possible values

Parameter types: Use

- Integer, floating-point number
For general computing processes
Example: Set and actual values
- Selection
Numeric value to which a direct meaning is assigned
Example: Sources for signals or set values
- Binary number
Bit-oriented parameter information that is collected in binary
Example: Control and status words
- Position
Integer combined with associated units and decimal places
Example: Actual and set values of positions
- Velocity, acceleration, deceleration, jerk
Floating-point number combined with associated units
Example: Actual and set values for velocity, acceleration, deceleration, jerk
- Parameter address
Referencing of a parameter
Example: In F40 AO1 source, for example, E08 n-motor filtered can be parameterized
- Text
Outputs or messages

13.2.3 Parameter types

The following types of parameters are differentiated.

Parameter type	Description	Example
Simple parameters	Consist of one group and one line with a defined value.	A21 Brake resistor R: Value = 100 ohms
Array parameters	Consist of a group, a line and multiple sequential (listed) elements, which have the same properties but different values.	A10 Access level <ul style="list-style-type: none"> ▪ A10[0] access level: Value = Access level via operating unit ▪ A10[2] access level: Value = Access level via CANopen and EtherCAT ▪ A10[4] access level: Value = Access level via PROFINET
Record parameters	Consist of a group, a line and multiple sequential (listed) elements, which can have different properties and different values.	A00 Save values <ul style="list-style-type: none"> ▪ A00[0] Start: Value = Start action ▪ A00[1] Progress: Value = Display action progress ▪ A00[2] Result: Value = Display action result

Tab. 167: Parameter types

13.2.4 Parameter structure

Every parameter has specific coordinates with the following structure.

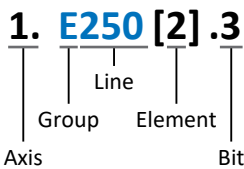

- Axis (optional)
In case of multiple axes, the one to which a parameter is assigned; not applicable for global parameters (value range: 1 – 4).
- Group
The thematic group to which a parameter belongs (value range: A – Z).
- Line
Distinguishes the parameters within a parameter group (value range: 0 – 999).
- Element (optional)
Elements of an array or record parameter (value range: 0 – 16000).
- Bit (optional)
Selection of a single bit for complete data addressing; depends on the data type (value range: 0 – 31).

13.2.5 Parameter visibility

The visibility of a parameter is controlled by the access level you set in DriveControlSuite and by the properties you project for the respective drive controller (e.g. hardware, firmware and application). A parameter can also be shown or hidden depending on other parameters or settings. For example, the parameters of an additional function are only shown as soon as you activate the relevant additional function.

Access level

The access options for the individual software parameters are ranked hierarchically and divided into individual levels. This means that parameters can be hidden for a specific purpose and, relatedly, their configuration options can be locked starting from a specific level.

Each parameter has one access level for read access (visibility) and one access level for write access (editability). The following levels are present:

- Level 0
Elementary parameters
- Level 1
Important parameters of an application
- Level 2
Important parameters for service with extensive diagnostic options
- Level 3
All parameters needed for commissioning and optimizing an application

The parameter A10 Access level controls general access to parameters:

- Over CANopen or EtherCAT (A10[2])
- Over PROFINET (A10[3])

Information

It is not possible to write to or read the parameter hidden in DriveControlSuite during communication via fieldbus.

Hardware

Which parameters are available to you in DriveControlSuite is determined by which series you select in the configuration dialog for the drive controller, for example, or whether you project an option module. Basically, the only parameters that are displayed are the ones you need to parameterize the configured hardware.

Firmware

Due to the further development and updating of functions for the drive controllers, new parameters and also new versions of existing parameters are continuously being implemented in DriveControlSuite and in the firmware. The parameters are displayed in the software according to the DriveControlSuite version used and the configured firmware version of the respective drive controller.

Applications

Applications generally differ in terms of functions and their control. For this reason, different parameters are available with each application.

13.3 Signal sources and process data mapping

The transmission of control signals and set values in DriveControlSuite meets the following principles.

Signal sources

Drive controllers are controlled either over a fieldbus, using mixed operation consisting of a fieldbus system and terminals or exclusively using terminals.

You can use the corresponding selection parameters, referred to as signal sources, to configure whether the control signals and set values of the application are obtained over a fieldbus or using terminals.

In case of activation over a fieldbus, parameters that are selected as data sources for control signals or set values must be part of the subsequent process data mapping. In the case of activation using terminals, the respective analog or digital inputs are specified directly.

Process data mapping

If you are working with a fieldbus system and have selected the source parameters for control signals and set values, configure the fieldbus-specific settings, e.g. the assignment of the process data channels for transmitting receive and transmit process data, as the last step. The respective procedure can be found in the accompanying fieldbus manuals.

13.4 Non-volatile memory

All project configurations, parameterizations and related changes to parameter values are in effect after transmission to the drive controller, but are only stored in volatile memory.

Saving to a drive controller

To save the configuration in non-volatile memory on a drive controller, you have the following options:

- Saving the configuration using the *Save values wizard*:
Project menu > Wizards area > Projected axis > Save values wizard: Select the Save values action
- Saving the configuration using the parameter list:
Project menu > Parameter list area > Projected axis > Group A: Drive controller > A00 Save values: Set the parameter A00[0] to the value 1: Active
- Saving the configuration using the S1 operating button:
Drive controller with S1 operating button: Press and hold the operating button for 3 s

Saving to all drive controllers within a project

To save the configuration in non-volatile memory on several drive controllers, you have the following options:

- Saving the configuration using the toolbar:
Toolbar > Save values icon: Click the Save values icon
- Saving the configuration using the Online functions window:
Project menu > Online connection button > Online functions window: Click on Save values (A00)

Information

Do not shut off the drive controller while saving. If the supply voltage to the control unit is interrupted while saving, the drive controller will start with fault 40: Invalid data the next time it is switched on. To successfully complete the saving procedure, the configuration must be stored again in non-volatile memory.

14 Commissioning

The following chapters describe how to commission your drive system using the DriveControlSuite commissioning software.

Information on system requirements and software installation can be found in the appendix (see [DriveControlSuite \[▶ 366\]](#)).

For the components of your axis model, we require one of the following two combinations as an **example**:

Synchronous servo motor with EnDat 2.2 digital or EnDat 3 encoder (and optional brake)

These motors are saved along with all relevant data for the project configuration in the DriveControlSuite motor database and in the electronic nameplate.

Upon selecting the motor from the database, such as when reading out the nameplate, all data is transferred to the corresponding parameters. There is no need for complex parameterization of the motor, encoder and brake.

LM Lean motor without encoder (with optional brake)

These motors are stored in the motor database of the DriveControlSuite, along with all the data relevant for project configuration. Furthermore, the motor data and the release and engaging times of the brake are part of the firmware. Upon selecting the desired motor from the database, all data is transmitted to the corresponding parameters. The release and engaging times of the brake are also stored. If a brake is present, you must only activate this manually. However, complex parameterization of the motor and brake is not necessary.

For asynchronous motors, the motor data relevant for project configuration is also taken from the motor database. All other motor types, as well as motors from third-party manufacturers, need to have their parameters configured manually.

Make sure that the system nodes are wired and supplied with control voltage before commissioning.

Information

The commissioning process described below is particularly suitable for quick initial commissioning of your drive system with subsequent testing of your projected axis model. Since steps or their sequence may vary depending on the application, refer to the corresponding application manual for detailed information.

Information

Always perform the steps described below in the specified order!

Some parameters are interdependent and do not become accessible to you until you have first configured certain settings. Follow the steps in the specified sequence so that you can finish the parameterization completely.

14.1 Initiating the project

In order to be able to configure all drive controllers and axes of your drive system using DriveControlSuite, you must record them as part of a project.

14.1.1 Projecting the drive controller and axis

Create a new project and project the first drive controller along with the accompanying axis.

Information

Make sure that you project the correct series in the *Drive controller* tab. The projected series cannot be changed afterwards.

Creating a new project

1. Start DriveControlSuite.
2. On the start screen, click *Create new project*.
 - ⇒ The new project is created and the configuration dialog for the first drive controller opens.
 - ⇒ The *Drive controller* button is active.

Projecting the drive controller

1. **Properties tab:**

Establish the relationship between your circuit diagram and the drive controller to be projected in DriveControlSuite.

 - 1.1. **Reference:**

Define the reference code (equipment code) of the drive controller.
 - 1.2. **Designation:**

Give the drive controller a unique name.
 - 1.3. **Version:**

Version your project configuration.
 - 1.4. **Description:**

If necessary, save additional supporting information (e.g., the change history).
2. **Drive controller tab:**

Select the series, device type and firmware version of the drive controller.
3. **Option modules tab, Safety module:**

If the drive controller is part of a safety circuit, select the corresponding safety module.
4. **Device control tab:**

Project the basic control of the drive controller.

 - 4.1. **Device control:**

Select the device control that defines the underlying activation signals of the drive controller.
 - 4.2. **Rx process data, Tx process data:**

If you use a fieldbus to control the drive controller, select the corresponding receive and transmit process data.

Projecting the axis

1. Click Axis A.
2. Properties tab:
Establish the relationship between your circuit diagram and the axis to be projected in DriveControlSuite.
 - 2.1. Reference:
Define the reference code (equipment code) of the axis.
 - 2.2. Designation:
Give the axis a unique name.
 - 2.3. Version:
Version your project configuration.
 - 2.4. Description:
If necessary, save additional supporting information (e.g., the change history).
3. Application tab:
Select the desired controller-based or drive-based application.
4. Motor tab:
Select the type of motor you operate with this axis. If you are working with motors from third-party suppliers, enter the accompanying motor data later.
5. Repeat the steps for axis B (only for double-axis controllers).
6. Confirm with OK.

14.1.2 Configuring safety technology

If the drive controller is part of a safety circuit, you must configure the safety technology in accordance with the commissioning steps outlined in the corresponding manual in the next step (siehe [Detailed information \[▶ 402\]](#)).

14.1.3 Creating other modules and drive controllers

We recommend sorting all drive controllers of your project in DriveControlSuite either functionally by groups and combining a group under a module, or organizing several drive controllers in corresponding modules based on their distribution to different control cabinets.

1. Select your P1 project in the project tree > Context menu *Create new module*.
⇒ Your M2 module is created in the project tree.
2. Select your M2 module in the project tree > Context menu *Create new drive controller*.
⇒ Your T2 drive controller is created in the project tree.
3. Mark your T2 drive controller in the project tree.
4. Change to the project menu and click *Project configuration*.
5. Project the drive controller and specify the newly created module.
6. Repeat the steps for all other drive controllers and modules of your project.

14.1.4 Projecting the module

Give your module a unique name, enter the reference code and, as an option, store additional information like the version and change history of the module.

1. Select the module in the project tree and click on **Project configuration** in the project menu.
 - ⇒ The configuration dialog for the module opens.
2. Establish the relationship between your circuit diagram and the module in DriveControlSuite.
 - 2.1. **Reference:**
Define the reference code (equipment code) of the module.
 - 2.2. **Designation:**
Give the module a unique name.
 - 2.3. **Version:**
Version the module.
 - 2.4. **Description:**
If necessary, save additional supporting information (e.g., the change history).
3. Confirm with **OK**.

14.1.5 Projecting the project

Give your project a unique name, enter the reference code and, as an option, store additional information like the version and change history of the project.

1. Select the project in the project tree and click on **Project configuration** in the project menu.
 - ⇒ The configuration dialog for the project opens.
2. Establish the relationship between your circuit diagram and the project in DriveControlSuite.
 - 2.1. **Reference:**
Define the reference code (equipment code) of the project.
 - 2.2. **Designation:**
Give the project a unique name.
 - 2.3. **Version:**
Version the project.
 - 2.4. **Description:**
If necessary, save additional supporting information (e.g., the change history).
3. Confirm with **OK**.

14.2 Mapping the mechanical axis model

To be able to put your real drive train with one or more drive controllers into operation, you must map your complete mechanical environment in DriveControlSuite.

14.2.1 Parameterizing the motor

You have projected one of the following motors:

Synchronous servo motor with EnDat 2.2 digital encoder or EnDat 3 (with optional brake)

By projecting the corresponding motor, limiting values for currents and torques as well as associated temperature data are automatically transferred to the respective parameters of the individual wizards. All additional data on the brake and encoder is transferred at the same time.

Lean motor without encoder (with optional brake)

By projecting the corresponding motor, limiting values for currents and torques as well as associated temperature data are automatically transferred to the respective parameters of the individual wizards. You only have to parameterize the cable length in use. Even the brake purging and engaging times are already stored. You just have to activate the brake.

1. Select the relevant drive controller in the project tree and click on the desired projected axis in the Project menu > Wizard area.
2. Select the Motor wizard.
3. B101 Cable length:
Select the cable length of the power cable in use.
4. Repeat the steps for the 2nd axis (only for double-axis controllers).

Then activate the brake.

1. Select the relevant drive controller in the project tree and click on the first projected axis in the Project menu > Wizard area.
2. Select the Brake wizard.
3. F00 Brake:
Select 1: Active.
4. Repeat the steps for the 2nd axis (only for double-axis controllers).

Motor protection

The drive controller has an i^2t model of the motor, a computational model for thermal monitoring of the motor. To activate it and set up the protective function, configure the following settings (deviating from the presets): U10 = 2: Warning and U11 = 1.00 s. This model can be used instead of or in addition to motor temperature monitoring.

14.2.2 Parameterizing the axis model

Parameterize the setup of your drive in this order:

- Define the axis model
- Scale the axis
- Parameterize the position and velocity window
- Limit the axis (optional)
 - Limit the position
 - Limit the velocity, acceleration and jerk
 - Limit the torque and force

Information

If you are using a double-axis controller with two projected axes, you must parameterize the axis model for each axis individually.

14.2.2.1 Define the axis model

1. Select the relevant drive controller in the project tree and click on the desired projected axis in the Project menu > Wizard area.
2. Select the Axis model wizard.
3. I05 Type of axis:
Define whether the axis type is rotational or translational.
 - 3.1. If you would like to configure the units of measure and the number of decimal places individually for specifying and displaying positions, velocities, accelerations and jerk, select 0: User defined, rotational or 1: User defined, translational.
 - 3.2. If the units of measure and the number of decimal places for specifying and displaying positions, velocities, accelerations and jerk are to be fixed, select 2: Rotational or 3: Translational.
4. B26 Motor encoder:
Define the interface to which the motor encoder is connected.
5. I02 Position encoder (optional):
Define the interface to which the position encoder is connected.
6. I00 Position range:
Define whether the travel range of the axis is limited or endless (modulo).
7. If you select I00 = 1: Endless, parameterize a revolution length when you scale the axis.

Information

When you parameterize I05 Type of axis, you can either use selection 0: User defined, rotational or 1: User defined, translational to configure units of measure and the number of decimal places for the axis model individually or use selections 2: Rotational and 3: Translational to revert to preset values.

Selection 0: User defined, rotational and selection 1: User defined, translational let you configure the unit of measure (I09) and the decimal places (I06) individually. Velocity, acceleration and jerk are represented as the derivative of the unit of measure with respect to time.

Selection 2: Rotational sets the following units of measure for the axis model: position in $^{\circ}$, velocity in rpm, acceleration in rad/s^2 , jerk in rad/s^3 .

Selection 3: Translational sets the following units of measure for the axis model: position in mm, velocity in m/s, acceleration in m/s^2 , jerk in m/s^3 .

Information

If you do not parameterize it differently for I02 Position encoder, B26 Motor encoder is used for position control as standard.

14.2.2.2 Scale the axis

1. Select the relevant drive controller in the project tree and click on the desired projected axis in the Project menu > Wizard area.
2. Select the Axis model wizard > Axis: Scaling.
3. Scale the axis by configuring the overall gear ratio between the motor and output.
To simplify this scaling for you, you are provided with the scaling calculator Conversion of positions, velocities, accelerations, torque/force, which calculates the effects of changed motion variables on the entire system.
4. I01 Circular length:
If you have selected 1: Endless for I00 Position range, enter the revolution length.
5. I06 Decimal places position (optional):
If you have selected 0: User defined, rotational or 1: User defined, translational for I05 Type of axis, define the desired number of decimal places.
6. I09 Measure unit (optional):
If you have selected 0: User defined, rotational or 1: User defined, translational for I05 Type of axis, define the desired unit of measure.
7. Application-dependent parameter:
Use the polarity to specify the direction of interpretation between the axis movement and motor movement.

Information

A change to parameter I06 moves the decimal separator for all axis-specific position values! Ideally, define I06 before parameterizing other position values and then check them.

If the axis receives set value specifications from a controller or follows the master values of a master, the resolution of position values directly impacts the smooth operation of the axis. Therefore, you should define a sufficient number of decimal places appropriate for your application.

Information

Parameter I297 Maximum speed position encoder must be parameterized according to your application case. If I297 is set too low, the permitted maximum speed is exceeded even at normal operating speeds. On the other hand, if I297 is set too high, measuring errors of the encoder can be overlooked.

I297 depends on the following parameters: I05 Type of axis, I06 Decimal places position, I09 Measure unit as well as I07 Distance factor numerator position and I08 Distance factor denominator position or A585 Feed constant for CiA 402. If you have made changes to one of the parameters listed, select I297 accordingly as well.

14.2.2.3 Parameterize the position and velocity window

Enter position limits and velocity zones for set values. To do so, parameterize boundary values for reaching a position or velocity.

1. Select the **Axis model wizard > Window position, velocity**.
2. **C40 Velocity window:**
Parameterize a tolerance window for velocity tests.
3. **I22 Target window:**
Parameterize a tolerance window for position tests.
4. **I87 Actual position in window time:**
Parameterize how long a drive must stay in the specified position window before a corresponding status message is output.
5. **Application-dependent parameter:**
Parameterize a tolerance window for lag tests.

14.2.2.4 Limiting the axis

As an option, you can limit the maximum permitted motion variables of position, velocity, acceleration, jerk and torque/force according to your application.

Information

To simplify the scaling and limiting of the axis, the **Axis model wizard > Axis: Scaling** provides you with the **Conversion of position, velocities, accelerations, torque/force** scaling calculator, which calculates the effects of changed motion variables on the entire system. You can use the scaling calculator to enter values for motion variables of the motor, gear unit output and axis in order to convert the values to all other locations in the axis model.

Limiting the position

To secure the travel range of the axis, you have the option to limit the permitted positions using a software or hardware limit switch.

1. Select the relevant drive controller in the project tree and click on the desired projected axis in the **Project menu > Wizard area**.
2. Select the **Axis model wizard > Limit: Position**.
3. **I101 Source positive /limit switch, I102 Source negative /limit switch:**
To limit the travel range of the axis via hardware limit switches, select the source of the digital signal that is used to evaluate a limit switch at the positive or negative end of the travel range.
 - 3.1. If a fieldbus is the source, select **2: Parameter**.
 - 3.2. If a digital input (direct or inverted) acts as the source, select the corresponding input.
4. **I50 Software stop positive, I51 Software stop negative:**
To limit the travel range of the axis via software limit switches, define the largest or smallest permitted position for software position limiting.

Limiting velocity, acceleration, jerk

As an option, you can limit the motion variables of velocity, acceleration and jerk and define the quick stop deceleration according to your application. The default values are designed for slow velocities without gear units.

1. Select the **Motor wizard**.
2. **B83 v-max motor**:
Determine the maximum permitted velocity of the motor.
3. Select the **Axis model wizard** > **Axis: Scaling**.
4. **Conversion of positions, velocities, accelerations, torque/force area**:
Use the scaling calculator to determine the maximum permitted velocity of the output using the maximum permitted velocity of the motor.
5. Select the **Axis model wizard** > **Limit: Velocity, acceleration, jerk**.
6. **I10 Maximal speed**:
Define the maximum permitted velocity for the output.
7. **I11 Maximal acceleration**:
Define the maximum permitted acceleration for the output.
8. **I16 Maximal jerk**:
Define the maximum permitted jerk for the output.
9. **I17 Quickstop deceleration**:
Define the desired quick stop deceleration for the output.
10. Repeat the steps for axis B (only for double-axis controllers).

Limiting torque/force

As an option, you can limit the torque/force according to your application. The default values take into account the rated operation together with the overload reserves.

1. Select the **Axis model wizard** > **Limit: Torque/force**.
2. **C03 Maximum positive torque/force, C05 Maximum negative torque/force**:
Define the maximum permitted set torque/maximum permitted set force.
3. **C08 Maximum torque/force for quick stop**:
Define the maximum permitted set torque/maximum permitted set force in case of a quick stop and in case of drive-controlled emergency stop SS1, SS1 and SS2.

14.3 Transmitting and saving a configuration

In order to transmit and save the configuration to one or more drive controllers, you must connect your PC and the drive controllers over the network.

WARNING!

Injury to persons and material damage due to axis movement!

If there is an online connection between DriveControlSuite and the drive controller, changes to the configuration can lead to unexpected axis movements.

- Only change the configuration if you have visual contact with the axis.
- Make sure that no people or objects are within the travel range.
- For access via remote maintenance, there must be a communication link between you and a person on site with eye contact to the axis.

Information

During the search, all drive controllers within the broadcast domain are found via IPv4 limited broadcast.

Requirements for finding a drive controller in the network:

- Network supports IPv4 limited broadcast
- All drive controllers and the PC are in the same subnet (broadcast domain)

14.3.1 Transmitting the configuration

The steps for transmitting the configuration vary depending on the safety technology.

Drive controller without SX6 option (extended safety technology)

- ✓ The drive controllers are switched on and can be found in the network.
- 1. In the project tree, select the module under which you have recorded your drive controller and click **Online connection** in the project menu.
 - ⇒ The **Add connection** dialog box opens. All drive controllers found via IPv4 limited broadcast are displayed.
- 2. **Direct connection** tab, **IP address** column:
Activate the IP addresses in question and confirm your selection with **OK**.
 - ⇒ The **Online functions** window opens. All drive controllers connected through the selected IP addresses are displayed.
- 3. Select the module and the drive controller to which you would like to transfer the configuration. Change the selection of transmission type from **Read** to **Send**.
- 4. Change the selection **Create new drive controller**:
Select the configuration that you would like to transfer to the drive controller.
- 5. Repeat steps 3 and 4 for all other drive controllers to which you would like to transfer your configuration.
- 6. **Online** tab:
Click **Establish online connections**.
 - ⇒ The configurations are transferred to the drive controllers.

Drive controller with SX6 option (extended safety technology)

- ✓ The drive controllers are switched on and can be found in the network.
- 1. In the project tree, select the module under which you have recorded your drive controller and click **Online connection** in the project menu.
 - ⇒ The **Add connection** dialog box opens. All drive controllers found via IPv4 limited broadcast are displayed.
- 2. **Direct connection** tab, **IP address** column:
Activate the IP addresses in question and confirm your selection with **OK**.
 - ⇒ The **Online functions** window opens. All drive controllers connected through the selected IP addresses are displayed.
- 3. Select the module and the drive controller to which you would like to transfer the configuration. Change the selection of transmission type from **Read** to **Send**.
- 4. Change the selection **Create new drive controller**:
Select the configuration that you would like to transfer to the drive controller.
- 5. Repeat steps 3 and 4 for all other drive controllers to which you would like to transfer your configuration.
- 6. **Online** tab:
Click **Establish online connections**.
 - ⇒ The configurations are transferred to the drive controllers.
 - ⇒ The **PASmotion Safety Configurator** configuration tool opens.
- 1. In the project administration, navigate from **PASmotion Safety Configurator** to the safety module for the drive controller and double-click to open it.
 - ⇒ The wizard for device synchronization opens.
 - ⇒ The project configuration and device configuration are checked against each other.
- 2. If the configurations match, click **Done** after device synchronization has finished.
- 3. Optional: If the configurations do not match, click **Next** after device synchronization has finished.
 - 3.1. Confirm the serial number of the safety module and click **Next**.
 - 3.2. Enter the password for the configuration on the safety module and click **Next**.
 - 3.3. Click **Download**.
 - ⇒ The project configuration is transferred to the safety module.
 - 3.4. After the successful transfer, click **Done**.
- 4. **Home page, CRC safety configuration**:
Document the checksum of the safety functions in the machine documentation.
- 5. Repeat the steps for each additional safety module in your project.
- 6. Exit **PASmotion Safety Configurator**.
 - ⇒ Transfer of the configuration is completed.

Information

If you do not know the password for the configuration on the safety module and would like to send a new safety configuration, you can delete the safety configuration on the safety module in **DriveControlSuite** using parameter **S33**.

14.3.2 Saving the configuration

- ✓ You have successfully transferred the configuration.
- 1. Online functions window, Online tab, Actions for drive controller in online operation area:
Click Save values (A00).
 - ⇒ The Save values (A00) window opens.
- 2. Select on which drive controllers you want to save the configuration.
- 3. Click Start action.
 - ⇒ The configuration is stored on the drive controllers in non-volatile memory.
- 4. Close the Save values (A00) window.

Information

For the configuration to take effect on the drive controller, a restart is required: for example, after the configuration is saved on the drive controller for the first time or when changes are made to the firmware or process data mapping.

Restarting a drive controller

- ✓ You have stored the configuration on the drive controller in non-volatile memory.
- 1. Online functions window, Online tab:
Click Restart (A09).
 - ⇒ The Restart (A09) window opens.
- 2. Select which of the connected drive controllers you want to restart.
- 3. Click Start action.
- 4. Confirm the safety note with OK.
 - ⇒ The Restart (A09) window closes.
- ⇒ The fieldbus communication and connection between DriveControlSuite and drive controllers are interrupted.
- ⇒ The selected drive controllers restart.

14.4 Testing the configuration

After you have transferred the configuration to the drive controller, first check your projected axis model and the parameterized electrical and mechanical data for plausibility before continuing with the parameterization.

Information

Make sure that the values of the control panel are compatible with your projected axis model in order to obtain useful test results that you can use to optimize your configuration for the respective axis.

The scaling calculator is available under the *Axis model wizard > Axis: Scaling* to recalculate the values for the control panel according to your projected axis model.

WARNING!

Injury to persons and material damage due to axis movement!

When you activate the control panel, DriveControlSuite gives you sole control of the motions of the axis. If you are using a controller, it no longer monitors the axis movements after the control panel is activated. The controller cannot intervene to prevent collisions. The controller takes over control again when the control panel is deactivated, which can cause unexpected axis movements.

- Do not switch to other windows when the control panel is active.
- Only use the control panel if you have visual contact with the axis.
- Make sure that no people or objects are within the travel range.
- For access via remote maintenance, there must be a communication link between you and a person on site with eye contact to the axis.

Testing the configuration using the jog control panel

- ✓ There is an online connection between DriveControlSuite and the drive controller.
 - ✓ You have successfully stored the configuration on the drive controller.
 - ✓ No safety function is active.
1. Select the relevant drive controller in the project tree and click on the desired projected axis in the Project menu > Wizard area.
 2. Select the Jog control panel wizard.
 3. Click Control panel on and then Enable.
 - ⇒ The axis is monitored via the active control panel.
 4. Check the default values of the control panel and adjust them to your projected axis model if necessary.
 5. To test the configuration of your projected axis for direction of motion, velocity, etc., move the axis gradually using the Jog+, Jog-, Jog step+ and Jog step- buttons.
 6. Use your test results to optimize your configuration as necessary.
 7. To deactivate the control panel, click on Control panel off.

Information

Jog+ and Jog- cause a continual manual movement in the positive or negative direction. Jog step+ and Jog step- move the axis relative to the current actual position by the increment specified in I14.

Jog+ and Jog- have a higher priority than Jog step+ and Jog step-.

14.5 Preparing for a case of service

Back up your configuration to an SD card after completing commissioning in order to allow transfer of the configuration to the replacement drive controller in case of service. For information on the SD cards that can be used, see [X700: SD slot](#) [▶ 130].

For drive controllers with the SX6 safety module, affix a sticker with the CRC checksum (S09[2]) to the front of the device to avoid confusion during installation or replacement. In addition, document the CRC checksum in your machine documentation.

14.6 Testing the safety configuration

Check the interfaces, limit values and reaction times of the safety functions. Document the test results using the scope functions of DriveControlSuite, for example. Detailed information on the safety functions can be found in the manual for the safety module.

Information

With extended safety technology using the SX6 safety module, changes to the safety configuration result in a change to the CRC checksum. After completing the tests, if necessary, update the CRC checksum of the safety functions that was documented during commissioning.

14.7 Safety technology for series machines

In the case of series machines, check the CRC checksum of the safety functions (S09[2]) instead of checking the individual safety functions. A prerequisite for the CRC checksum is extended safety technology through the SX6 safety module.

Check whether the CRC checksum of the safety functions stored in the machine documentation matches the checksum in the drive controller:

- Manual comparison: The checksum is shown on the drive controller display or in DriveControlSuite.
- Automated comparison: Monitor the checksum of the safety functions in the control system. If the checksum does not meet expectations, do not operate the machine.

15 Communication

The following options are available for communicating with the SC6 drive controller:

- Communication between drive controller and controller
 - Fieldbus
 - Terminals
- Communication between drive controller and PC for commissioning, optimization and diagnostics
 - Direct connection
 - Fieldbus

The DriveControlSuite project configuration and commissioning software installed on the PC is able to handle multiple direct connections simultaneously.

15.1 Direct connection

A direct connection is a network connection in which all nodes are in the same network.

In its simplest form, a direct connection is a point-to-point cable connection between the network interface of the PC where DriveControlSuite is installed and the network interface of the drive controller. Switches or routers can also be used in place of a simple network cable.

The IP address required for direct connection is either assigned automatically by DriveControlSuite or using DHCP, or it is specified manually.

Requirements

Type of direct connection	Requirements
Automatic	The A166 parameter in DriveControlSuite must be set to 2: DHCP + DS6 for the direct connection to be established automatically. In addition, the network adapter used on the PC side should be set to "Obtain IP address automatically".
Manual	If the IP address of the drive controller was specified manually, the socket of the gateway device and the network connection of the PC must have IP addresses from the same subnet.

Tab. 168: Requirements for a direct connection

Observe the requirements for communication (see [Communication requirements \[▶ 368\]](#)) and the information on establishing a connection (see [Establishing a connection \[▶ 369\]](#)).

Virtual machines

If you want to connect STOBER drive controllers to DriveControlSuite from a virtual machine, pay attention to the configuration information (see [Configuring virtual machines \[▶ 375\]](#)).

15.1.1 Starting a drive controller in emergency operation

If you cannot establish a network connection to the drive controller via DriveControlSuite, DriveControlSuite cannot assign a network address to the drive controller or the drive controller is not displayed in DriveControlSuite, you can use the S1 operating button or an empty SD card to start the drive controller in emergency operation.

Starting with S1 operating button

If the drive controller has a fixed IP address that does not match the subnet of the PC, press and hold the operating button when switching on the 24 V supply until all 3 LEDs go out (approx. 3 s after switching on). The IP address is then assigned either automatically by DriveControlSuite or via DHCP, regardless of the setting in A166. In this case, the operating button acts as an override.

A drive controller hardware version ≥ 50 and firmware version V 6.5-L or later (nameplate: HW ≥ 50 ; parameter: E52[1] ≥ 50) are required for the S1 operating button. The operating button is located on the top of the drive controller.

Starting with an SD card

If an SD card is inserted when the drive controller is started, it is started from this card. Any existing configuration in the internal memory of the drive controller is ignored. If there is no configuration on the SD card or if it is invalid, the drive controller starts in emergency operation. For drive controllers with firmware V 6.5-A or higher, the fixed IP address 192.168.3.2 and fixed subnet mask 255.255.255.0 are used for service interface X9 in emergency operation.

Reading out the internal configuration

If you want to read out the internal configuration, save a file with the information on the desired IP address, subnet mask and address assignment to the SD card. The drive controller adopts these settings after reading the internal configuration for interface X9. You can then establish a manual direct connection to the drive controller.

1. Create a text file with the file name ParaWr.cmd and the following content:

```
A164 = "192.168.3.2"
```

```
A165 = "255.255.255.0"
```

```
A166 = "0"
```

Make sure that each line, including the last, ends with a line break (CR LF).

2. Create the \command directory on the SD card.
3. Save the text file to the newly created directory on the SD card.
4. Adjust the IP address and subnet mask of your PC.
5. Establish a manual direct connection to the drive controller in DriveControlSuite.

15.2 Fieldbus

For detailed information about the fieldbus connection, refer to the corresponding manual (see [Detailed information \[▶ 402\]](#)).

16 Optimizing the control cascade

The following chapters describe the structure of the control cascade first as a basis, as well as the general procedure for optimizing it. Then, you learn how you can check your control cascade based on a few parameters for nearly 80% of all applications and, if necessary, optimize the pre-set values for your specific application case. Special cases are addressed at the end of the chapter.

16.1 Structure of the control cascade

The control cascade triggers the appropriate electrical actuation of the motor for a requested movement. The structure of the control cascade depends on the control mode set in B20.

The following graphic shows the control cascade using a motor with encoder in vector-controlled operation as an example. The representation of the control cascade follows the signal course: Position controller > Velocity controller > Current controller.

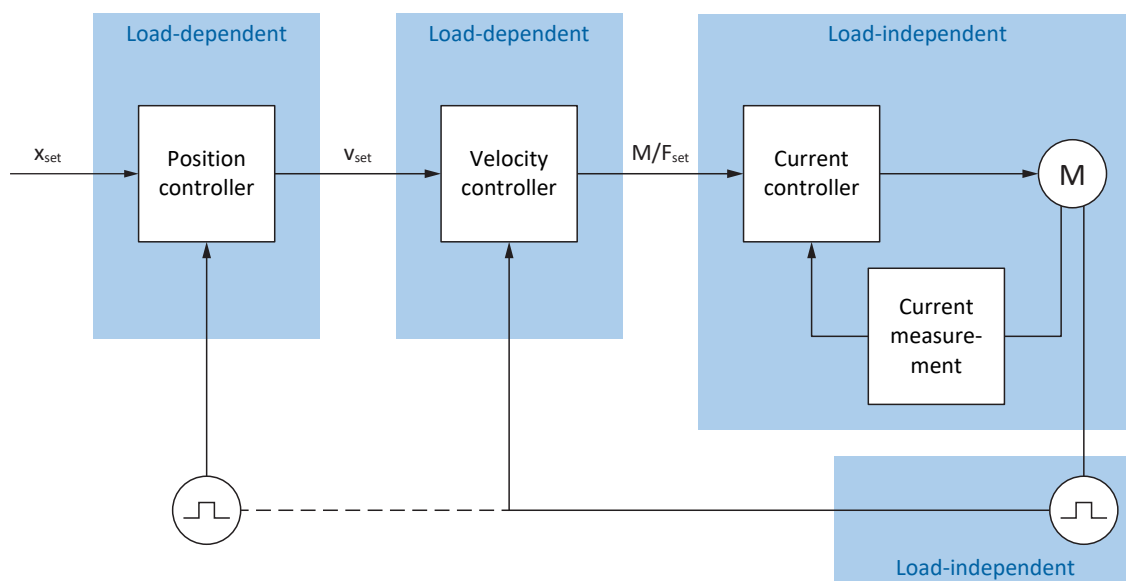

Fig. 35: Structure of the control cascade

Position controller

The position controller is a P controller (proportional controller) with feedforward control. The settings for the position controller are load-dependent.

The following applications use position control:

- Drive Based applications for the following commands:
 - MC_MoveAbsolute
 - MC_MoveRelative
 - MC_MoveAdditive
 - MC_MoveVelocity
- CiA 402 application in the following operating modes:
 - Cyclic synchronous position mode
 - Profile position mode
- PROFIdrive application in the following application classes:
 - Application class 3 (AC3)
- Application-independent with position control in jog mode

Velocity controller

The velocity controller is a PI controller (proportional-integral controller). The settings for the velocity controller are load-dependent. Velocity control is always required for vector control.

Current controller

The current controller is a PID controller (proportional-integral-differential controller). The settings for the current controller are load-independent. The current controller is always required for vector control.

16.2 General procedure

Before making changes to your control cascade, observe the following information on the general procedure for optimization.

Defining the optimization goal

First, define the goal that you want to reach through optimization:

- High dynamics
- High energy efficiency
- Positioning accuracy
- Smooth operation
- Minimum control difference
- High velocity

Some goals can only be combined under certain conditions or are mutually exclusive.

Hardware components as possible limits of optimization

An optimal drive train always consists of a coordinated system of all hardware components (gear unit, motor, encoder, drive controller and cable). Consequently, optimization depends not only on your parameter settings, but also on the hardware components used.

Drive controller presets

If you use components from STOBER, all data is transmitted to the corresponding parameters when reading out the electronic nameplate or upon selection of the motor from the motor database – eliminating the need for complex parameterization of the motor, encoder and brake. These default values are carefully selected and checked, and generally deliver good results. Only change the default values when necessary, taking the following points into consideration:

1. First, record the current behavior of your drive train with a scope image.
2. Carry out the optimization of your control cascade in the opposite order of the signal path: Current controller > velocity controller > position controller, i.e. from the motor back to the set value specification. However, do not make adjustments to the current controller if you are using components from STOBER.
3. If adjustments are necessary, only ever change one setting and then check every change with a scope image.

16.3 Example project

The optimization described in the following chapters is based on the following general conditions and settings.

Specified goal

High dynamics with the highest possible velocity, but without the system overshooting.

System components

- 6th generation drive controller
- Synchronous servo motor with absolute encoder and electronic nameplate
- DriveControlSuite commissioning software
- Load supplied to the motor

Application and device control

- Drive Based application
- Drive Based device control

16.3.1 Scope settings

For the scope image at the beginning and after each adjustment, we recommend the settings described below to be able to compare the different results with each other.

General settings

- Sampling time: 250 μ s
- Pre-trigger: 5%

Channels

Using the `Parameter` selection and the associated picklists, define the relevant parameters for the scope image.

Trigger condition

- Simple trigger
- Source: Parameter E15 v-motor-encoder
- Absolute value: Yes
- Condition: Greater
- Edge: Yes
- Comparison value: 5.0 rpm

16.3.2 Jog settings

During optimization, test each change using the Jog control panel with the following settings:

- I26 Jog control mode:
 - Optimization of the velocity controller: Select 0: Velocity control to receive pure velocity control without a higher-level position controller with the Jog+ and Jog– bit.
 - Optimization of the position controller: Select 1: Position control with the Jog step+ und Jog step– bit.
- I14 Jog step:
Define the increment.
- I12 Jog velocity:
Define the jog velocity.
- I13 Jog acceleration:
For the jog acceleration, select a value that is higher than the velocity by a factor of 10.
- I45 Jog deceleration:
For the jog deceleration, select a value that is higher than the velocity by a factor of 10.
- I18 Jog jerk:
For the jog jerk, select a value that is higher than the acceleration by a factor of 10.

16.4 Schematic sequence

The following graphic shows the schematic sequence for optimizing the control cascade. The specific steps that are required depend on the control mode. The information on optimization assumes the following control modes:

- B20 = 64: SSM - vector control for synchronous servo motors
- B20 = 2: ASM - vector control for asynchronous motors
- B20 = 32: LM - sensorless vector control for Lean motors

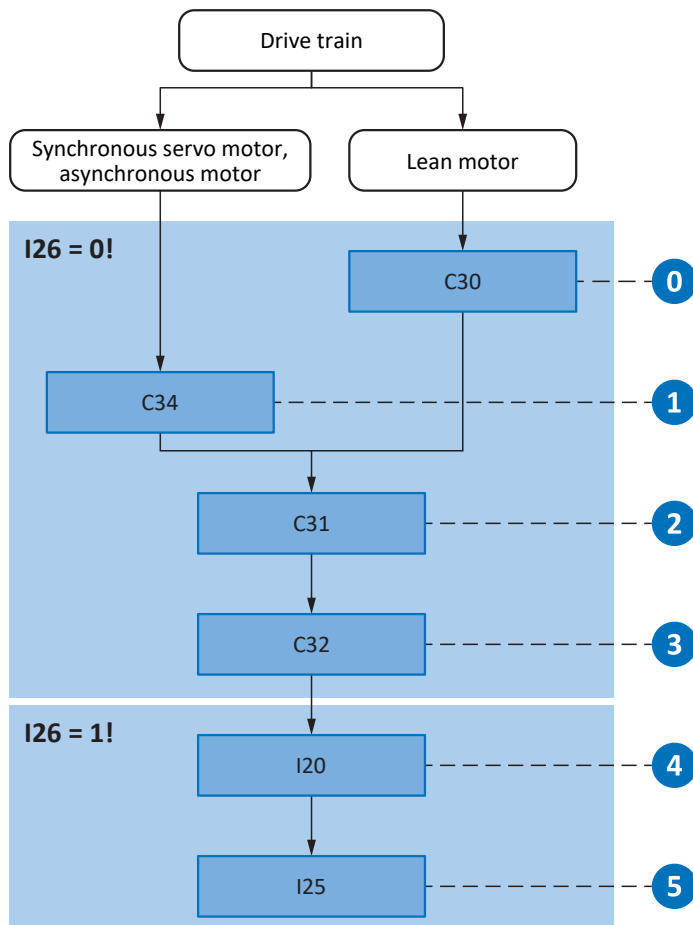

Fig. 36: Schematic sequence of optimization based on relevant parameters

- | | |
|---|---|
| 0 | Default Lean motors settings – Estimating the speed |
| 1 | Velocity controller – Defining filters for the actual velocity |
| 2 | Velocity controller – Defining the proportional coefficient |
| 3 | Velocity controller – Defining the integral coefficient |
| 4 | Position controller – Defining the proportional coefficient |
| 5 | Position controller – Defining the feedforward control of the velocity controller |

16.5 Current controller – Notes

The current controller settings depend exclusively on the motor type, not on the load or application.

Do not make any changes to the current controller if you are using components from STOBER!

The data of a STOBER motor is part of the DriveControlSuite motor database as well as the electronic nameplate. This data is transferred to the respective parameters during project configuration or when reading out the nameplate. All additional data on the brake and encoder is transferred at the same time. These settings were calibrated in the STOBER test bay and no longer need to be adjusted.

16.6 0: Default Lean motor settings – Speed estimation

When using a Lean motor of the LM series, two methods are available in DriveControlSuite for determining the speed. An observer-based process is set by default in parameter B104 that is suitable for most applications. However, the specification of the mass inertia ratio of load to motor in parameter C30 is crucial for this process.

Effects

By specifying the mass inertia ratio, the speed determination of the model adjusts to the real conditions of the machine.

Procedure

1. Work with the default value of B104 = 0: Robust.
2. In C30, enter the mass inertia ratio of load to motor based on the estimated mass inertia at the motor shaft.

Information

Only change the setting of B104 if either the mass inertia cannot be determined or the load occurring is changing rapidly.

Information

For C30, note that a deviation up to factor 2 only has a slight influence on the dynamics. If more is still needed, you can optimize the value through a comparison with the actual velocity I88 during acceleration and braking.

16.7 1: Velocity controller – Actual velocity filters

The following graphic shows the influence of the lowpass filter time constant on the velocity controller.

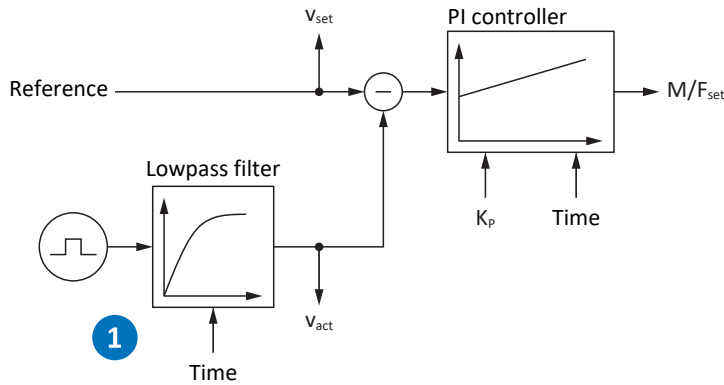

Fig. 37: Velocity controller – Filters for the actual velocity

The lowpass filter time constant for the actual velocity of the motor encoder is defined in C34.

Effects

C34 affects the smooth operation of the motor and the dynamics that can be achieved with the drive; as C34 increases, smooth operation rises and the dynamics drop.

Furthermore, C34 also has a direct influence on the maximum possible coefficient, since a large filter time also requires a large downtime.

Procedure

Select a value for C34 that is large enough to minimize the measurement and quantization noise, but is as small as possible to avoid unnecessary downtime, since this makes the system unstable and reduces dynamics.

Guide values for C34 can be found in the following table.

Encoder model	Encoder interface	Guide value C34 [ms]
EBI 135	EnDat 2.2 digital	0.4 – 0.6
EBI 1135	EnDat 2.2 digital	0.4 – 0.6
ECI 119	EnDat 2.2 digital	0.4 – 0.6
ECI 1118-G1	EnDat 2.1 digital	1.4 – 1.8
ECI 1118-G2	EnDat 2.2 digital	0.4 – 0.6
ECI 1119	EnDat 2.2 digital	0.4 – 0.6
ECI 1319	EnDat 2.1 digital	1.2 – 1.8
ECN 1113	EnDat 2.1 digital	0.8 – 1.2
ECN 1123	EnDat 2.2 digital	0.2 – 0.4
ECN 1313	EnDat 2.1 digital	0.8 – 1.2
ECN 1313	EnDat 2.1 sin/cos	0.2 – 0.8
ECN 1325	EnDat 2.2 digital	0.0 – 0.2
EDM 35	HIPERFACE DSL	0.4 – 0.6
EDS 35	HIPERFACE DSL	0.4 – 0.6
EKM 36	HIPERFACE DSL	0.4 – 0.6
EKS 36	HIPERFACE DSL	0.4 – 0.6

Encoder model	Encoder interface	Guide value C34 [ms]
EQI 1130	EnDat 2.1 digital	1.4 – 1.8
EQI 1131	EnDat 2.2 digital, EnDat 3	0.4 – 0.6
EQI 1329	EnDat 2.1 digital	1.2 – 1.8
EQI 1331	EnDat 2.1 digital	1.2 – 1.8
EQN 425	EnDat 2.1	0.8 – 1.2
EQN 425	SSI	0.8 – 1.2
EQN 1125	EnDat 2.1 digital	0.8 – 1.2
EQN 1125	EnDat 2.1 sin/cos	0.4 – 0.8
EQN 1135	EnDat 2.2 digital	0.2 – 0.4
EQN 1325	EnDat 2.1 digital	0.8 – 1.2
EQN 1325	EnDat 2.1 sin/cos	0.2 – 0.8
EQN 1337	EnDat 2.2 digital	0.0 – 0.2
Incremental; 1024 increments/revolution	HTL/TTL	2.0
Incremental; 2048 increments/revolution	HTL/TTL	1.4
Incremental; 4096 increments/revolution	HTL/TTL	0.8
Resolver; 2 poles	Analog	1.4 – 2.0
Resolver; 4 poles	Analog	1.2 – 1.8
Resolver; 6 poles	Analog	1.0 – 1.6
Resolver; 8 poles	Analog	0.8 – 1.4

Tab. 169: Guide values for C34

In Lean motors, the value is automatically taken from the drive controller firmware during the initial coupling of the motor and drive controller (prerequisite: B100 ≠ 0: User defined).

Scope image

Requirements:

- I26 = 0: Velocity control
- C34 = Guide value or value taken from firmware

Parameter for the scope image:

- E06 V-reference motor
- E15 v-motor-encoder

16.8 2: Velocity controller – Proportional coefficient

The following graphic shows the influence of the proportional coefficient on the velocity controller.

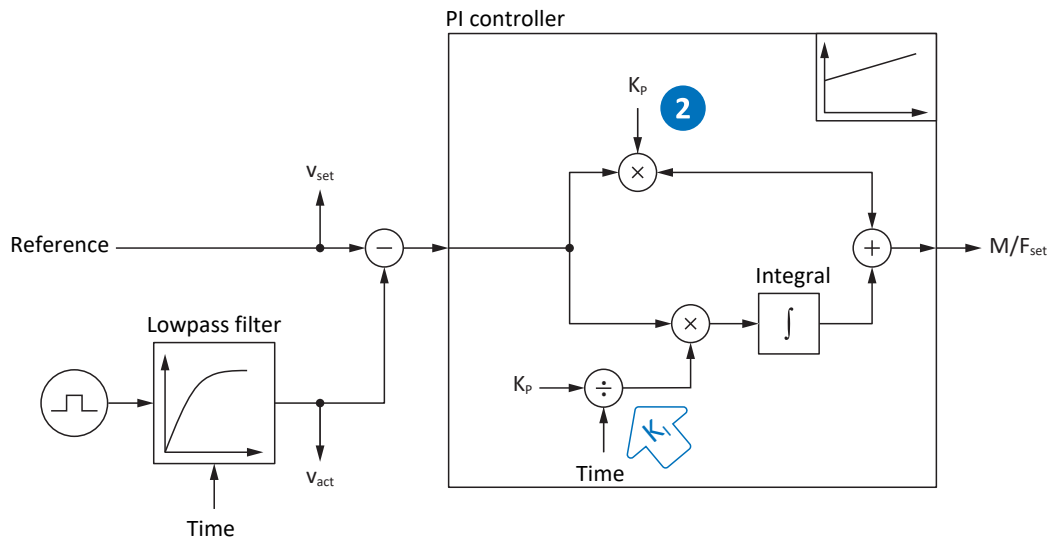

Fig. 38: Velocity controller – Proportional coefficient

The proportional coefficient K_p of the velocity controller can be defined in C31.

Effects

An adjustment of the P-share always has an effect on the I-share as well. The reason for this is the following dependency:

The integral coefficient K_i of the velocity controller results from the proportional coefficient K_p and reset time T_i ($K_i = K_p \div T_i = C31 \times C35 \div C32$).

Procedure

1. Start with the default value for C31.
2. First, enter the value 0 ms for the reset time in C32 to deactivate the I-share initially.
3. Increase the value of C31 up to the stability limit.
4. Define the value of C31 approximately 10% below the stability limit.

Scope image

Requirements:

- I26 = 0: Velocity control
- C34 = Guide value or value taken from firmware
- C32 = 0 ms
- C31 = e.g. 10, 20, 50, 150 and 200%

Parameter for the scope image:

- E06 V-reference motor
- E15 v-motor-encoder

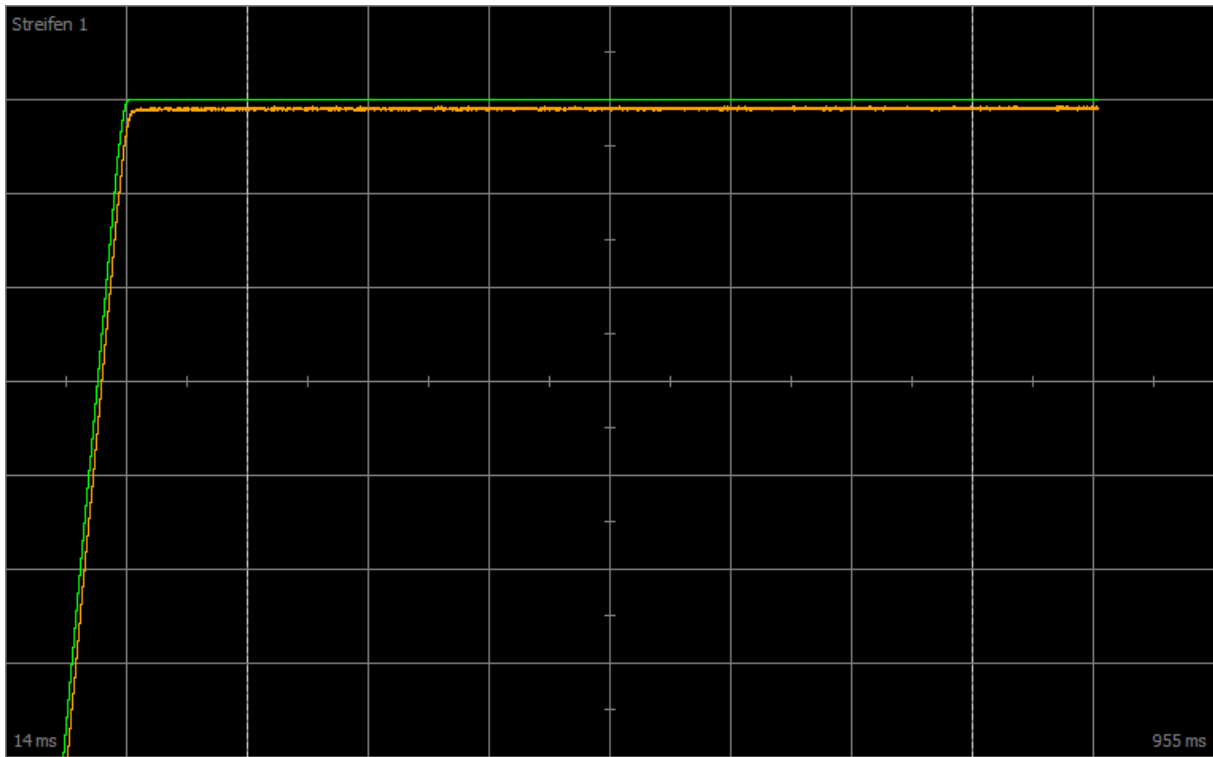

Fig. 39: Scope – Proportional coefficient of the velocity controller (C31), default value

Green Set value
Brown Actual value with default value

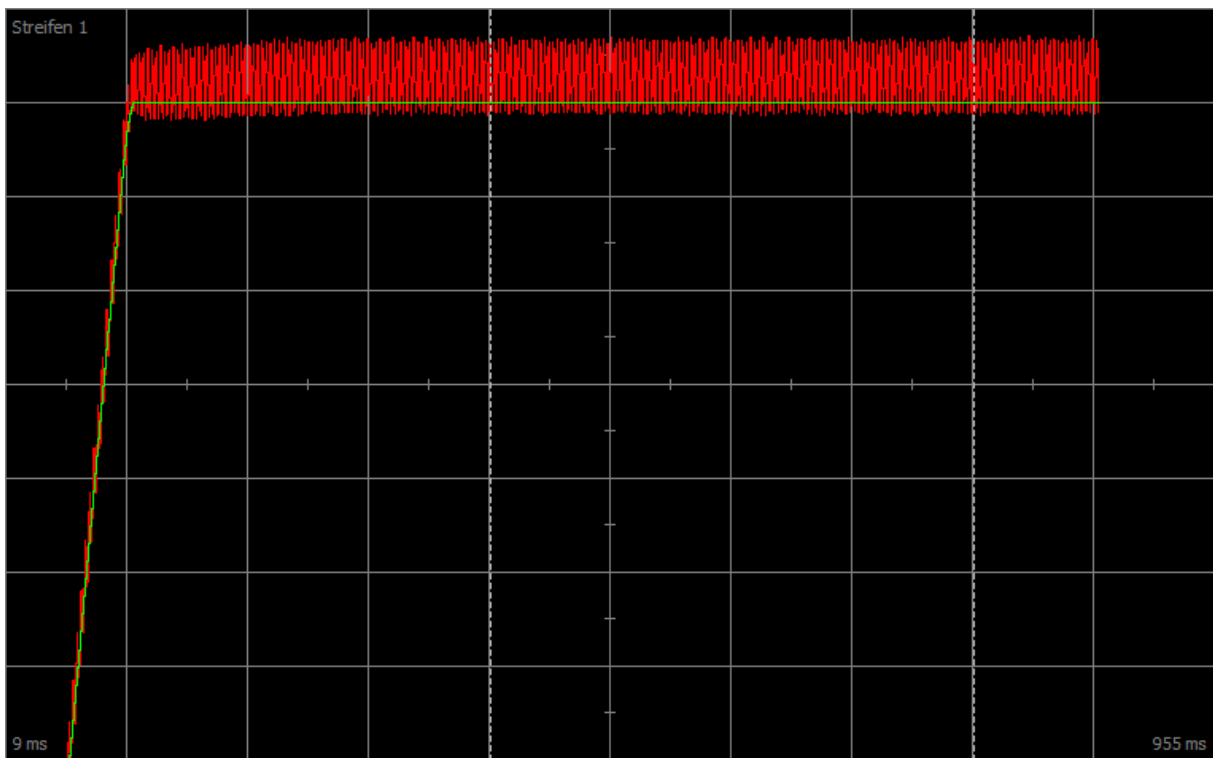

Fig. 40: Scope – Proportional coefficient of the velocity controller (C31), continuous oscillations

Green Set value
Red Actual value that exhibits continuous oscillation upon reaching the stability limit

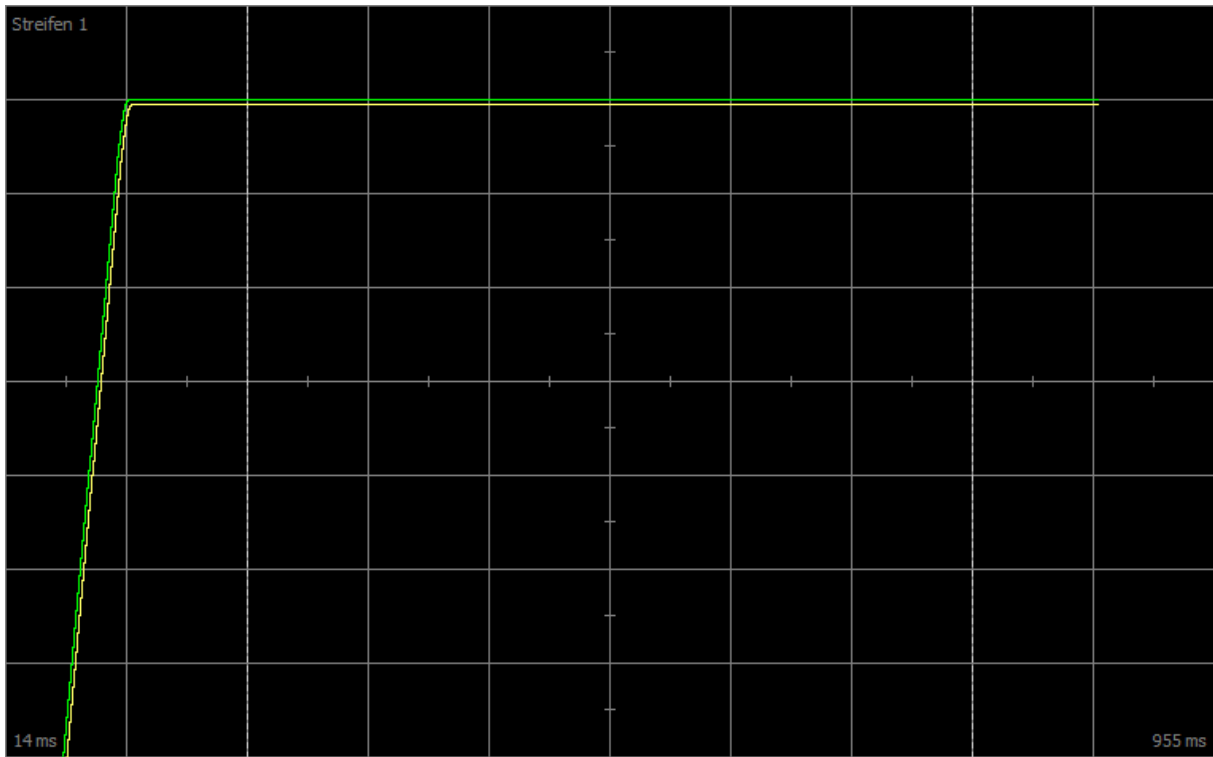

Fig. 41: Scope – Proportional coefficient of the velocity controller (C31), optimized value

Green Set value
Yellow Actual value with optimized coefficient

The zoom factor was increased for the following scope image to show overshooting based on additional values, which devolves into continuous oscillations upon reaching the stability limit.

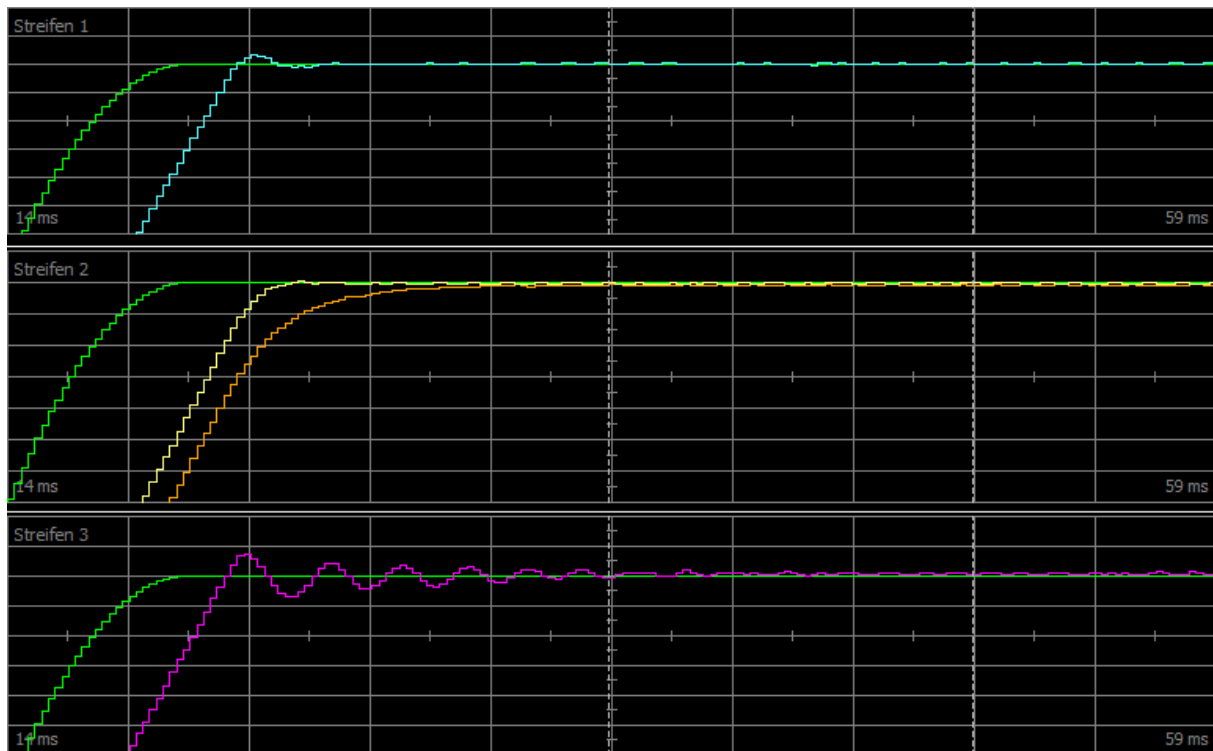

Fig. 42: Scope – Proportional coefficient of the velocity controller (C31), overshooting

- Green Set value
- Turquoise Actual value that shows brief overshooting
- Yellow Actual value with optimized coefficient
- Brown Actual value with default value
- Pink Actual value that shows long overshooting with phase-out

16.9 3: Velocity controller – Integral coefficient

The following graphic shows the influence of the integral coefficient on the velocity controller.

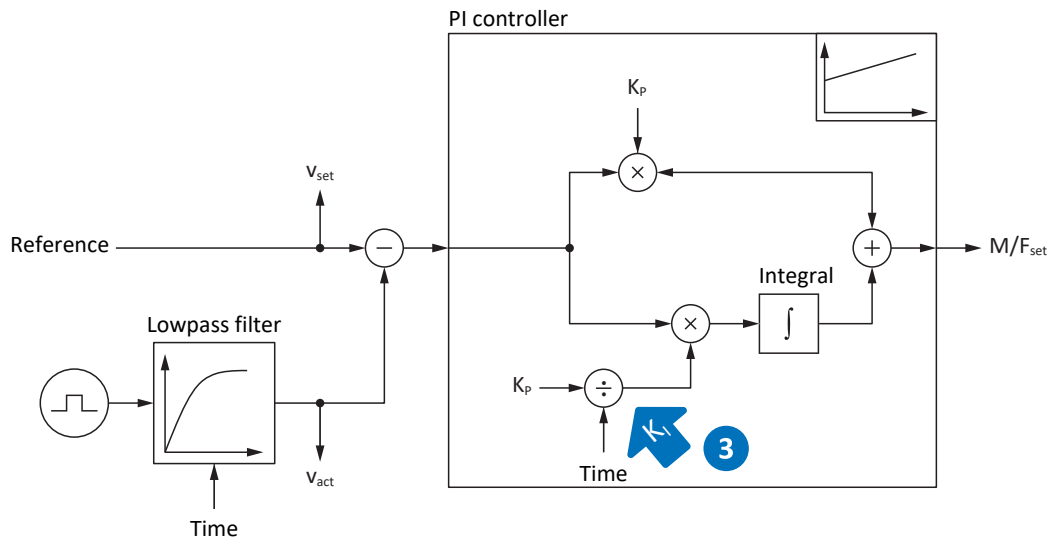

Fig. 43: Velocity controller – Integral coefficient

The integral coefficient K_i of the velocity controller results from the proportional coefficient K_p and reset time T_i ($K_i = K_p \div T_i = C31 \times C35 \div C32$).

Effects

Since the value of C31 was already optimized in the previous step, the integral coefficient is optimized in this step by adjusting the reset time in C32.

Procedure

1. Start with the default value for C32.
2. Reduce the value of C32 in order to recover more quickly. In this process, note that if $C32 \leq 1$ ms, the I-share is deactivated.
3. Increase the value of C32 up to the stability limit.
4. Define the value of C32 approximately 10% above the stability limit.

Scope image

Requirements:

- I26 = 0: Velocity control
- C34 = Guide value or value taken from firmware
- C31 = Already optimized value
- C32 = e.g. 0, 5, 10 and 50 ms

Parameter for the scope image:

- E06 V-reference motor
- E15 v-motor-encoder

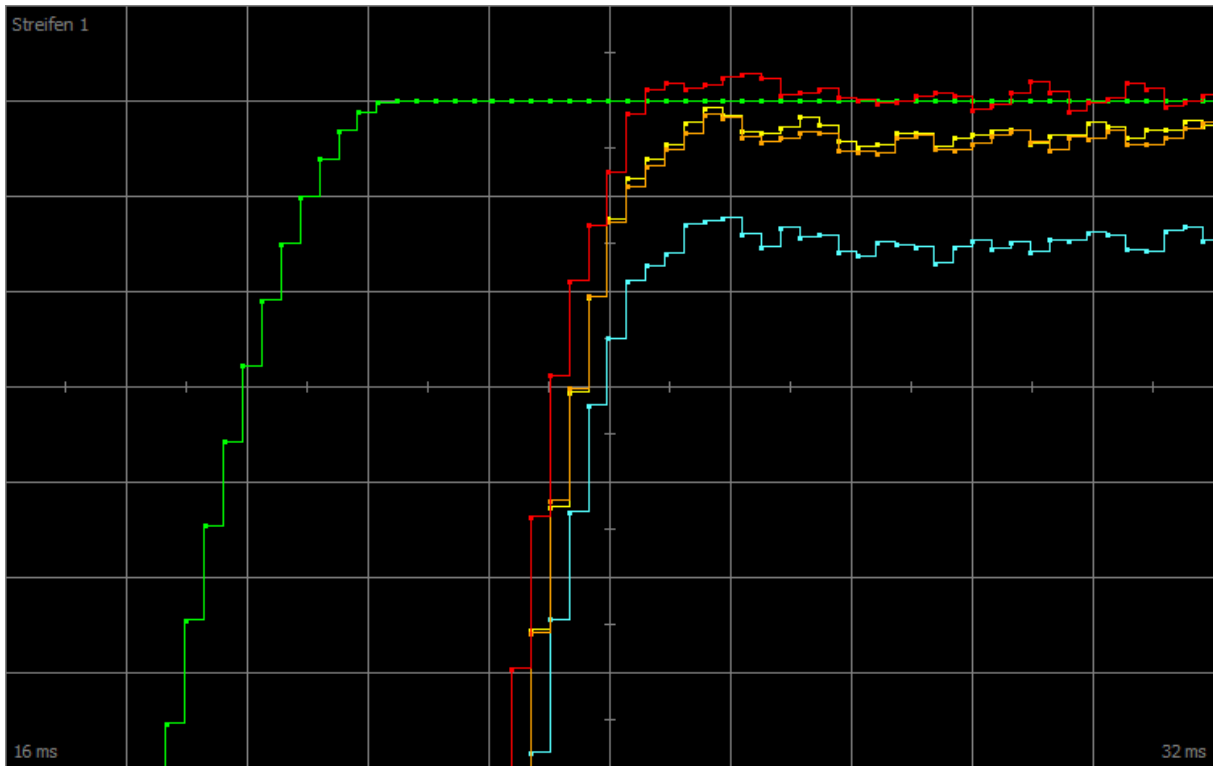

Fig. 44: Scope – Integral coefficient of the velocity controller (C32)

- Green Set value
- Red Actual value that exhibits overshooting
- Yellow Actual value with optimized coefficient
- Brown Actual value with default value
- Turquoise Actual value with deactivated coefficient (≤ 1)

16.10 Velocity controller – Summary

In summary, the following conclusions can be drawn for the optimization of the velocity controller:

- Simple encoders must be filtered more heavily.
- The maximum possible coefficient is lower with heavier filtering.
- The default coefficient is sufficient in simpler applications.
- You only require a higher coefficient in case of higher dynamics.
- Without the integral coefficient, you do not maintain any stationary accuracy, since the set velocity is not reached.

16.11 4: Position controller – Proportional coefficient

The following graphic shows the influence of the proportional coefficient on the position controller.

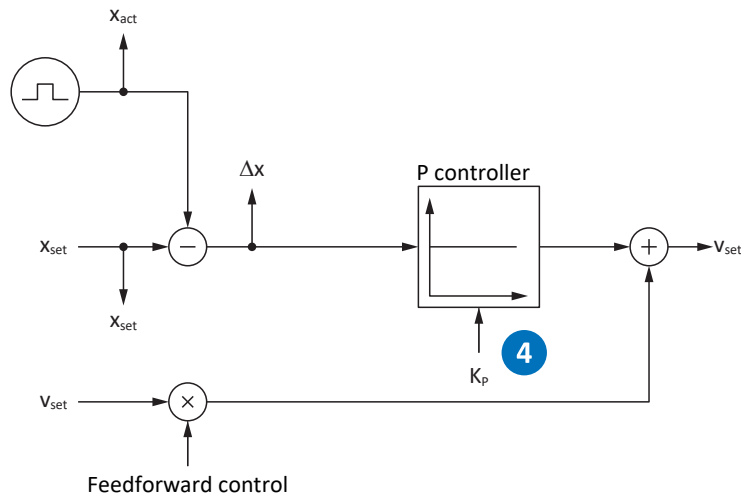

Fig. 45: Position controller – Proportional coefficient

The proportional coefficient K_p of the position controller can be defined in I20.

Effects

A higher coefficient produces a lower following error, but the system becomes more sensitive.

Procedure

1. Start with the default value for I20.
2. Increase the value of I20 up to the stability limit.
3. Define the value of I20 approximately 10% below the stability limit.

Scope image

Prerequisites:

- I26 = 1: Position control
- C34 = Guide value or value taken from firmware
- C31 = Already optimized value
- C32 = Already optimized value
- I20 = e.g. 10, 20, and 50

Parameter for the scope image:

- I96 Reference position
- I80 Current position
- I84 Following error
- E06 V-reference motor
- E15 v-motor-encoder

16.12 5: Position controller – Velocity controller feedforward control

The following graphic shows the influence of the feedforward control on the position controller.

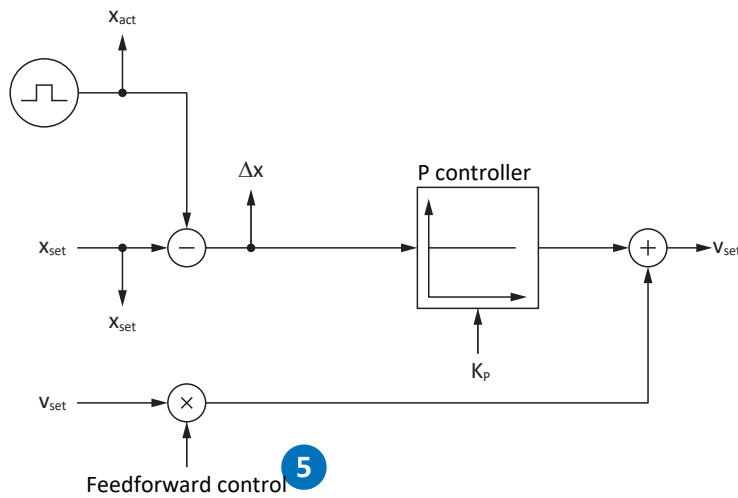

Fig. 46: Position controller – Feedforward control of the velocity controller

In case of external controller-generated or internal drive-generated feedforward control, the set velocity is also calculated in addition to the set position. In I25, you can define how much of that is directly communicated to the velocity controller.

Effects

Feedforward control reduces the load of the position controller and reduces the following error; however, stronger feedforward control makes the system more sensitive.

Procedure

1. Start with the default value of 95% for I25.
2. Reduce the value of I25 if the system is oscillating.

Scope image

Requirements:

- I26 = 1: Position control
- C34 = Guide value or value taken from firmware
- C31 = Already optimized value
- C32 = Already optimized value
- I20 = Already optimized value
- I25 = e.g. 50 and 95%

Parameter for the scope image:

- I96 Reference position
- I80 Current position
- I84 Following error
- E06 V-reference motor
- E15 v-motor-encoder

16.13 Position controller – Summary

In summary, the following conclusions can be drawn for the optimization of the position controller:

- If the velocity controller is optimized, only small adjustments are required for the position controller.

16.14 Special cases

In the cases described below, additional parameters are relevant for optimization.

16.14.1 Current controller – Motor reaches saturation

Synchronous servo motors show a saturation effect at high currents.

Effects

Upon reaching the saturation limits, a higher motor current no longer generates higher field strength and it begins to fluctuate if the current continues to increase.

Procedure

1. Carry out the action B41 Calibrate motor.
 - ⇒ The electrical data of the motor is calibrated and the coefficients of the saturation characteristic are defined (B60).
2. Activate current control tracking in B59.
 - ⇒ The controller coefficients are tracked according to the saturation characteristic of the motor.

Scope image

Parameter for the scope image:

- E166 Iq-ref
- E93 Iq

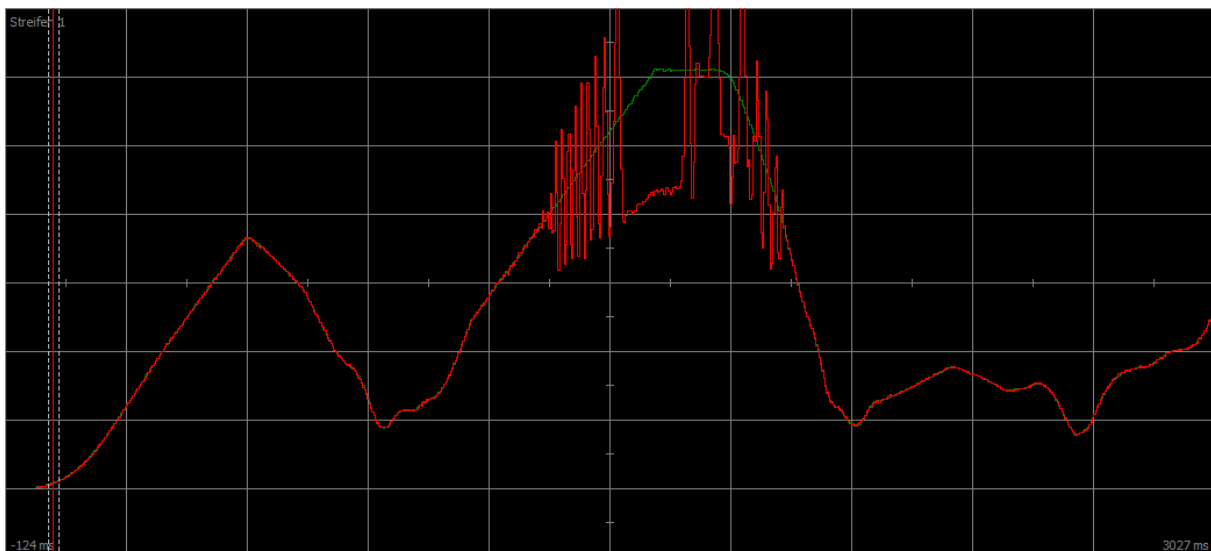

Fig. 47: Scope – Motor reaches saturation without tracking (B59)

Green	Set current
Red	Actual current

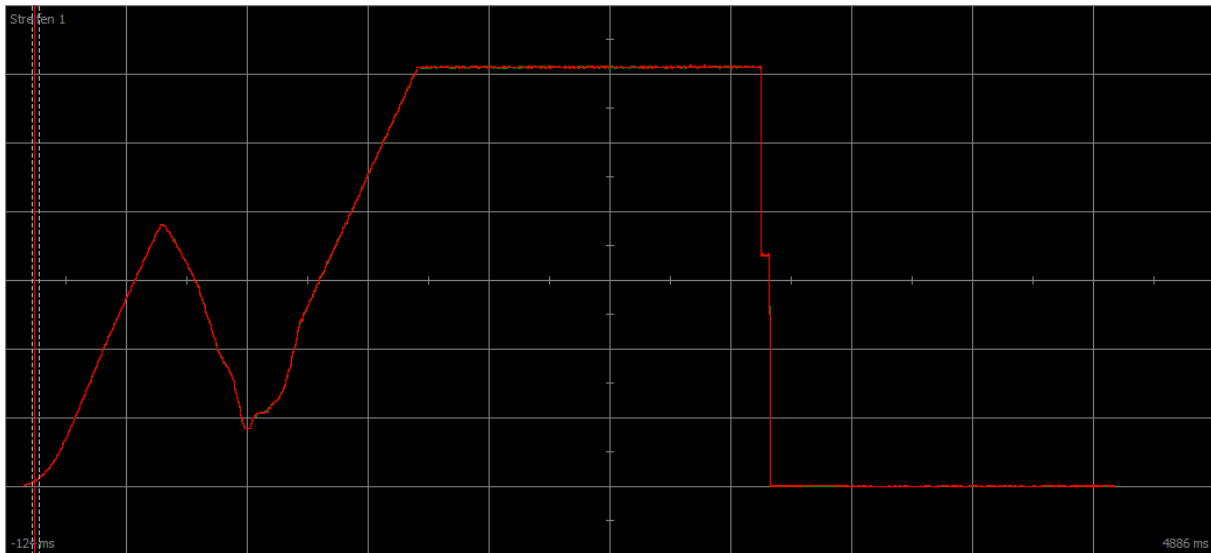

Fig. 48: Scope – Motor reaches saturation with tracking (B59)

Green Set current
Red Actual current

16.14.2 Velocity controller – High set torque

C36 Reference torque/force low pass:

If the set torque becomes very high, such as in case of maximum utilization of the drive controller, the set torque can be filtered using this parameter. The filter prevents the overshooting of the torque and thus the occurrence of overcurrents. The effect of C36 is defined using C37.

16.14.3 Position controller – Friction or play

I23 Position controller deadband:

To prevent control oscillations due to friction or play in the mechanics, the position control can be deactivated in a narrow range using this parameter.

16.14.4 Position controller – Poor resolution

C33 Lowpass reference speed:

Using this parameter, the set velocity can be smoothed if the calculation of the set or actual position is too rough due to one of the following conditions:

- In case of controller-based applications with poor or low quantization of the set value
- In case of drive-based applications with poor resolution of the master encoder

17 Brake

Without the SX6 option, the drive controller provides a functional brake test for the brake.

With the SX6 safety module, the drive controller offers safe brake management. Safe brake management fulfills the recommendations for gravity-loaded axes of DGUV Division Information Sheet 005/2021. It also fulfills the requirements for securing gravity-loaded axes from EN ISO 16090-1 from 2018.

The following chapter describes the basic brake settings using the DriveControlSuite commissioning software.

Safety module	Application	Terminal(s)
≠ SX6	Functional brake test with 1 brake	X2A and X2B
SX6	Safe brake management with 1 brake	X2A or X2B
SX6	Safe brake management with 2 brakes	X2A and X2B

Tab. 170: Application cases for the brake test and safe brake management

Without the SX6 safety module, the brake of axis A is connected to X2A and the brake of axis B to X2B.

With the SX6 safety module, brake 1 and brake 2 must be assigned to terminals X2A and X2B in PASMotion Safety Configurator via the Safe Brake Control 2-pole (SBC) safety function.

Gravity-loaded axis with brake

Information

If you use a gravity-loaded axis with a brake, always switch off the drive using a controlled stop, e.g. quick stop. This prevents the load from dropping until the brake is fully engaged.

For more detailed information on the application, refer to the corresponding manual (see [Detailed information \[► 402\]](#)).

17.1 Activating the brake

You activate the brakes in parameter F00.

1. Select the relevant drive controller in the project tree and click on the desired projected axis in the Project menu > Wizard area.
2. Select the Brake wizard.
3. F00 Brake:
Select 1: Active if you are operating the motor in a regulated control mode and if the torque is to be saved at the time that the brake engages. In this case, the saved torque is restored before releasing the brakes. Select this option for gravity-loaded axes, for example.
However, select 2: Do not save torque/force if only motor magnetization is to be restored when the brakes are released.
4. If necessary, store the release and engaging times of the brakes (see [Brake release time and brake engaging time \[► 214\]](#)).

17.2 Calibrate brake

You can calibrate the release and engaging times for brakes with unknown release and engaging times.

For more detailed information on the requirements as well as the exact procedure, see [Calibrating the brake](#) [▶ 215].

DANGER!

Risk of fatal injury due to gravity-loaded vertical axis!

During this action, the brakes are released and movement starts. The motor cannot generate any or can only generate limited torque/force during this time. This can cause a gravity-loaded vertical axis to drop.

- Make sure that safe movement in the specified travel range is possible.
- Secure the area extending beyond the travel range for the case of further lowering of the gravity-loaded vertical axis.

-
- ✓ There is an online connection between DriveControlSuite and drive controllers.
 - ✓ The drive controller is ready to switch on (E48 = 2: Ready for switch-on).
 - ✓ The brake is activated.
1. Select the relevant drive controller in the project tree and click on the desired projected axis in the Project menu > Wizard area.
 2. Select the Brake wizard > Test brake.
 3. B306 Permitted direction for actions of the brake:
Define the permitted travel direction. Calibration only takes place in one travel direction. If both directions of rotation are permitted, travel proceeds in the positive direction.
 4. B307 Standstill window brake test:
Enter the angle of rotation that the drive evaluates as a standstill.
 5. Select the Brake wizard > Calibrate brake.
 6. Click Calibrate release/engaging time for brake.
 - ⇒ Calibration of the brake is executed.
 - ⇒ The determined times are stored in F04 and F05.
 - ⇒ F96[1] indicates the progress.
 - ⇒ F96[2] outputs the result of the action.
 7. Afterwards, save the determined values in non-volatile memory (A00).

With 2 brakes, the release and engaging times of both brakes are calibrated.

17.3 Testing a functional brake

Using the brake test, check whether the brake can still apply the required holding torque or holding force.

For more information on the test and calculation of test torques, see [Brake test \[▶ 217\]](#) and [Torque calculation \[▶ 218\]](#).

DANGER!

Risk of fatal injury due to gravity-loaded vertical axis!

During this action, the closed brake is loaded with a specified test torque or a specified test force. If the test torque or test force exceeds the holding torque or holding force of the brake, this results in movement of the axis. This can cause a gravity-loaded vertical axis to drop.

- Make sure that safe movement is possible.

- ✓ There is an online connection between DriveControlSuite and drive controllers.
 - ✓ The drive controller is ready to switch on (E48 = 2: Ready for switch-on).
 - ✓ The brake is activated.
1. Select the relevant drive controller in the project tree and click on the desired projected axis in the Project menu > Wizard area.
 2. Select the Brake wizard > Test brake.
 3. B304 Positive torque/force limit for brake test:
Enter the test torque or test force that that brake must hold in case of a positive direction of rotation.
 4. B305 Negative torque/force limit for brake test:
Enter the test torque or test force that that brake must hold in case of a negative direction of rotation.
 5. E65 Current maximum positive torque/force:
Make sure that the limit in the drive controller permits the value stored in B304.
 6. E66 Current maximum negative torque/force:
Make sure that the limit in the drive controller permits the value stored in B305.
 7. B306 Permitted direction for actions of the brake:
Define the permitted travel direction. If both directions of rotation are permitted, travel first proceeds in the positive direction.
 8. B307 Standstill window brake test:
Enter the permitted standstill window.
 9. Click on Test brake.
- ⇒ The brake test is executed.
 - ⇒ B300[1] indicates the progress.
 - ⇒ B300[2] outputs the result of the action.

With 2 brakes, both brakes are tested.

17.4 Bedding in the brake

By bedding in the brake, any deposits on the friction surface are removed that can negatively influence the holding function of the brake. For more information, see [Bedding in the brake \[► 220\]](#).

DANGER!

Risk of fatal injury due to gravity-loaded vertical axis!

During this action, the brakes are released and movement starts. The motor cannot generate any or can only generate limited torque/force during this time. This can cause a gravity-loaded vertical axis to drop.

- Make sure that safe movement in the specified travel range is possible.
- Secure the area extending beyond the travel range for the case of further lowering of the gravity-loaded vertical axis.

- ✓ There is an online connection between DriveControlSuite and drive controllers.
 - ✓ The drive controller is ready to switch on (E48 = 2: Ready for switch-on).
 - ✓ The brake is activated.
1. Select the relevant drive controller in the project tree and click on the desired projected axis in the Project menu > Wizard area.
 2. Select the Brake wizard > Bend in brake.
 3. B306 Permitted direction for actions of the brake:
Define the permitted travel direction. If both directions of rotation are permitted, travel first proceeds in the positive direction.
 4. B308 Number of intervals for grind:
Enter how often the brake is to engage when rotating in one direction.
 5. B309 Number of cycles for grind:
Enter how often the drive is to bed in in any direction.
 6. Click on Bed in brake.
- ⇒ The bedding in of the brake is executed.
 - ⇒ B301[1] indicates the progress.
 - ⇒ B301[2] outputs the result of the action.

17.5 Bedding in brake 2

By bedding in the brake, any deposits on the friction surface are removed that can negatively influence the holding function of the brake. For more information, see [Bedding in the brake \[► 220\]](#).

Brake 2 is available exclusively in conjunction with the SX6 safety module.



Risk of fatal injury due to gravity-loaded vertical axis!

During this action, the brakes are released and movement starts. The motor cannot generate any or can only generate limited torque/force during this time. This can cause a gravity-loaded vertical axis to drop.

- Make sure that safe movement in the specified travel range is possible.
- Secure the area extending beyond the travel range for the case of further lowering of the gravity-loaded vertical axis.

-
- ✓ There is an online connection between DriveControlSuite and drive controllers.
 - ✓ The drive controller is ready to switch on (E48 = 2: Ready for switch-on).
 - ✓ Brake 2 is activated.
1. Select the relevant drive controller in the project tree and click on the desired projected axis in the Project menu > Wizard area.
 2. Select the Brake wizard > Bend in brake 2.
 3. B306 Permitted direction for actions of the brake:
Define the permitted travel direction. If both directions of rotation are permitted, travel first proceeds in the positive direction.
 4. B308 Number of intervals for grind:
Enter how often the brake is to engage when rotating in one direction.
 5. B309 Number of cycles for grind:
Enter how often the drive is to bed in in any direction.
 6. Click on Bed in brake 2.
- ⇒ The bedding in of the brake is executed.
 - ⇒ B302[1] indicates the progress.
 - ⇒ B302[2] outputs the result of the action.

17.6 More about the brake?

The following chapters summarize the important terms and settings.

17.6.1 Direct and indirect brake connection

The SC6 drive controller provides the option of directly connecting 24 V_{DC} brakes with a current draw of up to 2.5 A. Brakes with a different supply voltage or higher current draw can be connected indirectly, e.g. through a contactor.

Drive controller without SX6 option

You have the following options for connection:

- Directly to X2A, X2B (with or without monitoring)
- Indirectly to X2A, X2B (with or without monitoring)

Without the SX6 safety module, the brake of axis A is connected to X2A and the brake of axis B to X2B.

You can monitor the brakes using parameter F105. A drive controller hardware version ≥ 100 and firmware version V 6.5-L or later (nameplate: HW ≥ 100 ; parameter: E52[1] ≥ 100) are the prerequisites for monitoring.

Drive controller with SX6 option

You have the following options for connection:

- Directly to X2A, X2B (with monitoring)
- Indirectly to X2A, X2B (with or without monitoring)

With the SX6 safety module, brake 1 and brake 2 must be assigned to terminals X2A and X2B in PASmotion Safety Configurator via the Safe Brake Control 2-pole (SBC) safety function.

17.6.2 Release override

You have the option of releasing the brakes using an override function when the power unit is deactivated. The release override is only available with internal brake control. You define the release override in parameter F06 (signal: F07).

Please note that the drive cannot be enabled when the release override is active.

When the drive is enabled, the release override cannot be executed; this is to avoid disturbing the automatic brake control and the associated processes.

The brake cannot be released by a release override with STO and is controlled by the SX6 safety module.



Risk of fatal injury due to gravity-loaded vertical axis!

If you use the release override, the brake is released when the power unit is deactivated. This can cause a gravity-loaded axis to fall in an uncontrolled manner.

- Only use the release override for gravity-free axes or secure them externally.

17.6.3 Internal and external brake control

With internal brake control, the drive controller controls the brakes and the release and engaging times are taken into account. For controller-based applications, you have the option of switching from internal (automatic) brake control through the drive controller to external brake control through a controller.

Overview

The following diagrams show the brake control, including relevant parameters from an application perspective.

Drive Based

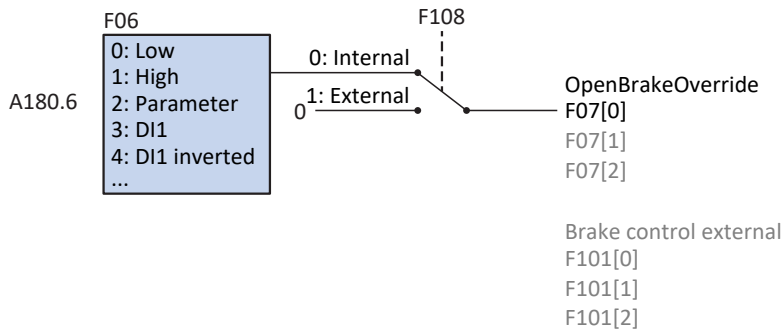

Fig. 49: Brake control in Drive Based applications

CiA 402

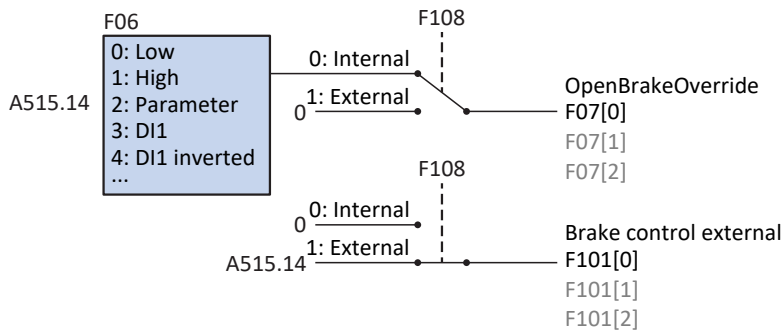

Fig. 50: Brake control in CiA 402 applications

PROFIdrive

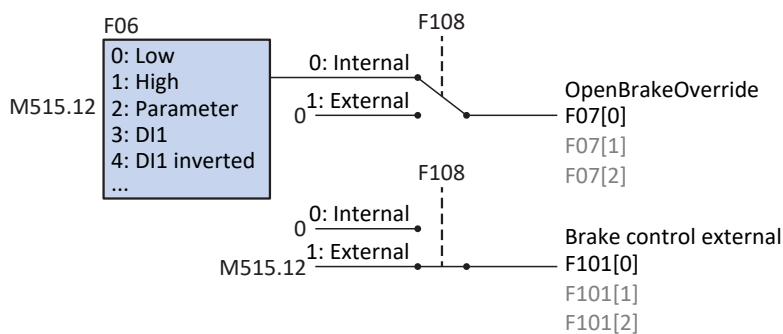

Fig. 51: Brake control in PROFIdrive applications

17.6.3.1 Internal brake control

With internal brake control, the drive controller controls the brakes and the release and engaging times are taken into account. You activate the internal brake control in parameter F00.

Information

To protect the holding brake, avoid engaging a brake when an axis is moving:

- Avoid uncontrolled stopping of a moving axis.
- If you would like to deactivate the enable signal for a moving axis, select A44 = 1: Active (default) so that a quick stop is carried out with Enable-off.
- As a fault reaction, always select a quick stop (A29 = 1: Active, default) or emergency braking (U30 = 1: Active).

17.6.3.1.1 Operation with 1 brake

After Enable-on, the brake releases along with the first command and remains released until one of the following events occurs:

- Event with fault reaction:
 - Power unit is locked
 - Quick stop (brake only engages at the end of the quick stop)
 - Emergency braking
- Enable-off
- Quick stop signal (brake only engages at the end of the quick stop)
- Brake is engaged at the end of the motion command (Drive Based applications: J27/J53; parameter depends on selected operating mode):
 - 1: MC_MoveAbsolute
 - 2: MC_MoveRelative
 - 3: MC_MoveAdditive
 - 5: MC_Stop
 - 6: MC_Home (requirement: I30 ≠ 5: Define home)
 - 11: MC_Halt

The brake can be released by means of a release override. This must be defined in parameter F06 (signal: F07).

The brake can be monitored for short-circuits and cable breaks. A drive controller hardware version ≥ 100 and firmware version V 6.5-L or later (nameplate: HW ≥ 100 ; parameter: E52[1] ≥ 100) are required. Monitoring can be set or deactivated in F105.

17.6.3.1.2 Operation with 1 brake (option SX6)

In combination with the SX6 safety module, it is possible to operate a brake that is safely controlled and monitored.

Information

If the brake is to be safely controlled and monitored, an SBC safety function must be parameterized in PASmotion Safety Configurator. For more information, refer to the manual for the SX6 safety module.

Brake release depends on the parameterization in PASmotion Safety Configurator:

- If the **coupling is inactive**, the brake is released when STO is deactivated
- For **brake 1 coupling**, the brake is released after Enable-on together with the first command
- For **brake 2 coupling**, the brake is released after Enable-on

If the coupling is active, the brake remains released until one of the following events occurs:

- Event with fault reaction:
 - Power unit is locked
 - Quick stop (brake only engages at the end of the quick stop)
 - Emergency braking
- Enable-off
- Quick stop signal (brake only engages at the end of the quick stop)
- Brake is engaged at the end of the motion command (Drive Based applications: J27/J53; parameter depends on selected operating mode):
 - 1: MC_MoveAbsolute
 - 2: MC_MoveRelative
 - 3: MC_MoveAdditive
 - 5: MC_Stop
 - 6: MC_Home (requirement: I30 ≠ 5: Define home)
 - 11: MC_Halt
- STO

The brake cannot be released by a release override with STO and is controlled by the SX6 safety module.

17.6.3.1.3 Operation with 2 brakes (option SX6)

In conjunction with the SX6 safety module, there is the option for implementing a concept with 2 brakes for safety-relevant applications.

Brake 1, typically the motor holding brake, is used for frequent and fast switching during stalled motion. Brake 2, usually an external additional brake with significantly higher switching times, remains open as a rule and is closed only in cases of exception. In this case, brake 1 is engaged for any intermediate stops required during working mode and brake 2 additionally ensures a secure hold during a prolonged stop, switched-off enable signal, STO or fault. Since the switching frequency of brake 2 can be substantially lower than the switching frequency of brake 1 as a result, a higher value can be achieved for the mean time to dangerous failure (MTTF_b).

Information

If the brake is to be safely controlled and monitored, an SBC safety function must be parameterized in PASmotion Safety Configurator. For more information, refer to the manual for the SX6 safety module.

Brake release depends on the parameterization in PASmotion Safety Configurator:

- If the **coupling is inactive**, the brake is released when STO is deactivated
- For **brake 1 coupling**, the brake is released after Enable-on together with the first command
- For **brake 2 coupling**, the brake is released after Enable-on

As a rule, the motor holding brake is coupled with brake 1 and the additional brake with brake 2.

If the coupling is active, the brakes remain released until one of the following events occurs:

- Event with fault reaction:
 - Power unit is locked
 - Quick stop (brake only engages at the end of the quick stop)
 - Emergency braking
- Enable-off
- Quick stop signal (brake only engages at the end of the quick stop)
- Brake is engaged at the end of the motion command (Drive Based applications: J27/J53; parameter depends on selected operating mode):
 - 1: MC_MoveAbsolute
 - 2: MC_MoveRelative
 - 3: MC_MoveAdditive
 - 5: MC_Stop
 - 6: MC_Home (requirement: I30 ≠ 5: Define home)
 - 11: MC_Halt
- STO

The brake cannot be released by a release override with STO and is controlled by the SX6 safety module.

17.6.3.1.4 Internal brake control based on control mode

The following chapters show the brake control depending on the control mode (B20) for 1 to 2 brakes with internal brake control through the drive controller.

17.6.3.1.4.1 B20 = 0 or 1

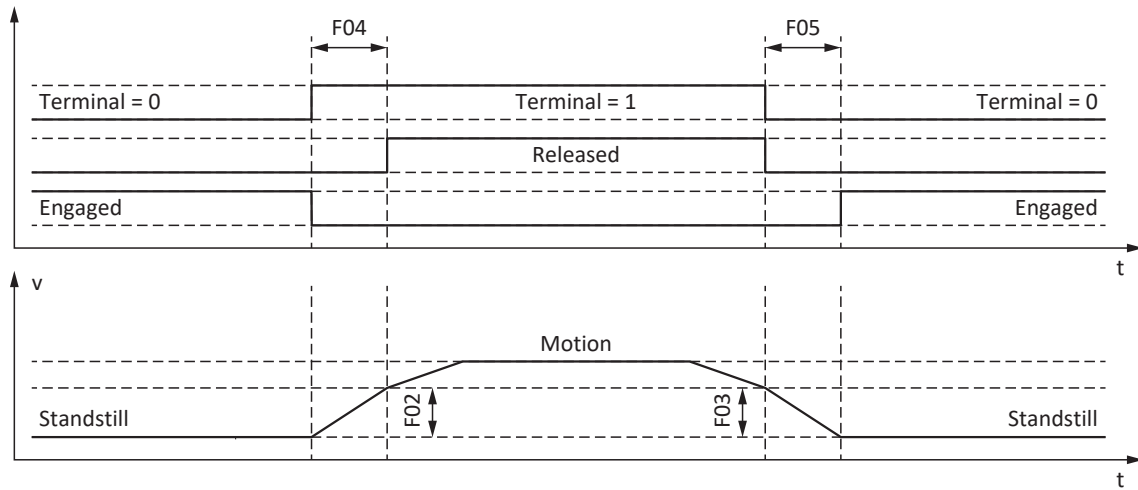

Fig. 52: Brake control for control mode B20 = 0: ASM - V/f-control or 1: ASM - V/f-slip compensated

In these control modes for asynchronous motors without a motor encoder, the axis is controlled to move within the release time F04.

Here, F02 is the velocity of the asynchronous motor that is built up during the release time F04. F03 is the velocity starting from which the brakes are controlled to engage.

During the release process, a set acceleration calculated from the velocity and release time takes effect (F02, F04). During the engaging process, a set deceleration calculated from the velocity and engaging time takes effect (F03, F05).

17.6.3.1.4.2 B20 = 2

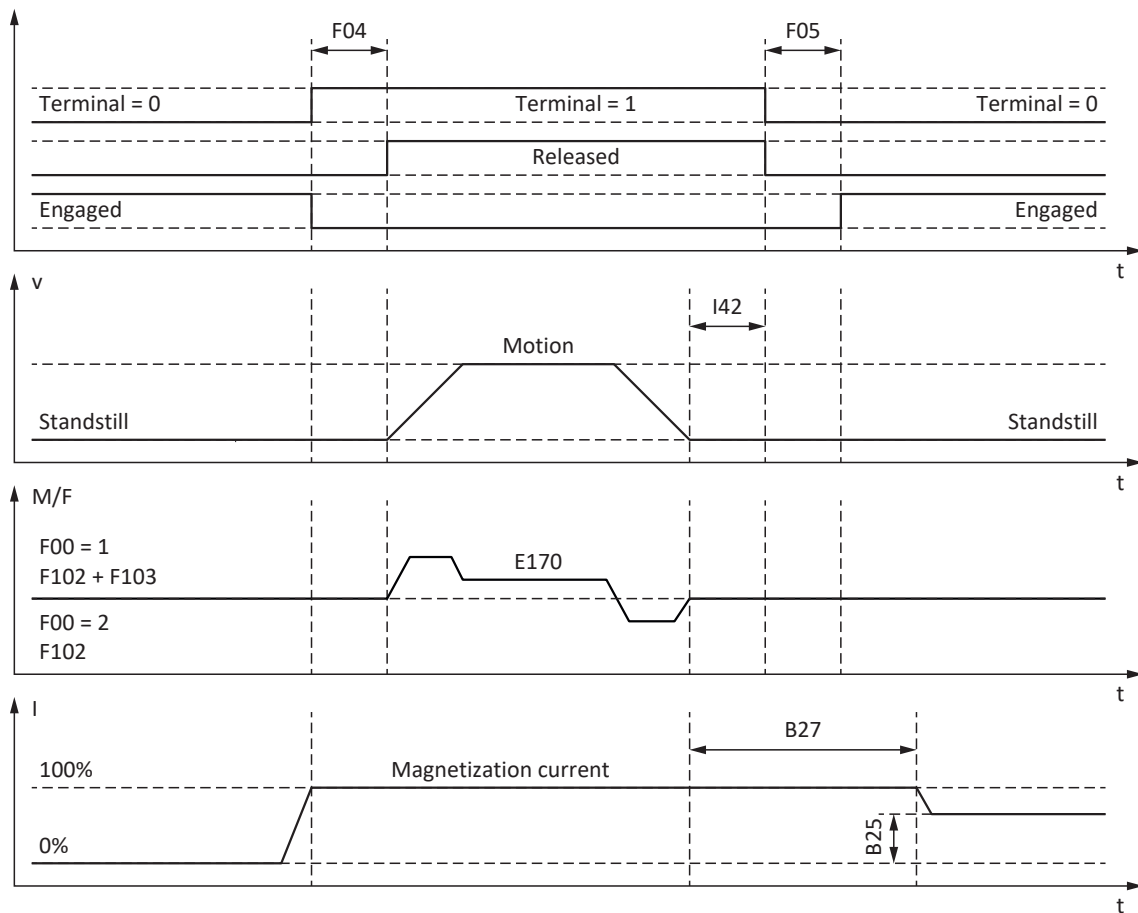

Fig. 53: Brake control for control mode B20 = 2: ASM - vector control

In this control mode for asynchronous motors with a motor encoder, the axis is controlled to move after the release time F04 has expired.

In the motion block and command operating modes, you can define a wait time for the brake to engage at the end of the motion command in parameter I42 (J27, J53). When this is done, multiple motion commands can be executed in succession without interruption from the brake engaging.

For specification of torque/force, E170 is the currently required set torque or the currently required set force M/F_{set} of the motor control (limit: E65, E66).

In F102, define a static feedforward control for torque/force for the velocity controller if you would like to set a base load for gravity-loaded axes. Depending on the boundary conditions of the machine, it may make sense to use different settings. For commissioning recommendations for gravity-loaded axes, see [Special case of load changes when the power unit is switched off](#) | 221].

With the setting F00 = 1: Active, the torque or force for the next brake release process (F103) is determined automatically and stored in non-volatile memory. The torque or force is not saved if F00 = 2: Do not save torque/force.

F103 is determined only for steady-state control and a completely released brake (F09). F103 is determined if the actual velocity of the motor encoder is less than the velocity window ($|E15| < |C40|$).

The hold magnetization B25 ensures that the motor is still supplied with current when the brake is engaged. The magnetization is reduced as soon as the motor has come to a standstill and the wait time B27 has expired.

B25 influences the thermal machine utilization. The thermal machine utilization is reduced as B25 decreases, but the reaction time simultaneously increases as the brakes are released.

17.6.3.1.4.3 B20 = 3

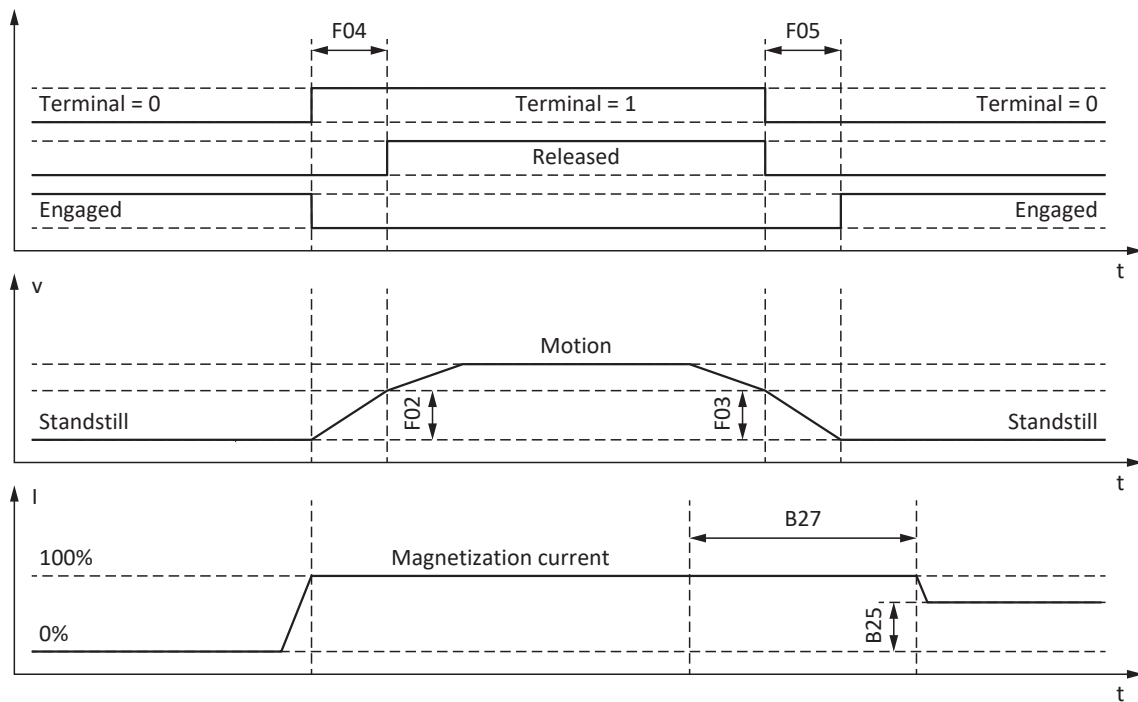

Fig. 54: Brake control for control mode B20 = 3: ASM - sensorless vector control

In this control mode for asynchronous motors without a motor encoder, the axis is controlled to move within the release time F04.

Here, F02 is the velocity of the asynchronous motor that is built up during the release time F04. F03 is the velocity starting from which the brakes are controlled to engage.

During the release process, a set acceleration calculated from the velocity and release time takes effect (F02, F04). During the engaging process, a set deceleration calculated from the velocity and engaging time takes effect (F03, F05).

The hold magnetization B25 ensures that the motor is still supplied with current when the brake is engaged. The magnetization is reduced as soon as the motor velocity has undershot the brake-engaging velocity F03 and the wait time B27 has expired.

B25 influences the thermal machine utilization. The thermal machine utilization is reduced as B25 decreases, but the reaction time simultaneously increases as the brakes are released.

17.6.3.1.4.4 B20 = 32, 48, 64, or 70

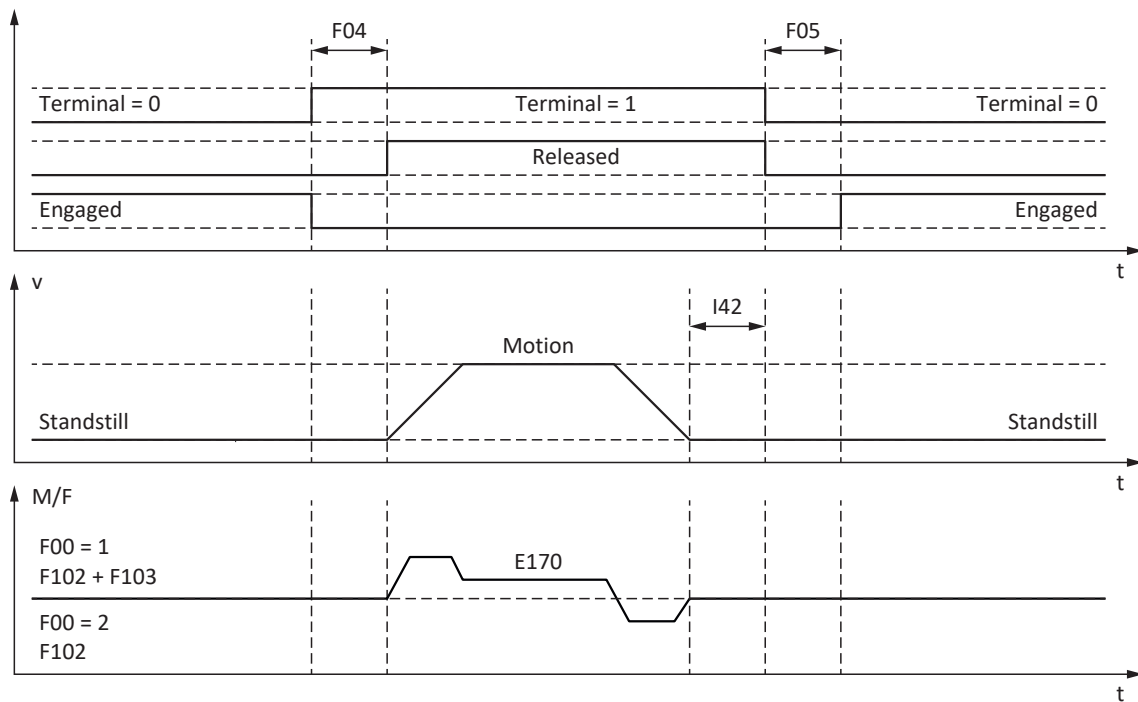

Fig. 55: Brake control for control mode B20 = 32: LM - sensorless vector control, 48: SSM-vector control incremental encoder, 64: SSM - vector control or 70: SLM - vector control

In these control modes for synchronous servo motors or synchronous linear motors with a motor encoder or Lean motors with sensorless vector control, the axis is controlled to move after the release time F04 has expired.

In the motion block and command operating modes, you can define a wait time for the brake to engage at the end of the motion command in parameter I42 (J27, J53). When this is done, multiple motion commands can be executed in succession without interruption from the brake engaging.

For specification of torque/force, E170 is the currently required set torque or the currently required set force M/F_{set} of the motor control (limit: E65, E66).

In F102, define a static feedforward control for torque/force for the velocity controller if you would like to set a base load for gravity-loaded axes. Depending on the boundary conditions of the machine, it may make sense to use different settings. For commissioning recommendations for gravity-loaded axes, see [Special case of load changes when the power unit is switched off](#) [▶ 221].

With the setting F00 = 1: Active, the torque or force for the next brake release process (F103) is determined automatically and stored in non-volatile memory. The torque or force is not saved if F00 = 2: Do not save torque/force.

F103 is determined only for steady-state control and a completely released brake (F09). F103 is determined if the actual velocity of the motor encoder is less than the velocity window ($|E15| < |C40|$).

Commutation finding process using Wake and Shake in combination with a brake

DANGER!

Risk of fatal injury due to gravity-loaded vertical axis!

Gravity-loaded axes can sink during a commutation finding process using Wake and Shake because the brake for the commutation finding process has to be released.

- Use the 48: SSM-vector control incremental encoder and 70: SLM - vector control control modes in combination with a commutation finding process using Wake and Shake only for axes without a gravity load.
- For gravity-loaded axes, use motors with an absolute encoder.

For more information on commutation finding via Wake and Shake, see [Commutation finding \[▶ 364\]](#).

17.6.3.2 External brake control in V 6.5-L or later

For the CiA 402 or PROFIdrive application, parameter F108 offers the option of switching from internal (automatic) brake control through the drive controller to external brake control through a controller.

With external brake control, brake 2 behaves like brake 1, i.e. the control always makes both brakes release and engage together.

In conjunction with the SX6 safety module, the extended safety technology can even intervene for external brake control. For all other cases:

WARNING!

Injury to persons and material damage due to axis movement!

For external brake control, the brake does not engage automatically in the event of faults or Enable-off. For Enable-on or the start of a motion, the brake is not automatically released. The external brake control is independent of the device state and motion core through the controller.

- Guarantee a suitable process in the controller and take suitable measures to ensure safety.
- When releasing the brake, also take into account the motor-side requirements (e.g. required time for building up magnetization in the case of asynchronous motors or for position determination in the case of Lean motors).

The controller can check whether the brakes are engaged or released (E201, bits 3 and 4) before set values for position and velocity are specified.

For external brake control, bit 14 of parameter A515 is the source of F101[0] in the CiA 402 application and bit 12 of M515 in the PROFIdrive application (prerequisite: F108 = 1: External (plc)).

17.6.4 Brake release time and brake engaging time

The release times of the connected brakes are defined in parameter F04, the engaging times are defined in parameter F05:

- F04[0]: release time for brake 1
- F04[1]: release time for brake 2
- F05[0]: engaging time for brake 1
- F05[1]: engaging time for brake 2

When a movement is started, the movement and status signals are delayed by the time F04 to prevent movement against a brake that is not yet fully open.

When the brake engages, the control still remains active for the time F05 to prevent a gravity-loaded axis from sinking. For STO, the brake engages immediately. The behavior for deactivation of the enable signal can be defined with A44 (brake engages immediately or after a quick stop).

Motors with an electronic nameplate

In motors with an electronic nameplate, the values during initial coupling of the motor and drive controller or when the action B06 is started are taken over from the electronic nameplate (prerequisite: B04 = 64: Active).

If the electronic nameplate also contains the release time and engaging time of the brakes integrated into the motor adapter (ServoStop), then these are also taken into account. The following additional setting is required for this, up to and including firmware V 6.5-H: B28 = 1: All data.

Sources for the values from the electronic nameplate:

- R50: nameplate release time of the motor brake
- R51: nameplate engaging time of the motor brake
- R67: nameplate release time of the motor adapter brake
- R68: nameplate engaging time of the motor adapter brake

Motors without an electronic nameplate

Depending on the connection type, you have to calculate the release time and engaging time of the brake differently.

For a direct connection of the brake, take into account a safety factor of 1.3 for the release and engaging times when transferring the values to the drive controller.

Guide values:

- $F04 = 1.3 \times t_{2B}$
- $F05 = 1.3 \times t_{1B}$

For an indirect connection of the brake, e.g. through a contactor, take into account $1.2 \times$ the switching time of the contactor in addition to the guide value for direct connection for both the release time and engaging time.

If you do not know the release time and engaging time of the brake, you can calibrate these using the action F96.

17.6.5 Time between 2 release processes

Information

The time between two brake release processes must be at least 1 s. If this is not observed, the 2nd release process will be delayed.

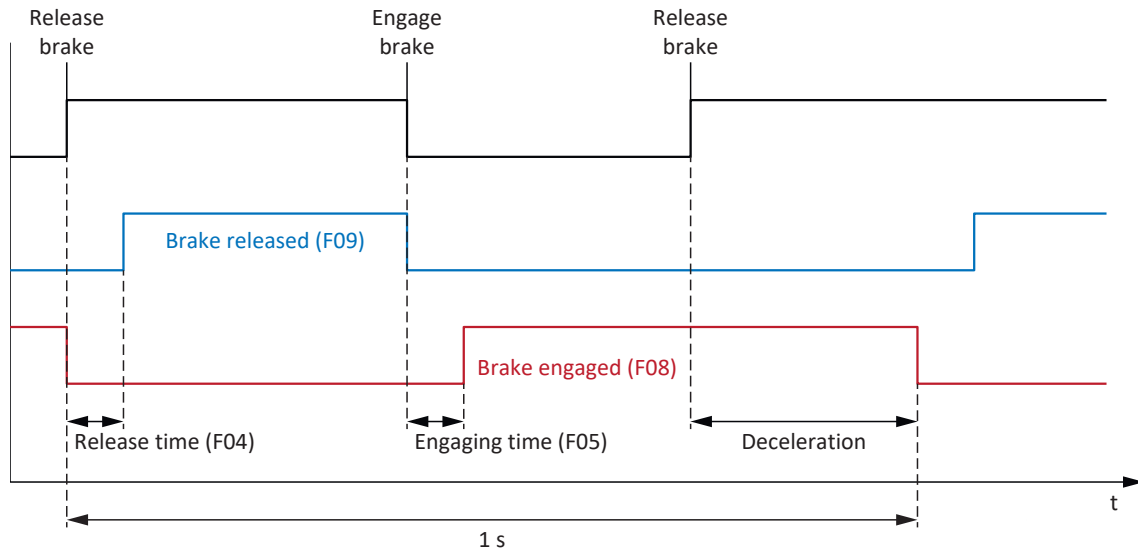

Fig. 56: Minimum time between 2 release processes for the brake

17.6.6 Calibrating the brake

The release and engaging times of the brake can be calibrated using the action F96. This action is not required for motors with an electronic nameplate because these values are taken over from the electronic nameplate during initial coupling of the motor for the drive controller.

⚠ DANGER!

Risk of fatal injury due to gravity-loaded vertical axis!

During this action, the brakes are released and movement starts. The motor cannot generate any or can only generate limited torque/force during this time. This can cause a gravity-loaded vertical axis to drop.

- Make sure that safe movement in the specified travel range is possible.
- Secure the area extending beyond the travel range for the case of further lowering of the gravity-loaded vertical axis.

Prerequisites

The action F96 is only available in the following control modes (B20):

- 2: ASM - vector control
- 3: ASM - sensorless vector control
- 32: LM - sensorless vector control
- 48: SSM-vector control incremental encoder
- 64: SSM - vector control
- 70: SLM - vector control

F96 can be carried out also for loaded axes. In this case, the velocity controller should be optimized and the load must not be more than 2/3 of the maximum torque or force currently permitted (E65, E66).

Required parameters

Define the permitted direction of motion for calibrating the brake in parameter B306, the standstill window in parameter B307.

The travel range with unloaded axis is approx. 2 motor revolutions (synchronous linear motors: approx. 2 m). To determine the travel path exactly, please include the gear unit and feed in the calculation.

Sequence of the action

During the action, the axis rotates at a fixed set speed of 20 rpm (set velocity for synchronous linear motors: 2 m/min). Initially, for a released brake, a measurement run is carried out for the duration of 1 s. Then the axis moves against the engaging brake. After detection of the brake engaging (timeout 2 s), the axis stops. This is followed by a standstill of 2 s (recovery phase). Then the axis moves against the releasing brake. After detection of the brake release (timeout 2 s), the axis continues moving for 0.5 s and then stops.

If two brakes are connected, the action F96 is always carried out for both brakes.

The determined times are stored in F04 and F05:

- F04[0]: release time for brake 1
- F04[1]: release time for brake 2
- F05[0]: engaging time for brake 1
- F05[1]: engaging time for brake 2

Saving values

For the measured values to be saved in non-volatile memory, the action A00 has to be carried out after this.

Alternatively, the action B06 can be used to retrieve the values from the electronic nameplate, provided that it contains the brake data.

Results

After the action F96 is started, the progress can be observed in parameter F96[1], and after the action is completed, F96[2] can be used to call up the results of calibrating.

The action F96 evaluates the measured time with the safety factor of 1.2. This means that the values entered in F04 and F05 are 1.2 times greater than the actually measured values.

17.6.7 Brake test

The action B300 Test brake checks whether the brake can still apply the required holding torque or holding force.



Risk of fatal injury due to gravity-loaded vertical axis!

During this action, the closed brake is loaded with a specified test torque or a specified test force. If the test torque or test force exceeds the holding torque or holding force of the brake, this results in movement of the axis. This can cause a gravity-loaded vertical axis to drop.

- Make sure that safe movement is possible.

Requirements

The action B300 requires a position encoder and is permitted only in the following control modes (B20):

- 2: ASM - vector control
- 32: LM - sensorless vector control
- 48: SSM-vector control incremental encoder
- 64: SSM - vector control
- 70: SLM - vector control

Required parameters

Enter the test torque or test force in the parameters B304 and B305:

- B304[0]: Positive set torque/positive set force for brake 1
- B304[1]: Positive set torque/positive set force for brake 2
- B305[0]: Negative set torque/negative set force for brake 1
- B305[1]: Negative set torque/negative set force for brake 2

Define the permitted travel direction in B306. If both directions of rotation are permitted, travel first proceeds in the positive direction. Enter the angle of rotation of the motor that the drive evaluates as a standstill in B307.

To define the test torques or test forces, note that the motor is limited to the values in C03 and C05. If larger values are entered in B304 and B305, they cannot be achieved. In addition, make sure that no device-specific limitations take effect. To do so, check the parameters E65 and E66 during the brake test.

Travel path for brake test

- Synchronous servo motors, Lean motors and asynchronous motors: If the brake can hold the test torque, then the maximum travel path is 0.125 motor revolutions.
- Synchronous linear motors: If the brake can hold the test force, then the maximum travel path is 0.8 mm.

Sequence of the action

If the brake is released, then the encoder is tested first. For the encoder test, the motor rotates at approximately 60 rpm at a maximum of 45° in both directions of rotation. Then the brake engages and a parameterizable test torque or test force is applied to the drive in each permitted direction of rotation. If the drive detects motion, then the brake was unable to apply the required holding torque or holding force and the test has failed.

Results

After the action B300 is started, the progress can be observed in parameter B300[1], and after the action is completed, B300[2] can be used to call up the test results.

17.6.8 Torque calculation

In the following chapters, you will find information for calculating the torques that you have to enter in B304 and B305 for the brake test.

17.6.8.1 Torques for synchronous servo motors

To calculate the torques, you need the following values:

- M_B : Select the braking torque that you have designed and that is required for your application. M_{1Bstat}
- M_0 : Stall torque
- I_0 : Stall current
- $I_{2N,PU}$: Nominal output current of the drive controller

In the first step, calculate the ratio of torques as a percentage:

$$K = \frac{M_B}{M_0} \times 100 \%$$

In the next step, determine the current for M_B :

$$I = I_0 \times K$$

Compare I to $I_{2N,PU}$ of the drive controller:

If $I \leq 2 \times I_{2N,PU}$, then:

$$B304 = K \text{ and } B305 = -K$$

If $I > 2 \times I_{2N,PU}$, then the drive controller cannot generate the test torque that you have designed.

Example

- $M_B = 10 \text{ Nm}$
- $M_0 = 6.6 \text{ Nm}$
- $I_0 = 4.43 \text{ A}$
- $I_{2N,PU} = 6 \text{ A}$

$$K = \frac{10 \text{ Nm}}{6,6 \text{ Nm}} \times 100 \% = 151\%$$

$$I = 4.43 \text{ A} \times 151\% = 6.69 \text{ A}$$

$$I_{2N,PU} \times 2 = 12 \text{ A}$$

$$6.69 \text{ A} < 12 \text{ A}$$

Results: B304 = 151% and B305 = -151%

17.6.8.2 Torques for asynchronous motors

To calculate the torques, you need the following values:

- M_B : Select the braking torque that you have designed and that is required for your application. Alternatively, perform a calculation with the nominal braking torque of the motor brake $M_{N,B}$
- M_N : Nominal torque of the motor
- M_k : Breakdown torque of the motor
- $I_{2N,PU}$: Nominal output current of the drive controller
- $I_{d,ref}$ (E171): Magnetization-generating reference current in the d/q coordinate system
- $I_{q,ref}$ (E172): Torque/force-generating reference current in the d/q coordinate system

To obtain the correct values from E171 and E172, complete the project configuration of the motor, transfer the project to the drive controller and save it. Then read out the values in online operation.

In the first step, calculate the ratio of torques as a percentage:

$$K = \frac{M_B}{M_N} \times 100 \%$$

In the next step, determine the current for M_B :

$$I = \sqrt{I_{d,ref}^2 + (K \times I_{q,ref})^2}$$

Compare I to $I_{2N,PU}$ of the drive controller:

If $I \leq 1.8 \times I_{2N,PU}$, then:

B304 = K and B305 = $-K$

If $I > 1.8 \times I_{2N,PU}$, then the drive controller cannot generate the test torque that you have designed.

Check whether the motor can apply the required test torque:

$$M_k/M_B > 1$$

Example

- $M_B = 10 \text{ Nm}$
- $M_N = 5.12 \text{ Nm}$
- $M_k = 11.8 \text{ Nm}$
- $I_{2N,PU} = 2.3 \text{ A}$
- $I_{d,ref} = 1.383 \text{ A}$
- $I_{q,ref} = 1.581 \text{ A}$

$$K = \frac{10 \text{ Nm}}{5.12 \text{ Nm}} \times 100 \% = 195 \%$$

$$I = \sqrt{(1.383 \text{ A})^2 + (195 \% \times 1.581 \text{ A})^2} = 3.38 \text{ A}$$

$$I_{2N,PU} \times 1.8 = 4.14 \text{ A}$$

$$3.38 \text{ A} < 4.14 \text{ A}$$

$$M_k/M_B = 1.18$$

$$1.18 > 1$$

Results: B304 = 195% and B305 = -195%

17.6.9 Bedding in the brake

For the actions B301 Grind brake and B302 Brake 2 grind, the brake repeatedly engages for approximately 0.7 s and then is released for approximately 0.7 s while the motor rotates at approximately 20 rpm. This grinds off any deposits on the friction surface that can negatively influence the holding function of the brake.

Brake 2 is available exclusively in combination with the SX6 safety module.



Risk of fatal injury due to gravity-loaded vertical axis!

During this action, the brakes are released and movement starts. The motor cannot generate any or can only generate limited torque/force during this time. This can cause a gravity-loaded vertical axis to drop.

- Make sure that safe movement in the specified travel range is possible.
- Secure the area extending beyond the travel range for the case of further lowering of the gravity-loaded vertical axis.

Required parameters

You can define the following parameters:

- How often the brake engages while rotating in one direction (B308)
- How often the drive should rotate in each direction (B309)
- Whether a direction of rotation is blocked (B306)

Set speed/velocity and travel range

- Synchronous servo motors, Lean motors and asynchronous motors:
 - Fixed set speed: 20 rpm
 - Travel range: $B308 \times 0.5$ motor revolutions
- Synchronous linear motors:
 - Fixed set velocity: 20 m/min
 - Travel range: $B308 \times 0.5$ m

Results

After the action is started, the progress can be observed in parameter B301[1] for brake 1 and in B302[1] for brake 2. After the action is completed, the result for brake 1 can be called up in B301[2] and for brake 2 in B302[2].

17.6.10 Brake connection as digital output

Terminal X2A is used to connect the brake of axis A. For double-axis controllers, the brake of axis B is connected to X2B. Alternatively, both terminals can be used as digital outputs.

The 24 V_{DC} supply must be guaranteed via terminal X300. Furthermore, the setting for brake control must be deactivated (F00 = 0: Inactive).

In DriveControlSuite, you can define the source of the digital signals via the parameters F59 and F60 (Terminals wizard > Brake connection as digital output). The status is displayed in parameter E27, bit 14 and bit 15.

Information

By default, parameter A900 is stored as the source so that the output is switched on when Enable-on is activated. This serves to protect any connected brake.

When using a brake connection as a digital output, it is not monitored and the switch limit at 1 Hz is not active.

17.6.11 Special case of load changes when the power unit is switched off

Depending on the boundary conditions of the machine, it may make sense to use different settings.

Recommendation for commissioning with gravity-loaded axes

If load changes occur only when the power unit is switched on, leave the presets.

On the other hand, if load changes also occur when the power unit is switched off, reduce the correcting process when the brakes are released:

1. F00 Brake:
Select 2: Do not save torque/force to save F103 only in volatile memory.
2. F102 Torque/force feed forward:
Enter the determined value for the base load so that only the load difference needs to be adjusted when the load changes.
3. Reduce the correcting process when releasing the brakes by optimizing the velocity controller.

Determining the base load

1. F102 Torque/force feed forward:
Set the value to 0.0%.
2. Load the axis with the base load.
3. Select the Jog control panel wizard.
4. Enable the axis and let it stand in one position with released brakes in active position control.
5. Determine a stable value for E02 using a scope image; this value corresponds to the base load.
6. Select the Jog control panel wizard.
7. Deactivate the enable signal of the axis.
8. F102 Torque/force feed forward:
Enter the determined base load.
9. A00 Save values:
Save the value in non-volatile memory.

18 Predictive Maintenance

Predictive Maintenance (PMR) in the context of Industry 4.0 enables a machine to predict and signal the optimal time when components should be serviced or replaced.

Especially in industrial automation technology, geared motors are system-relevant components and therefore very important for predictive analysis. One way to infer the service life of a geared motor is based on the loads to which the gear unit is subjected during its lifetime.

The Predictive Maintenance function in the drive controller monitors your connected geared motor. Its life performance is calculated using a model-based analysis procedure and mapped in parameters. These parameters can be displayed via the higher-level controller or in the DriveControlSuite commissioning software. This allows you to plan maintenance optimally and proactively. The solution includes 3 essential components. The load matrix is a solid data base for recording the real-world load situations of your machine and improving quality and economic efficiency. The life performance indicator is the value for the calculated life performance of the geared motor. The recommendation to replace the geared motor can be displayed in DriveControlSuite and is also provided to the controller as a parameter that can be read out.

Predictive Maintenance is automatically active for geared motors with an electronic nameplate as of production date 04/2022. For geared motors without an electronic nameplate or for older geared motors, monitoring can be activated manually in the DriveControlSuite commissioning software by using a wizard (V 6.5-G and later and associated firmware in V 6.5-G and later).

Your advantages at a glance

- Prognosis of the optimal time for maintenance
- Extension of the maintenance intervals
- Reduction of spare part inventories through controlled procurement
- Service concepts

Predictive Maintenance requires no additional external sensors, no additional wiring and no additional components.

18.1 Legal disclaimer

As of 2022 in DriveControlSuite in V 6.5-G or later, functions that estimate the aging and wear of the components used have been implemented in our drive systems.

The estimates are used to make various kinds of predictions to provide support for decisions about preventative replacement. This computer-based support is usually called Predictive Maintenance or something similar.

As development matures, this support is expected to become increasingly precise. On the one hand, this is partly due to our growing statistical knowledge. On the other hand, the algorithms are also refined over time and the number of sensors used increases.

Nevertheless, statistical errors are to be expected. In principle, there are two types of errors:

- False positive: The algorithm predicts failure in the future, although damage has already occurred in the system.
- False negative: The algorithm recommends replacement although the service life is evidently still long.

By using this function, it is acknowledged that the occurrence of statistical errors is typical of the system and is not cause for any liability on the part of the manufacturer. There is no entitlement to compensation for damages due to a miscalculation by the algorithm.

18.2 Displaying the state

Open the corresponding wizard in DriveControlSuite if you want to check the state of Predictive Maintenance and the relevant parameters.

- ✓ There is an online connection between DriveControlSuite and the drive controller or reverse documentation is available.
- 1. Select the respective drive controller in the project tree and click on the configured axis whose monitoring you would like to check in the Project menu > Wizard area.
- 2. Select the Predictive Maintenance wizard.
- ⇒ The state is displayed directly as an icon with a corresponding note.
- ⇒ R100 PRM state:
Displays the state of Predictive Maintenance. If R100 = 0: Inactive, you must configure Predictive Maintenance manually.
- ⇒ R101 PRM life performance indicator:
Displays the calculated life performance of the geared motor; from a value $\geq 90\%$, replacement of the geared motor is recommended.
- ⇒ R112 PRM gear unit designation:
Displays the type designation of the geared motor being monitored in Predictive Maintenance.

18.3 Configuring Predictive Maintenance

Predictive Maintenance is automatically active for geared motors with an electronic nameplate as of production date 04/2022. Configure monitoring in DriveControlSuite only in the following cases:

- Geared motors with a manufacturing date prior to 04/2022
- Geared motors without an electronic nameplate

In the cases mentioned above, Predictive Maintenance is inactive. First check the status of Predictive Maintenance with an existing online connection (see [Displaying the state](#) [▶ 223]). If R100 = 0: Inactive, you can then carry out the manual configuration in offline mode.

Configuring Predictive Maintenance via the serial number

- ✓ You have the serial number of the gear unit.
1. Select the relevant drive controller in the project tree and click on the first projected axis in the Project menu > Wizard area.
 2. Select the Predictive Maintenance wizard.
 3. Click Configure Predictive Maintenance (Internet).
 - ⇒ The Configure Predictive Maintenance (Internet) dialog box opens.
 4. Click Proxy settings.
 - ⇒ The Proxy settings dialog box opens.
 5. Select the desired option for the proxy setting.
For manual proxy configuration:
 - 5.1. If you are using a proxy server, specify the name of the proxy server or the IP address in the address field and the port of the proxy server in the Port field.
 - 5.2. If you are using a proxy server with a login, also specify the username and password for login.
 - 5.3. Use Test connection to make sure that a connection to the proxy server is possible.
 6. Confirm with OK.
 - ⇒ The Proxy settings dialog box closes.
 7. Enter the serial number of your gear unit in the Configure Predictive Maintenance (Internet) dialog box.
 8. Click Start download.
 - ⇒ The data is downloaded and automatically written to the associated parameters.
 9. After a successful download, confirm with OK
 10. Repeat the steps for the 2nd axis (only for double-axis controllers).
 - ⇒ You have activated Predictive Maintenance.

Then transfer the configuration to the drive controller, save it and restart the drive controller (see Transmitting and saving the configuration).

Configuring Predictive Maintenance manually

If automatic configuration via the serial number fails, you can alternatively configure Predictive Maintenance manually.

Information

The required information can be found in the order confirmation for your gear unit, for example. Alternatively, you can scan the QR code on the nameplate or retrieve it online using the serial, delivery note or invoice number at: <https://id.stober.com>.

- ✓ The order confirmation is available to you or you have access to the electronic product ID of your gear unit.
- 1. Select the relevant drive controller in the project tree and click on the first projected axis in the Project menu > Wizard area.
- 2. Select the Predictive Maintenance wizard.
- 3. Click Configure Predictive Maintenance (local).
 - ⇒ The Configure Predictive Maintenance (local) dialog box opens.
- 4. Select the series of your gear unit.
- 5. Select the size of your gear unit.
- 6. Then select your gear unit from the list.
- 7. Confirm with OK.
- 8. Repeat the steps for the 2nd axis (only for double-axis controllers).
- ⇒ You have activated Predictive Maintenance.

Then transfer the configuration to the drive controller, save it and restart the drive controller (see Transmitting and saving the configuration).

Configuring Predictive Maintenance using the database file

If STOBER has provided you with a database containing your specific gear unit data, you can load it into DriveControlSuite and then configure your gear unit manually.

Information

The required information can be found in the order confirmation for your gear unit, for example. Alternatively, you can scan the QR code on the nameplate or retrieve it online using the serial, delivery note or invoice number at: <https://id.stober.com>.

- ✓ You have saved the database containing your gear unit data locally.
- ✓ The order confirmation is available to you or you have access to the electronic product ID of your gear unit.
- 1. Select the relevant drive controller in the project tree and click on the first projected axis in the Project menu > Wizard area.
- 2. Select the Predictive Maintenance wizard.
- 3. Click the  button.
 - ⇒ The Open PRM database dialog box opens.
- 4. Navigate to the directory, select the database and open it.
 - ⇒ The Configure Predictive Maintenance (local) dialog box opens.
- 5. Select the series of your gear unit.
- 6. Select the size of your gear unit.
- 7. Then select your gear unit from the list.
- 8. Confirm with OK.
- 9. Repeat the steps for the 2nd axis (only for double-axis controllers).
 - ⇒ You have activated Predictive Maintenance.

Then transfer the configuration to the drive controller, save it and restart the drive controller (see Transmitting and saving the configuration).

18.4 Sending the load matrix

Open the associated wizard in DriveControlSuite and send the load matrix to STOBER if you need assistance with data analysis, for example. With an existing online connection, the load matrix is read from the drive controller and sent as a JSON file. In offline mode, you can send a load matrix already exported in JSON format.

Information

It is not possible to infer specific machine cycles based on the load matrix. The load matrix contains only highly condensed, statistical features.

Sending the load matrix (drive controller)

- ✓ Predictive Maintenance is active (R100 = 1: Active).
 - ✓ There is an online connection between DriveControlSuite and the drive controller or reverse documentation is available.
1. Select the relevant drive controller in the project tree and click on the projected axis whose load matrix you want to send in the project menu > Wizard area.
 2. Select the Predictive Maintenance wizard > Load matrix.
 3. Fill in the required fields.
 4. Click Send load matrix (drive controller).
 - ⇒ The Send load matrix (drive controller) dialog box opens.
 - ⇒ The source, destination and amount of data of the current load matrix are displayed.
 5. Click Proxy settings.
 - ⇒ The Proxy settings dialog box opens.
 6. Select the desired option for the proxy setting.
For manual proxy configuration:
 - 6.1. If you are using a proxy server, specify the name of the proxy server or the IP address in the address field and the port of the proxy server in the Port field.
 - 6.2. If you are using a proxy server with a login, also specify the username and password for login.
 - 6.3. Use Test connection to make sure that a connection to the proxy server is possible.
 7. Confirm with OK.
 - ⇒ The Proxy settings dialog box closes.
 8. In the Send load matrix (drive controller) dialog box, click Send.
 - ⇒ The sending process starts and the data is transmitted to STOBER.
 9. Close the dialog box after sending has been completed successfully.

Sending the load matrix (directory)

- ✓ You have exported the load matrix in JSON format.
- 1. Select the relevant drive controller in the project tree and click on the projected axis whose exported load matrix you want to send to STOBER in the project menu > Wizard area.
- 2. Select the Predictive Maintenance wizard > Load matrix.
- 3. Click Send load matrix (directory).
 - ⇒ The dialog box for selecting the file opens.
- 4. Navigate to the load matrix previously exported in JSON format and select it.
- 5. Click Open.
 - ⇒ The Send load matrix (directory) dialog box opens.
 - ⇒ The source, destination and data volume of the current load matrix are displayed in the dialog box.
- 6. Click Proxy settings.
 - ⇒ The Proxy settings dialog box opens.
- 7. Select the desired option for the proxy setting.
For manual proxy configuration:
 - 7.1. If you are using a proxy server, specify the name of the proxy server or the IP address in the address field and the port of the proxy server in the Port field.
 - 7.2. If you are using a proxy server with a login, also specify the username and password for login.
 - 7.3. Use Test connection to make sure that a connection to the proxy server is possible.
- 8. Confirm with OK.
 - ⇒ The Proxy settings dialog box closes.
- 9. In the Send load matrix (directory) dialog box, click Send.
 - ⇒ The sending process starts and the data is transmitted to STOBER.
- 10. Close the dialog box after sending has been completed successfully.

18.5 Exporting the load matrix

If you want to check or analyze the data, use the associated DriveControlSuite wizard to export the load matrix. With an existing online connection, the load matrix is read directly from the drive controller for export. If the data in your project is already available in DriveControlSuite, you can also export the data in offline mode.

- ✓ Predictive Maintenance is active (R100 = 1: Active).
- ✓ There is an online connection between DriveControlSuite and the drive controller or reverse documentation is available.
- 1. Select the relevant drive controller in the project tree and in the Project menu > Wizard area click on the projected axis whose load matrix you want to export.
- 2. Select the Predictive Maintenance wizard > Load matrix.
- 3. Fill in the required fields.
- 4. Click Export load matrix (directory).
 - ⇒ The Export load matrix (directory) dialog box opens.
- 5. Select the directory to which you want to export the load matrix.
- 6. Select the desired file type (JSON or CSV).
- 7. Assign a file name and select `.json` or `.csv` as the file extension.
- 8. Confirm with Save.
- ⇒ The load matrix is saved as a JSON or CSV file (*.json, *.csv).

18.6 Resetting the load matrix

The load matrix is stored in non-volatile memory on the SD card along with the life performance indicator every 30 minutes.

You can manually reset the load matrix as necessary.

If an SD card is inserted, the existing load matrix is moved to a backup folder before resetting. When resetting, both the load matrix on the SD card and the load matrix stored in volatile memory in the drive controller are reset.

- ✓ Predictive Maintenance is active (R100 = 1: Active).
- 1. Select the relevant drive controller in the project tree and click on the projected axis whose load matrix you want to reset in the Project menu > Wizard area.
- 2. Select the Predictive Maintenance wizard > Load matrix > Reset load matrix.
- 3. Click Reset load matrix.
- ⇒ The load matrix is reset.
- ⇒ R105[1] indicates the progress.
- ⇒ R105[2] outputs the result of the action.

18.7 Displaying a 3D load matrix

The load matrix represents the frequency distribution of speeds and torques that occurred at the output of the monitored geared motor. If you want to check the speeds and torques that have occurred, open the associated wizard in DriveControlSuite for a three-dimensional, rotatable display of the load matrix. With an existing online connection, the load matrix is read directly from the drive controller for the display. If the data in your project is already available in DriveControlSuite, the load matrix can also be displayed in offline mode.

- ✓ Predictive Maintenance is active (R100 = 1: Active).
 - ✓ There is an online connection between DriveControlSuite and the drive controller or reverse documentation is available.
1. Select the relevant drive controller in the project tree and click on the projected axis whose load matrix you want to display in the Project menu > Wizard area.
 2. Select the Predictive Maintenance wizard > Load matrix > Load matrix 3D.
 - ⇒ The load matrix is displayed as a 3D column diagram.
 3. Customize the display by changing the default settings for time and scaling according to your needs.

For more information on operation, see [3D load matrix](#) [▶ 234].

18.8 Resetting the life performance indicator

The life performance indicator is stored in non-volatile memory in the drive controller every 10 minutes, and on the SD card together with the load matrix every 30 minutes.

In certain cases, you may need to manually reset the life performance indicator:

- After replacing a geared motor without an electronic nameplate with an identical geared motor
- After servicing a geared motor (with or without electronic nameplate)

In both cases, monitoring remains active for the entire period. However, since the life performance indicator of the replaced or serviced geared motor has the value 0%, you must also reset the life performance indicator in the drive controller.

Information

Resetting the life performance indicator also resets the operating time of the gear unit and the counter for instances of exceeding the torque for Predictive Maintenance (R123, R124).

- ✓ Predictive Maintenance is active (R100 = 1: Active).
1. Select the relevant drive controller in the project tree and click on the first projected axis whose life performance indicator must be reset in the Project menu > Wizard area.
 2. Select the Predictive Maintenance wizard > Reset life performance indicator.
 3. Click Reset life performance indicator.
 - ⇒ The life performance indicator is reset.
 - ⇒ R104[1] indicates the progress.
 - ⇒ R104[2] outputs the result of the action.
 - ⇒ R101 displays the life performance indicator.

18.9 Information on activation, operation and replacement

Pay attention to the following information on activating Predictive Maintenance and for operating and replacing components.

Activation

The following requirements apply for successful activation of Predictive Maintenance:

- STOBER system (consisting of drive controllers and geared motors from STOBER)
- Automatic activation for geared motors with a manufacturing date as of 04/2022
- Manual configuration required for geared motors with an older manufacturing date or geared motors without an electronic nameplate
- Plugged-in SD card for non-volatile storage of the load matrix
- No linear motor (control mode B20 ≠ 70: SLM - vector control)
- Gear units not connected in series, as this is not supported by the life performance indicator

Operation

Predictive Maintenance is continued without interruption after restarting the drive controller if the following requirements are met:

- SD card permanently inserted in the drive controller
- Uninterrupted connection of drive controller and geared motor
- Constant gear ratio of the gear unit (Drive Based or PROFIdrive: C15, C16; CiA 402: A584)

Replacement

After the drive controller has been replaced, monitoring can be continued without interruption by transferring the data from the SD card.

After replacing a geared motor with an electronic nameplate, the existing data is not overwritten if it is replaced with a new motor, but a new data record is created. With the original data, the drive controller is able to continue monitoring the geared motor after the geared motor has been replaced.

In certain cases, you may need to manually reset the life performance indicator:

- After replacing a geared motor without an electronic nameplate with an identical geared motor
- After servicing a geared motor (with or without electronic nameplate)

In both cases, monitoring remains active for the entire period. However, since the life performance indicator of the replaced or serviced geared motor has the value 0%, you must also reset the life performance indicator in the drive controller.

18.10 More about Predictive Maintenance?

The following chapters summarize the essential terms of Predictive Maintenance and provide you with further relevant information on the subject.

18.10.1 Load matrix

The load matrix represents the data base for recording the real-world load situations of machines and improving the quality and economic efficiency. It represents the frequency distribution of speeds and torques that occurred at the output of the geared motor. The load matrix and other information are stored in DriveControlSuite in parameter R118. The information relevant for Predictive Maintenance is also made available to the controller via this parameter.

Information

For performance reasons, parameter R118 is not displayed in the parameter list of DriveControlSuite. The parameter data can be accessed indirectly via the load matrix wizard or via acyclic fieldbus communication.

Information

The load matrix is only recorded if the axis is enabled (A900 = 1).

Structure and scope

The load matrix divides speed and torque into equidistant classes. For the speed, 21 classes are available for both directions of rotation. The speed range covers -150% to +150% of the nominal speed. For the torque, 31 classes are available for the torque range from -250% to +250% of the nominal torque.

The nominal speed and nominal torque of the load matrix refer to the gear unit output of the geared motor.

The speed range includes:

$$-1.5 \times n_{2N} \text{ to } +1.5 \times n_{2N}$$

The speed is stored in rpm.

The torque range includes:

$$-2.5 \times M_{2N} \text{ to } +2.5 \times M_{2N}$$

The torque is stored in %. The reference value for the percentage torque value is C09.

Torques and speeds outside the respective specified range are assigned to the outermost class:

Values that fall below the lower limit are sorted into the lowest class. Values that exceed the upper limit are sorted into the highest class.

Scaling

The recorded speed classes are scaled as follows, with the label representing the average of the two class limits in each case:

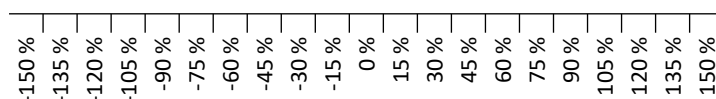

Fig. 57: Scaling of the recorded speed classes

The recorded torque classes are scaled as follows, with the label representing the average of the two class limits in each case:

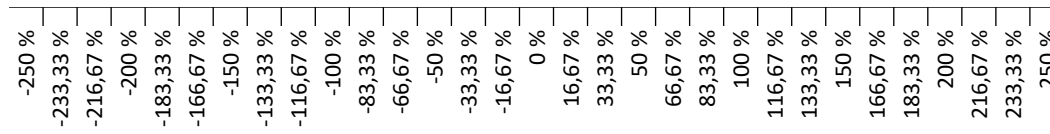

Fig. 58: Scaling of the recorded torque classes

Data export or data transmission

From the DriveControlSuite commissioning software, the load matrix can be exported in JSON data format (*.json) or in CSV data format (*.csv).

Alternatively, you can send the load matrix to STOBER for analysis (see [Reading out and transmitting the load matrix \[► 243\]](#)).

18.10.1.1 3D load matrix





The Load matrix 3D wizard shows a graphical display of the load matrix as a 3D column diagram. You can customize the display according to your needs.

3D display

Button	Role	Description
[Left mouse button]	Select	Left-clicking on a column: Selects or deselects a column in the diagram for the Zoom to button button. Selected columns are displayed in turquoise, deselected columns in blue.
[Right mouse button]	Rotate	Holding down the right mouse button anywhere on the 3D display and moving the mouse pointer: Rotates the 3D display.
[Mouse wheel]	Zoom	Turning the mouse wheel forwards or backwards anywhere on the 3D display: Enlarges or reduces the 3D display.

Toolbar of the workspace

Picklist	Option	Description
Scaling	Linear	Columns are displayed linearly scaled.
	Logarithmic	Columns are displayed logarithmically scaled.
Time basis	Seconds	Columns are shown in the respective unit.
	Minutes	
	Hours	
	Days	
	Months	
	Years	

Button	Description
	Updates the 3D display (prerequisite: online connection between DriveControlSuite and drive controller).
	Zooms in on the column when selected and rotates the display accordingly or resets the display when the column is not selected (100% scaling, standard angle).
	Reduces the size of the 3D display (zoom out).
	Sets the 3D display to 100% scaling.
	Enlarges the 3D display (zoom in).

18.10.1.2 Information on the load matrix

The load matrix is stored in DriveControlSuite in parameter R118 along with the life performance indicator in JSON data format. The parameter contains all the information necessary to understand the load matrix.

Information

For performance reasons, parameter R118 is not displayed in the parameter list of DriveControlSuite. The parameter data can be accessed indirectly via the load matrix wizard or via acyclic fieldbus communication.

Key	Value	Description
"version"	String	Version name of the JSON format
"id"	String	ID for the type of JSON document
"ds6-username"	String	User name that is entered by DriveControlSuite when exporting or sending
"ds6-email"	String	Email address that is entered by DriveControlSuite when exporting or sending
"ds6-company"	String	Company name that is entered by DriveControlSuite when exporting or sending
"ds6-comment"	String	Comment that is entered by DriveControlSuite when exporting or sending
"ds6-date"	String	Date on which the file was exported or sent
"database-id"	Number	Database ID of the parameterized geared motor
"paramodul-sn"	String	Number on the SD card (generated upon first use and acts as identification)
"encoder-type"	Number	Type of the connected encoder (0: none, 1: incremental, 2: SSI, 3: EnDat 2.x, 4: HIPERFACE, 5: Resolver, 6: EnDat 3.x)
"garmotor-type"	String	Geared motor type
"drive-controller-type"	String	Drive controller type
"reference"	String	Reference of the drive controller
"motor-type"	String	Motor type
"axis-number"	Number	Axis number (0/1)
"gear-ratio"	Number	Gear ratio of the geared motor
"operating-time-h"	Number	Hour value of the operating time
"operating-time-m"	Number	Minute value of the operating time
"operating-time-s"	Number	Seconds value of the operating time
"motor-serial-number"	Number	Serial number of the motor
"gearbox-serial-number"	Number	Serial number of the gear unit
"encoder-serial-number"	Number	Encoder serial number
"drive-production-number"	Number	Production number of the drive controller according to nameplate (S/N)
"t-reference"	Number	Reference torque for "t-average" and "t-limits"
"t-reference-unit"	String	Unit of reference torque for "t-average" and "t-limits"
"t-limits"	Array of numbers	Load matrix: upper limits of the torque classes
"t-limit-unit"	String	Load matrix: unit of the upper limits of the torque classes
"n-limits"	Array of numbers	Load matrix: upper limits of the speed classes

Key	Value	Description
"n-limit-unit"	String	Load matrix: unit of the upper limits of the speed classes
"t-average"	Array of numbers	Load matrix: mean value of the class limits of the torque classes
"t-average-unit"	String	Load matrix: unit of the mean value of the class limits of the speed classes
"n-average"	Array of numbers	Load matrix: mean value of the class limits of the speed classes
"n-average-unit"	String	Load matrix: unit of the mean value of the class limits of the torque classes
"t-bucket-count"	Number	Load matrix: number of torque classes
"n-bucket-count"	Number	Load matrix: number of speed classes
"time-resolution"	String	Load matrix: resolution
"m2>m2not-counter"	Number	Number of times 90% of the maximum emergency off torque was exceeded M_{2NOT}
"garmotor-run-time"	Number	Operating time of the geared motor
"garmotor-run-time-unit"	Number	Unit for the operating time of the geared motor
"life-work-indicator"	Number	Value of the life performance indicator
"load-matrix"	Array of numbers	Two-dimensional array containing the load matrix; torque is applied to the rows and speed to the columns

Tab. 171: Information on the load matrix

The following characters or control characters are not allowed in the values of the load matrix:

Symbol	Description
"	Quotation marks
\	Backslash
\b	Backspace
\f	Form feed
\n	Line feed
\r	Carriage return
\t	Horizontal tab character

Tab. 172: Load matrix: Impermissible characters or control characters

18.10.1.3 Example of a load matrix in JSON format

The following example shows a load matrix in JSON format.

```
{
  "version": "1.1",
  "id": "LoadMatrix",
  "ds6-username": "unknown-username",
  "ds6-email": "unknown-email",
  "ds6-company": "unknown-company",
  "ds6-comment": "unknown-comment",
  "ds6-date": "unknown-date",
  "database-id": 3156,
  "paramodul-sn": "123456789123",
  "encoder-type": 3,
  "garmotor-type": "PH932_0400",
  "drive-controller-type": "SD6A36",
  "reference": "T1",
  "motor-type": "EZ805U",
  "axis-number": 0,
  "gear-ratio": 40.0,
  "operating-time-h": 129,
  "operating-time-m": 13,
  "operating-time-s": 24,
  "motor-serial-number": 123456789,
  "gearbox-serial-number": 123456789,
  "encoder-serial-number": 123456789,
  "drive-production-number": 1234567,
  "t-reference": 2644.0,
  "t-reference-unit": "Nm",
  "t-limits": [-2.417, -2.250, -2.083, -1.917, -1.750, -1.583, -1.417, -1.250,
    -1.083, -0.917, -0.750, -0.583, -0.417, -0.250, -0.083, 0.083, 0.250, 0.417, 0.583,
    0.750, 0.917, 1.083, 1.250, 1.417, 1.583, 1.750, 1.917, 2.083, 2.250, 2.417,
    2.583],
  "t-limit-unit": "%",
  "n-limits": [-71.250, -63.750, -56.250, -48.750, -41.250, -33.750, -26.250,
    -18.750, -11.250, -3.750, 3.750, 11.250, 18.750, 26.250, 33.750, 41.250, 48.750,
    56.250, 63.750, 71.250, 78.750],
  "n-limit-unit": "rpm",
  "t-average": [-2.500, -2.333, -2.167, -2.000, -1.833, -1.667, -1.500, -1.333,
    -1.167, -1.000, -0.833, -0.667, -0.500, -0.333, -0.167, 0.000, 0.167, 0.333, 0.500,
    0.667, 0.833, 1.000, 1.167, 1.333, 1.500, 1.667, 1.833, 2.000, 2.167, 2.333,
    2.500],
  "t-average-unit": "%",
  "n-average": [-75.000, -67.500, -60.000, -52.500, -45.000, -37.500, -30.000,
    -22.500, -15.000, -7.500, 0.000, 7.500, 15.000, 22.500, 30.000, 37.500, 45.000,
    52.500, 60.000, 67.500, 75.000],
  "n-average-unit": "rpm",
  "t-bucket-count": 31,
  "n-bucket-count": 21,
  "time-resolution": "1us",
  "m2>m2not-counter": 0,
  "garmotor-run-time": 0,
  "garmotor-run-time-unit": "s",
  "life-work-indicator": 0.000280,
  "load-matrix": [
    [0, 0, 0, 0, 0, 0, 0, 0, 0, 0, 0, 0, 0, 0, 0, 0, 0, 0, 0, 0, 0],
    [0, 0, 0, 0, 0, 0, 0, 0, 0, 0, 0, 0, 0, 0, 0, 0, 0, 0, 0, 0, 0],
    [0, 0, 0, 0, 0, 0, 0, 0, 0, 0, 0, 0, 0, 0, 0, 0, 0, 0, 0, 0, 0],
    [0, 0, 0, 0, 0, 0, 0, 0, 0, 0, 0, 0, 0, 0, 0, 0, 0, 0, 0, 0, 0],
    [0, 0, 0, 0, 0, 0, 0, 0, 0, 0, 0, 0, 0, 0, 0, 0, 0, 0, 0, 0, 0],
    [0, 0, 0, 0, 1000, 3000, 4000, 4000, 3000, 4000, 1000, 0, 0, 0, 0, 0, 0, 0, 0, 0, 0, 0],
    [0, 0, 0, 0, 0, 0, 0, 0, 0, 0, 0, 0, 0, 0, 0, 0, 0, 0, 0, 0, 0],
    [0, 0, 0, 0, 0, 0, 0, 0, 0, 0, 2000, 4000, 4000, 3000, 4000, 3000, 0, 0, 0, 0, 0],
    [0, 0, 0, 0, 0, 0, 0, 0, 0, 0, 0, 0, 0, 0, 0, 0, 0, 0, 0, 0, 0],
    [0, 0, 0, 0, 0, 0, 0, 0, 0, 0, 0, 0, 0, 0, 0, 0, 0, 0, 0, 0, 0],
    [0, 0, 0, 0, 0, 0, 0, 0, 0, 0, 0, 0, 0, 0, 0, 0, 0, 0, 0, 0, 0],
    [0, 0, 0, 0, 0, 0, 0, 0, 0, 0, 0, 0, 0, 0, 0, 0, 0, 0, 0, 0, 0]
  ]
}
```

```
[0, 0, 0, 0, 0, 0, 0, 0, 0, 0, 0, 0, 0, 0, 0, 0, 0, 0, 0, 0],
[0, 0, 0, 0, 0, 0, 0, 0, 0, 0, 0, 0, 0, 0, 0, 0, 0, 0, 0, 0],
[0, 0, 0, 0, 20000, 0, 0, 0, 0, 0, 0, 0, 0, 0, 0, 0, 0, 0, 0, 0],
[0, 0, 0, 0, 0, 0, 0, 0, 0, 0, 41000, 0, 0, 0, 0, 0, 0, 0, 0, 0],
[0, 0, 0, 0, 0, 0, 0, 0, 0, 0, 0, 0, 0, 0, 20000, 0, 0, 0, 0, 0],
[0, 0, 0, 0, 0, 0, 0, 0, 0, 0, 0, 0, 0, 0, 0, 0, 0, 0, 0, 0],
[0, 0, 0, 0, 0, 0, 0, 0, 0, 0, 0, 0, 0, 0, 0, 0, 0, 0, 0, 0],
[0, 0, 0, 0, 0, 0, 0, 0, 0, 0, 0, 0, 0, 0, 0, 0, 0, 0, 0, 0],
[0, 0, 0, 0, 0, 0, 0, 0, 0, 0, 0, 0, 0, 0, 0, 0, 0, 0, 0, 0],
[0, 0, 0, 0, 0, 0, 0, 0, 0, 0, 0, 0, 0, 0, 0, 0, 0, 0, 0, 0],
[0, 0, 0, 0, 0, 3000, 4000, 4000, 3000, 4000, 2000, 0, 0, 0, 0, 0, 0, 0, 0, 0],
[0, 0, 0, 0, 0, 0, 0, 0, 0, 0, 0, 0, 0, 0, 0, 0, 0, 0, 0, 0],
[0, 0, 0, 0, 0, 0, 0, 0, 0, 0, 1000, 4000, 4000, 3000, 4000, 3000, 1000, 0, 0, 0, 0],
[0, 0, 0, 0, 0, 0, 0, 0, 0, 0, 0, 0, 0, 0, 0, 0, 0, 0, 0, 0],
[0, 0, 0, 0, 0, 0, 0, 0, 0, 0, 0, 0, 0, 0, 0, 0, 0, 0, 0, 0],
[0, 0, 0, 0, 0, 0, 0, 0, 0, 0, 0, 0, 0, 0, 0, 0, 0, 0, 0, 0],
[0, 0, 0, 0, 0, 0, 0, 0, 0, 0, 0, 0, 0, 0, 0, 0, 0, 0, 0, 0],
]
```

18.10.1.4 Memory requirement of the load matrix

The maximum required memory space is 16 KiB (Kibibyte) per load matrix in JSON format.

The load matrix is saved separately for each axis and in duplicate to prevent data loss. Consequently, the maximum required memory space is 32 KiB on the SD card of a single-axis controller and 64 KiB on the SD card of a double-axis controller.

When a geared motor is replaced by a new geared motor, new JSON files are generated for it. Accordingly, the required memory space for each new geared motor increases by a maximum of 32 KiB.

The required memory space per day depends on the application, but is within the maximum required memory space.

18.10.1.5 Export of the load matrix

You can export the load matrix as a JSON or CSV file.

The load matrix in JSON format is particularly suitable for simple evaluation, comparison and display of the load matrix using programming languages such as Python, C#, C++ or Java and for use in IIoT applications.

The load matrix in CSV format can be displayed and evaluated as a diagram using spreadsheet programs such as Microsoft Excel.

18.10.1.5.1 Load matrix in JSON format

The data of the load matrix in JSON format corresponds to the data of parameter R118.

For information on the individual elements, see [Information on the load matrix](#) [▶ 235].

Evaluation

The data in the JSON file can be analyzed as a diagram using Python and Matplotlib.

Prerequisites:

- Python programming language in V 3.0 or later
- Matplotlib program library in V 1.0.0 or later
- NumPy program library in V 1.0.0 or later

Example

```
# Import required libraries
import json
import matplotlib.pyplot as plt
import numpy as np

# File path for the JSON file
file_path = r"C:\Temp\LoadMatrix_20230912_095707.json"

# Open and read data from the JSON file
with open(file_path, 'r') as file:
    data = json.load(file)

# Create a 3D plot
fig, ax = plt.subplots(subplot_kw={"projection": "3d"})

# Extract and prepare data from the JSON file
speeds = np.array(data["n-average"])
torques = np.array(np.multiply(data["t-average"], data["t-reference"]))

# Set axis labels
ax.set(ylabel="torque in Nm", xlabel="speed in rpm", zlabel="amount in min")

# Define the number of ticks on the axes
plt.locator_params(axis='x', nbins=data["n-bucket-count"])
plt.locator_params(axis='y', nbins=data["t-bucket-count"])

# Prepare data for the 3D surface
speeds, torques = np.meshgrid(speeds, torques)
loads_us = np.array(data["load-matrix"])
loads_minutes = np.divide(loads_us, 1000 * 1000 * 60)

# Draw the 3D surface
ax.plot_surface(speeds, torques, loads_minutes, cmap=plt.cm.coolwarm, linewidth=0,
               antialiased=True)

# Display the plot
plt.show()
```

Information

If copying and pasting the example, correct the syntax indentation after pasting if necessary.

18.10.1.5.2 Load matrix in CSV format

The CSV file contains the Metadata and Load-Matrix sections.

For information on the individual elements, see [Information on the load matrix \[▶ 235\]](#).

Metadata

The metadata includes all the information required to identify the axis within the machine. It also contains information on the operating time of the axis, the serial numbers of motor, gear unit and encoder components, and the production number of the drive controller. The axis labels of the load matrix, the units in which the load matrix is recorded, and the life performance indicator can also be found in the metadata.

Load-Matrix

The Load-Matrix section contains the data and axis labels of the load matrix. The speed axis label is in the first row after `Start Load-Matrix`; the torque axis label follows in the first column. The speeds can be found in the line `n-average` and the corresponding unit in the line `n-average-unit`. The torques are the result of multiplying `t-average` and `t-reference`. The corresponding unit can be found in the line `t-reference-unit`.

Evaluation

Proceed as follows to create a 3D column chart in Microsoft Excel from the load matrix data:

1. Open the CSV file in Excel.
 2. Select all cells with content between the rows `Start Load-Matrix` and `End Load-Matrix`.
 3. On the **Insert** tab, select **Charts > Insert column or bar chart > 3D column**.
- ⇒ The 3D column diagram is inserted.

18.10.2 Life performance indicator

The life performance indicator is the value for the calculated life performance of the geared motor. No additional external sensor is required to determine it. In DriveControlSuite, the life performance indicator is displayed in the Predictive Maintenance wizard (R101). Values below 100% mean that the geared motor is being operated within its life performance. For values above 100%, the probability of failure increases. From a value of 90%, it is recommended to replace the geared motor and a corresponding message is output in parameter R100.

Information

Increasing values do not mean that there is damage to the geared motor. Operation of the geared motor is also possible at values > 100%.

Information

The life performance indicator is calculated and updated only if the axis is enabled (A900 = 1).

The life performance indicator increases monotonically: faster with greater load, slower with lesser load.

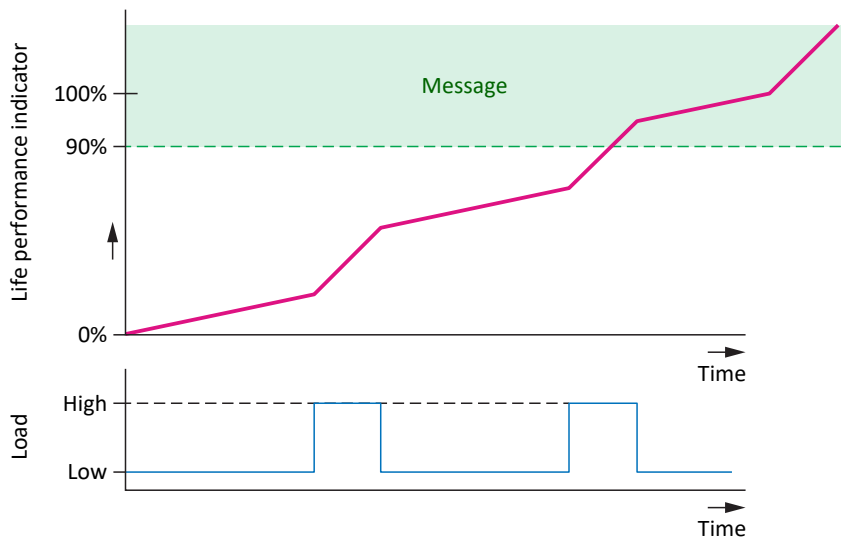

Fig. 59: Signaling area

The algorithm for the life performance indicator is continuously being further developed.

18.10.3 Update and storage cycles

The action A00 Save values has no influence on the saving of Predictive Maintenance data.

Load matrix

The load matrix is stored in non-volatile memory on the SD card along with the life performance indicator every 30 minutes.

The data for the load matrix (speeds and torques) is sampled with the cycle time set in A150.

In the drive controller, the load matrix is updated with the cycle time set in A150.

If the drive controller is switched off before the load matrix data is automatically saved every 30 minutes, the data will be lost.

Life performance indicator

The life performance indicator is stored in non-volatile memory in the drive controller every 10 minutes, and on the SD card together with the load matrix every 30 minutes.

The value of the life performance indicator is updated in the drive controller twice per minute.

Unlike for the load matrix, an SD card is not absolutely necessary for the life performance indicator because of the non-volatile storage in the drive controller.

18.10.4 Recommendation for geared motor replacement

The recommendation to replace the geared motor is displayed in DriveControlSuite in the Predictive Maintenance wizard (R100). The recommendation is triggered when Predictive Maintenance is active and the life performance indicator reaches a value $\geq 90\%$ (R101).

18.10.5 Reading out and transmitting the load matrix

Would you like to know more about the real-world load situation of your machine and its optimization potential? Would you like to support the further development of our algorithm? If you send us your load matrix, we will help you in analyzing or visualizing your data. We will also be able to take your specific machine behavior into consideration for further development.

Information

It is not possible to infer specific machine cycles based on the load matrix. The load matrix contains only highly condensed, statistical features.

Reading out data

The following graphic describes the 3 options for reading out the data.

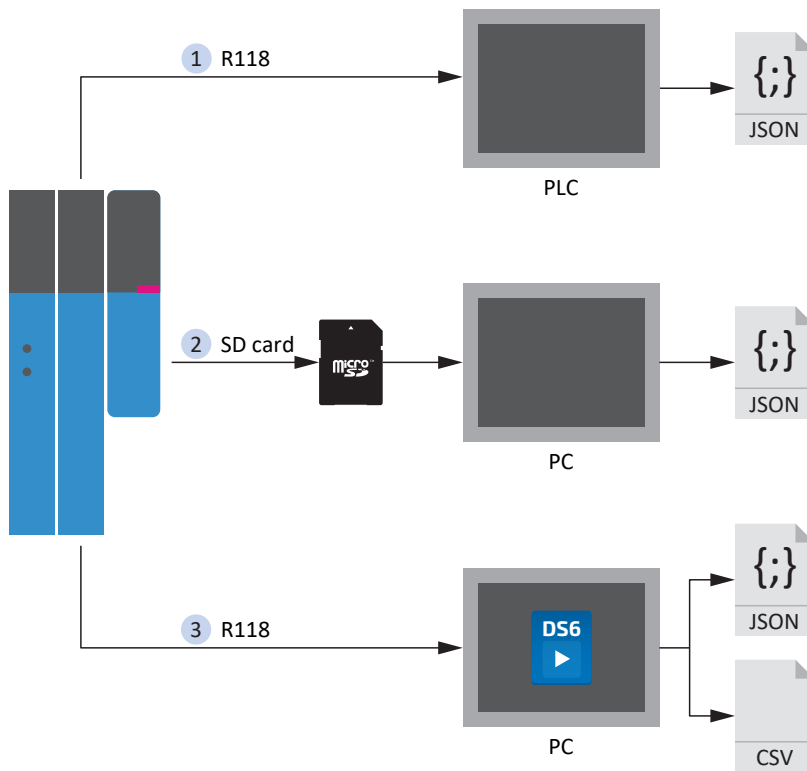

Fig. 60: Predictive Maintenance: Options for readout

1. Via the controller (in preparation)

Function blocks for controllers are in preparation that will enable the controller to read the parameter R118 and write the data to a JSON file.

2. From the SD card

You can read out the data on your PC directly from the SD card.

The JSON files are stored in the following form:

- If a serial number is available for the motor, it is used for the file name.
- If no serial number is available for the motor, the file name consists of 8 characters (hexadecimal) which are generated from the CRC checksum of B00.

File name	Example
PRM\[Serial number].PXX	03774434.P00
PRM\[8 characters].PXX	0BB5A846.P00

Tab. 173: Predictive Maintenance files on SD card

To avoid data loss, the files are each stored twice on the SD card.

The file extensions have the following meaning:

File extension	Meaning
P00	JSON for axis A
P01	JSON for axis A (backup file)
P10	JSON for axis B
P11	JSON for axis B (backup file)

Tab. 174: Meaning of file extensions on SD card

3. Via DriveControlSuite

Use the associated wizard in DriveControlSuite to export the load matrix. For the export, parameter R118 is read out from the drive controller directly if an online connection exists or from your project in offline mode.

Transmitting the data

You can provide the data to STOBER via upload through DriveControlSuite or by email to prm_data@stober.de.

19 Diagnostics

LEDs on the top and front give you initial information about the device state as well as the states of the physical connection and the communication. In the event of an error or fault, you will receive detailed information through the DriveControlSuite commissioning software.

19.1 Drive controllers

The drive controllers have diagnostic LEDs that visually indicate the state of the drive controller as well as the states of the physical connection and communication.



Fig. 61: Positions of the diagnostic LEDs on the front and top of the drive controller

- 1 Fieldbus state
- 2 FSoE or PROFIsafe state
- 3 Drive controller state
- 4 Service network connection
- 5 Fieldbus network connection

19.1.1 Drive controller state

3 LEDs on the front of the device provide information about the state of the drive controller.

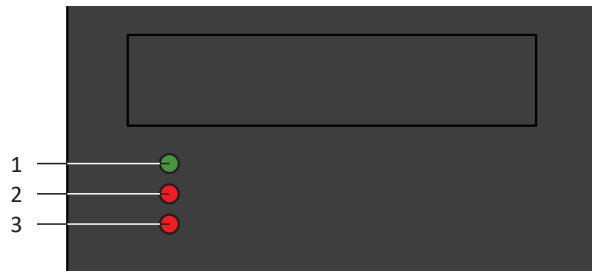











Fig. 62: LEDs for the state of the drive controller

- 1 Green: Run
- 2 Red: Axis A error
- 3 Red: Axis B error (double-axis controller)

Green LED	Conduct	Description
	Off	No supply voltage, axis A or B has a fault or STO for axis A or B active
	Single flash	With firmware version 6.6-A or later: Self-test (E48 = 0: Self test); SX6: Duration of the self-test depends on the operational readiness of the safety module Up to firmware version 6.5-G: STO active (double-axis controller: STO active for both axes)
	Flashing	Both axes ready to switch on (E48 = 2: Ready for switch-on); no axis has a fault; STO not active for any axis
	On	At least 1 axis enabled (E48 = 4: Enabled); no axis has a fault; STO not active for any axis
	Rapid flashing	Data are written to internal memory and the SD card
	Triple flash	Safety activation, step 3: Safety configuration is saved in the safety module
	Double flash	Safety activation, step 4: Activation of safety configuration successfully completed; switch to regular operating display by pressing the operating button or automatically after 30 s



Tab. 175: Meaning of the green LED (Run)

Red LED	Conduct	Description
	Off	No error or event
	Single flash	With firmware version 6.5-H or later: STO active for axis A or B
	Double flash	Device start-up with different safety configuration in the safety module and on the SD card: Safety activation required (see also Commissioning the new drive controller after replacing the device [▶ 340]); Safety activation, step 1: Press and hold operating button S1 within 30 s
	Double flash, inverse	Safety activation, step 2: Press and hold operating button S1 for approx. 2-5 s
	Triple flash	Safety activation, step 3: Safety configuration is saved in the safety module
	Flashing	Axis A or B has a warning
	On	Axis A or B has a fault
	Single flash, inverse	With firmware version 6.5-H or later: Axis A or B has a fault; STO active
	Rapid flashing	No configuration active

Tab. 176: Meaning of the red LEDs (error)

Pattern when starting the drive controller



When the drive controller is started, all 3 LEDs flash as follows:

LEDs: Green/Red/Red	Conduct	Description
	On	Short phase while the firmware starts up
	On	
	On	

Tab. 177: States of the LEDs when starting the drive controller

Pattern for identifying the drive controller (DS6 online function)













You can access the Online functions window in DriveControlSuite after you have established a connection between DriveControlSuite and the drive controller in the Add connection dialog box. The  button lets the LEDs on the front panel of the drive controller flash to make identification in the network easier. With single-axis controllers, the green and red LEDs flash; with double-axis controllers, all 3 LEDs flash:

LEDs: Green/Red/Red	Conduct	Description
	Rapid flashing	Identifying the drive controller in the network
	Rapid flashing	
	Rapid flashing	

Tab. 178: States of the LEDs when identifying the drive controller in the network

Pattern when transferring a firmware file using an SD card









When a firmware file is being transferred using an SD card, all 3 LEDs flash in various combinations and frequencies:

LEDs: Green/Red/Red	Conduct	Description
	Off	Deleting the 2nd firmware memory on the drive controller
	Rapid flashing	
	Off	
	Rapid flashing	Copying the firmware from the SD card to the 2nd firmware memory of the drive controller
	Rapid flashing	
	Rapid flashing	
	Single blink	Copying process completed successfully; drive controller has to be restarted
	Off	
	Off	
	Off	Error during copying process; remove card and restart drive controller
	Single blink	
	Off	

Tab. 179: States of the LEDs when using an SD card to transfer a firmware file

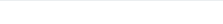
Pattern after transferring a firmware file and restarting the drive controller

During a firmware update after restarting the drive controller, all three LEDs flash in various combinations and frequencies:

LEDs: Green/Red/Red	Conduct	Description
	Off	Deleting the 1st firmware memory
	Rapid flashing	
	Off	
	Rapid flashing	Copying the 2nd firmware memory into the 1st
	Off or On (depending on FW size)	
	Off	
	Chaser light	Error during firmware update; service required
		
		

Tab. 180: States of the LEDs after transferring a firmware file and restarting the drive controller

19.1.2 State of the fieldbus and safety technology

The LEDs for diagnosing the fieldbus state and the safety technology vary depending on the fieldbus system and safety module used.

19.1.2.1 EtherCAT state

The 2 LEDs on the front of the drive controller provide information about the connection between the EtherCAT MainDevice and SubDevice and the state of the data exchange. This information can also be read out in parameter A255.

If the drive controller includes the SX6 or SY6 safety module, the safety functions are controlled using EtherCAT FSoE. In this case, an additional LED on the front of the device provides information about the FSoE state.

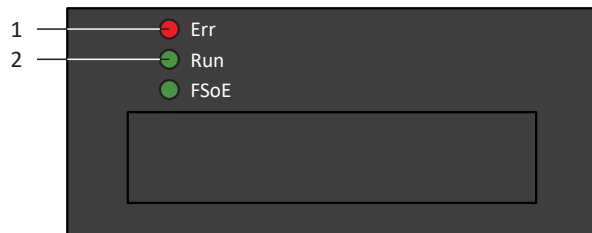

Fig. 63: LEDs for the EtherCAT state

- 1 Red: Error
- 2 Green: Run

Red LED	Conduct	Error	Description
	Off	No Error	No error
	Flashing	Invalid Configuration	Invalid configuration
	Single flash	Unsolicited State Change	The EtherCAT SubDevice changed operating states by itself
	Double flash	Application Watchdog Timeout	The EtherCAT SubDevice did not receive new PDO data during the configured watchdog timeout
	On	Application controller failure	Internal device communication error; switch device off and on again

Tab. 181: Meaning of the red LED (error)

Green LED	Conduct	Operating state	Description
	Off	Init	No communication between the EtherCAT MainDevice and SubDevice; the configuration starts, saved values are loaded
	Flashing	Pre-operational	No PDO communication; the EtherCAT MainDevice and SubDevice exchange application-specific parameters via SDOs
	Single flash	Safe-operational	The EtherCAT SubDevice sends the current actual values to the EtherCAT MainDevice, ignores its set values and refers to internal default values
	On	Operational	Normal operation: The EtherCAT MainDevice and SubDevice exchange set and actual values

Tab. 182: Meaning of the green LED (Run)

19.1.2.2 FSoE state (option SY6)

If the drive controller includes the SY6 safety module, the STO and SS1 safety functions are controlled using EtherCAT FSoE. In this case, an LED on the front of the device provides information about the state of FSoE communication. This information can also be read out in parameter S20 FSoE status indicator.



Fig. 64: LED for the FSoE state

1 Green: FSoE

Green LED	Conduct	Description
	Off	Initialization
	Flashing	Ready for parameterization
	On	Normal operation
	Single flash	Failsafe command from FSoE MainInstance received
	Rapid flashing	Undefined connection error
	Rapid flashing with 1x flash	Error in the safety-related communication settings
	Rapid flashing with 2x flash	Error in the safety-related application settings
	Rapid flashing with 3x flash	Incorrect FSoE address
	Rapid flashing with 4x flash	Prohibited command received
	Rapid flashing with 5x flash	Watchdog error
	Rapid flashing with 6x flash	CRC error

Tab. 183: Meaning of the green LED (FSoE status indicator in accordance with IEC 61784-3)

19.1.2.3 FSoE state (option SX6)

If the drive controller includes the SX6 safety module, the safety functions are controlled using EtherCAT FSoE. In this case, an LED on the front of the device provides information about the state of FSoE communication. This information can also be read out in parameter S20 FSoE status indicator.



Fig. 65: LED for the FSoE state

1 Green: FSoE

Green LED	Conduct	Description
	Off	No communication
	Single flash	Establishing FSoE communication, transfer of FSoE parameters
	Rapid flashing	FSoE link active, FSoE connection in RESET state
	Flashing	Communication active
	On	Communication active, transfer of process data

Tab. 184: Meaning of the green LED

19.1.2.4 PROFINET state

There are 2 LEDs on the front of the drive controller that provide information about the connection between controller and drive controller and about the state of the data exchange. This information can also be read out in parameter A271 PN state.



Fig. 66: LEDs for the PROFINET state

- 1 Red: BF (bus error)
- 2 Green: Run

Red LED	Conduct	Description
	Off	No error
	Rapid flashing	Data exchange with controller not active
	On	No network connection

Tab. 185: Meaning of the red LED (BF)

Green LED	Conduct	Description
	Off	No connection
	Single blink	Connection is set up to controller
	Single blink, inverse	Controller activates DHCP signal service
	Flashing	Existing connection to controller; data exchange expected
	On	Existing connection to controller

Tab. 186: Meaning of the green LED (Run)

19.1.2.5 PROFIsafe status

If the drive controller includes the SU6 safety module, the STO and SS1 safety functions are activated via PROFIsafe. In this case, an LED on the front of the device provides information about the status of PROFIsafe communication. This information can also be read out in parameter S40 PROFIsafe state.



Fig. 67: LED for the PROFIsafe state

1 Green: PROFIsafe

Green LED	Conduct	Description
	Off	Initialization
	Flashing	Ready for parameterization by controller (F-CPU)
	On	Normal operation
	Rapid flashing with 1x flash	Error in the safety-related communication settings
	Rapid flashing with 2x flash	Error in the safety-related application settings
	Rapid flashing with 3x flash	Incorrect PROFIsafe destination address
	Rapid flashing with 5x flash	Interruption of the PROFIsafe connection (watchdog error)
	Rapid flashing with 6x flash	Error in the transmission of the PROFIsafe data (CRC error)

Tab. 187: Meaning of the green LED (PROFIsafe status indicator in accordance with IEC 61784-3)

Information

Parameter S40 PROFIsafe state contains detailed information about the PROFIsafe communication status. The value of S40 can be read off in PROFINET wizard > Monitoring: PROFIsafe in DriveControlSuite.

19.1.3 Service network connection

The LEDs at X9 on the front of the device display the state of the service network connection.

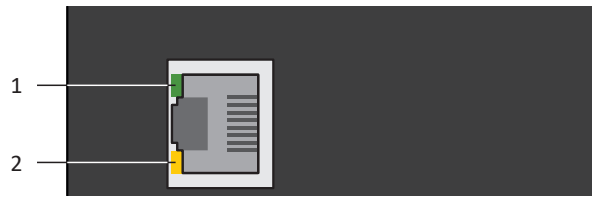







Fig. 68: LEDs for the state of the service network connection

- 1 Green: Link
- 2 Yellow: Activity

Green LED	Behavior	Description
	Off	No network connection
	On	Network connection present

Tab. 188: Meaning of the green LED (link)

Yellow LED	Behavior	Description
	Off	No network connection
	Flashing	Individual data packets are sent or received
	On	Active data exchange

Tab. 189: Meaning of the yellow LED (act.)

19.1.4 Fieldbus network connection

The LEDs for communication diagnostics vary depending on implemented fieldbus system or communication module.

19.1.4.1 EtherCAT network connection

The LEDs LA_{EC}IN and LA_{EC}OUT at X200 and X201 on the top of the device indicate the state of the EtherCAT network connection.

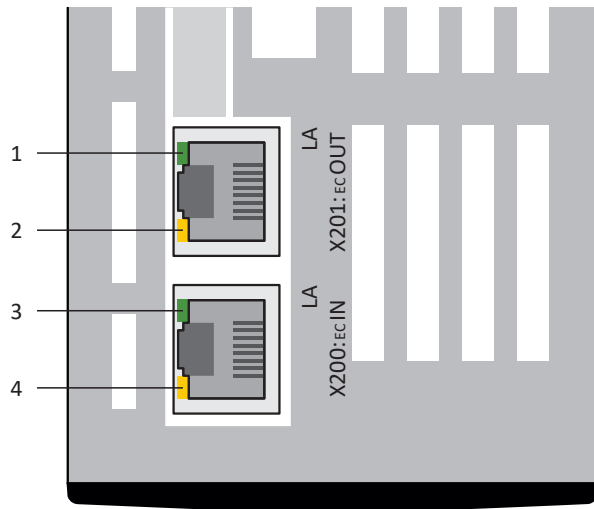

Fig. 69: LEDs for the state of the EtherCAT network connection

- 1 Green: LA_{EC}OUT at X201
- 2 Yellow: No function
- 3 Green: LA_{EC}IN at X200
- 4 Yellow: No function

Green LED	Behavior	Description
	Off	No network connection
	Flashing	Active data exchange with other EtherCAT nodes
	On	Network connection exists

Tab. 190: Meaning of the green LEDs (LA)

19.1.4.2 PROFINET network connection

The Act. and Link LEDs at X200 and X201 on the top of the device indicate the state of the PROFINET network connection.

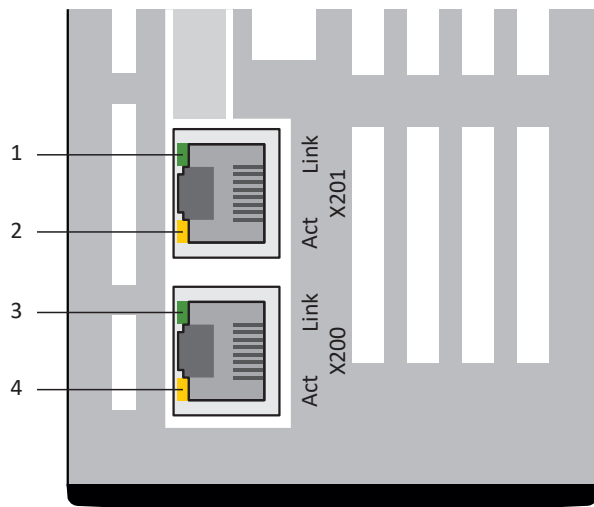





Fig. 70: LEDs for the state of the PROFINET network connection

- 1 Green: Link at X201
- 2 Yellow: Activity at X201
- 3 Green: Link at X200
- 4 Yellow: Activity at X200

Green LED	Conduct	Description
	Off	No network connection
	On	Network connection exists

Tab. 191: Meaning of the green LEDs (Link)

Yellow LED	Conduct	Description
	Off	No data exchange
	Flashing	Active data exchange with controller

Tab. 192: Meaning of the yellow LEDs (Act.)

19.1.5 Events

The drive controller has a self-monitoring system that uses test rules to protect the drive system from damage. Violating the test rules triggers a corresponding event. There is no possible way for you as the user to intervene in some events, such as the Short/ground event. In others, you can influence the effects and responses.

Possible effects include:

- **Message:** Information that can be evaluated by the controller
- **Warning:** Information that can be evaluated by the controller and becomes a fault after a defined time span has elapsed without the cause being resolved
- **Fault:** Immediate drive controller response; the power unit is disabled and axis movement is no longer controlled by the drive controller or the axis is brought to a standstill by a quick stop or emergency braking

Depending on the event, there are various measures you can take to rectify the cause. As soon as the cause has been successfully rectified, you can usually acknowledge the event immediately. If the drive controller has to be restarted, a corresponding note can be found in the measures.

ATTENTION!

Damage to property due to interruption of a quick stop or emergency braking!

If, when executing a quick stop or emergency braking, a fault occurs or STO is active, the quick stop or emergency braking is interrupted. In this case, the machine can be damaged by the uncontrolled axis movement.

Information

To make it easier for control programmers to set up the human-machine interface (HMI), a list of events and their causes can be found in the STOBER download center at <http://www.stoerber.de/en/downloads/> by searching for `Events`.

19.1.5.1 Overview

The following table shows the possible events at a glance.

Event
Event 31: Short/ground [▶ 260]
Event 32: Short/ground internal [▶ 261]
Event 33: Overcurrent [▶ 262]
Event 34: Hardware fault [▶ 263]
Event 35: Watchdog [▶ 264]
Event 36: High voltage [▶ 264]
Event 37: Motor encoder [▶ 265]
Event 38: Temperature drive controller sensor [▶ 268]
Event 39: Overtemperature drive controller i2t [▶ 269]
Event 40: Invalid data [▶ 270]
Event 41: Temp.MotorTMP [▶ 271]
Event 42: TempBrakeRes [▶ 272]
Event 44: External fault 1 [▶ 273]
Event 45: Overtemp.motor i2t [▶ 274]
Event 46: Low voltage [▶ 275]
Event 47: Torque/force-max. limit [▶ 276]
Event 48: Brake release monitoring [▶ 277]
Event 49: Brake [▶ 278]
Event 50: Safety module [▶ 279]
Event 51: Virtual master software limit switch [▶ 281]
Event 52: Communication [▶ 282]
Event 53: Limit switch [▶ 283]
Event 54: Following error [▶ 284]
Event 56: Overspeed [▶ 285]
Event 57: Runtime requirement [▶ 286]
Event 59: Overtemperature drive controller i2t [▶ 287]
Event 60: Application event 0 – Event 67: Application event 7 [▶ 288]
Event 68: External fault 2 [▶ 289]
Event 69: Motor connection [▶ 290]
Event 70: Parameter consistency [▶ 291]
Event 71: Firmware [▶ 293]
Event 76: Position encoder [▶ 294]
Event 77: Master encoder [▶ 297]
Event 78: Position limit cyclic [▶ 299]
Event 79: Motor/position encoder plausibility [▶ 300]
Event 80: Illegal action [▶ 301]
Event 81: Motor allocation [▶ 302]
Event 83: Failure of one/ all phases (mains) [▶ 303]

Event
Event 84: Drop in network voltage when power section active [▶ 304]
Event 85: Excessive jump in reference value [▶ 306]
Event 86: Unknown LeanMotor record [▶ 307]
Event 87: Reference lostReference loss [▶ 308]
Event 88: Control panel [▶ 308]
Event 89: Maximum current LM [▶ 309]
Event 90: Motion block [▶ 310]

Tab. 193: Events

19.1.5.2 Event 31: Short/ground

The drive controller has a **fault**:

- The power unit is disabled and axis movement is no longer controlled by the drive controller
- The behavior of the brakes depends on the configuration of the safety module

Information

A rising edge for the release override signal (source: F06) is expected in the Switch on disabled, Ready to switch on, and Switched on states (E48) so that the brake is released.

The brake chopper is switched off.

ATTENTION!

Material damage due to repeated activation and deactivation or new enable signal!

Repeated activation and deactivation or a new enable signal with an existing short-circuit can lead to a device fault.

- Before the new activation or enable signal, the cause must be found and corrected.

Cause	Check and action
Connection error at the motor	Check the connection and correct it if necessary
Defective power cable	Check the cable and replace it if necessary
Short-circuit in the motor winding	Check the motor and replace it if necessary
Short-circuit in the braking resistor	Check the braking resistor and replace it if necessary
Short-circuit/ground fault inside the device	Check whether the fault occurs when switching on the power unit and replace the drive controller if necessary; the fault can only be acknowledged after 30 s

Tab. 194: Event 31 – Causes and actions

19.1.5.3 Event 32: Short/ground internal

The drive controller has a **fault**:

- The power unit is disabled and axis movement is no longer controlled by the drive controller
- The behavior of the brakes depends on the configuration of the safety module

Information

A rising edge for the release override signal (source: F06) is expected in the Switch on disabled, Ready to switch on, and Switched on states (E48) so that the brake is released.

The brake chopper is switched off.

ATTENTION!

Material damage due to repeated activation and deactivation!

Repeated activation and deactivation with an existing short-circuit can lead to a device fault.

- Before the new activation or enable signal, the cause must be found and corrected.

Cause	Check and action
Short-circuit/ground fault inside the device	Replace the drive controller; the fault cannot be acknowledged

Tab. 195: Event 32 – Causes and actions

19.1.5.4 Event 33: Overcurrent

The drive controller has a **fault** if:

- U30 = 0: Inactive

Response:

- The power unit is disabled and axis movement is no longer controlled by the drive controller
- The brakes engage

The drive controller has a **fault with emergency braking** if:

- U30 = 1: Active and
- A29 = 1: Active for Drive Based or PROFIdrive device control
or
- U30 = 1: Active and
- A540 = 2: Slow down on quick stop ramp for CiA 402 device controller

Response:

- The axis is stopped by emergency braking
- The brakes engage
- At the end of emergency braking, the power unit is disabled and axis movement is no longer controlled by the drive controller

Information

Emergency braking is only possible for the synchronous servo, Lean, torque, and synchronous linear motor types.

Information

A rising edge for the release override signal (source: F06) is expected in the Switch on disabled, Ready to switch on, and Switched on states (E48) so that the brake is released.

Cause		Check and action
Switch-off condition fulfilled (E00 > R04 × R26); switch-off: <ul style="list-style-type: none"> ▪ 1: Normal (in software) ▪ 2: Fast (in hardware) 	Short acceleration times	Check the actual current using the scope image and reduce the acceleration values if necessary (E00); the fault can only be acknowledged 3 s after the cause has been corrected
	Large torque/force limits	Check the actual current using the scope image (E00) and reduce the torque/force limits if necessary (C03, C05); the fault can only be acknowledged 3 s after the cause has been corrected
	Wrong drive controller design	Check the design and change the drive controller type if necessary; the fault can only be acknowledged 3 s after the cause has been corrected
	Short-circuit/ground fault	If cause 2 occurs repeatedly, check whether there is a short-circuit/ground fault

Tab. 196: Event 33 – Causes and actions

19.1.5.5 Event 34: Hardware fault

The drive controller has a **fault**:

- The power unit is disabled and axis movement is no longer controlled by the drive controller
- The behavior of the brakes depends on the configuration of the safety module

Information

A rising edge for the release override signal (source: F06) is expected in the Switch on disabled, Ready to switch on, and Switched on states (E48) so that the brake is released.

Cause		Check and action
1: FPGA, 2: NOV control unit, 3: NOV-Power Unit, 6: NOV safety module, 7: Current measurement, 8: power supply, 9: power supply, 10: power supply, 11: power supply, 12: Timer control board	Defective drive controller	Exchange drive controller; fault cannot be acknowledged
23: FPGA, 24: FPGA, 25: FPGA, 26: CPU, 27: CPU, 28: CPU, 29: Communication	Defective drive controller	Exchange drive controller; fault cannot be acknowledged
30: power supply	Defective drive controller	Check encoder power consumption; replace defective or incorrectly selected component; fault cannot be acknowledged
	Defective encoder	
	Power output of encoder interface outside specification	

Tab. 197: Event 34 – Causes and actions

19.1.5.6 Event 35: Watchdog

The drive controller has a **fault**:

- The power unit is disabled and axis movement is no longer controlled by the drive controller
- The behavior of the brakes depends on the configuration of the safety module

Information

A rising edge for the release override signal (source: F06) is expected in the Switch on disabled, Ready to switch on, and Switched on states (E48) so that the brake is released.

The brake chopper and brake release override are non-functional while the runtime system restarts.

Cause		Check and action
1: Core 0, 2: Core 1	Microprocessor at full load	Check the runtime utilization using the scope image (E191) and reduce it using a longer cycle time if necessary (A150)
	Microprocessor faulty	Check the connection and shielding and correct them if necessary; replace the drive controller if necessary

Tab. 198: Event 35 – Causes and actions

19.1.5.7 Event 36: High voltage

The drive controller has a **fault**:

- The power unit is disabled and axis movement is no longer controlled by the drive controller
- The behavior of the brakes depends on the configuration of the safety module

Information

A rising edge for the release override signal (source: F06) is expected in the Switch on disabled, Ready to switch on, and Switched on states (E48) so that the brake is released.

Cause	Check and action
Short delay times	Check the DC link voltage during the braking operation using the scope image (E03) and, if necessary, reduce the delay values, use a (larger) braking resistor or connect a DC link
Brake chopper deactivated	Check the values of the parameterized braking resistor and correct it if necessary (A21, A22, A23)
Braking resistor connection error	Check the connection to the braking resistor and drive controller and correct them if necessary
Pulse power of the braking resistor is too low	Check that the braking resistor pulse power is suitable for the application; replace the braking resistor if necessary
Brake chopper is defective	Check the DC link voltage during the braking operation using the scope image (E03); the brake chopper is defective if the DC link voltage exceeds the on limit of the brake chopper (R31) without the DC link voltage dropping; replace the drive controller if necessary
Supply voltage exceeded	Check the supply voltage for an overrun of the permitted input voltage and adjust it if necessary

Tab. 199: Event 36 – Causes and actions

19.1.5.8 Event 37: Motor encoder

The drive controller has a **fault** if:

- U30 = 0: Inactive

Response:

- The power unit is disabled and axis movement is no longer controlled by the drive controller
- The brakes engage

The drive controller has a **fault with emergency braking** if:

- U30 = 1: Active and
- A29 = 1: Active for Drive Based or PROFIdrive device control
or
- U30 = 1: Active and
- A540 = 2: Slow down on quick stop ramp for CiA 402 device controller

Response:

- The axis is stopped by emergency braking
- The brakes engage
- At the end of emergency braking, the power unit is disabled and axis movement is no longer controlled by the drive controller

Information

Emergency braking is only possible for the synchronous servo, Lean, torque, and synchronous linear motor types.

Information

A rising edge for the release override signal (source: F06) is expected in the Switch on disabled, Ready to switch on, and Switched on states (E48) so that the brake is released.

Cause		Check and action
1: Parameter <-> encoder	Inconsistent parameterization	Compare the specification of the connected encoder to the corresponding values of the H parameters and correct them if necessary
2: Maximum speed	Exceeded encoder maximum velocity	Check the actual velocity during a movement using the scope image (I88) and adjust the permitted encoder maximum velocity if necessary (I297)
	Connection error	Check the connection and shielding and correct them if necessary
	Mass inertia ratio of load to Lean motor	Check the setting of the mass inertia ratio (C30) and reduce it if necessary
	Dynamic control of the Lean motor	Check the control settings; if necessary, reduce the gain (C31, I20) and increase the reset times (C32)
	Dynamic set values for the Lean motor	Check the dynamics of the application set values and reduce them if necessary
	Dynamic acceleration of the Lean motor	Use a scope image to check the actual velocity and shifting speed during a movement (E15, E959) and reduce the shifting filter time constant if necessary (B137)
6: X4 EnDat encoder found	Inconsistent parameterization	Compare the connected encoder to the parameterized encoder and correct it if necessary (H00)
7: X4 A track/Incremental	Connection error	Check the connection and correct it if necessary
8: X4 no encoder found	Connection error	Check the connection and correct it if necessary
	Defective encoder cable	Check the cable and replace it if necessary
	Faulty supply voltage	Check the supply voltage of the encoder and correct if necessary
	Inconsistent parameterization	Compare the connected encoder to the parameterized encoder and correct it if necessary (H00)
10: X4 A track/Ck, 11: X4 B track/Dat	Defective encoder cable	Check the cable and replace it if necessary
13: X4-EnDat alarm	Defective EnDat encoder	Replace the motor; EnDat 2.1 digital, EnDat 2.2 digital, EnDat 3: Fault cannot be acknowledged
14: X4 EnDat CRC, 15: X4 double transmission	Connection error	Check the connection and correct it if necessary
	Electromagnetic interference	Take EMC recommendations into account [► 104] and, if necessary, increase the fault tolerance (B298)
16: X4 busy	Synchronization error	Update firmware
17: EBI encoder low battery	Battery in battery module weak	Replace the battery; reference remains intact
18: EBI encoder battery empty	Battery in battery module empty	Replace the battery
	Initial connection	–
	Connection error	Check the connection and correct it if necessary
	Defective encoder cable	Check the cable and replace it if necessary
	Faulty battery module	Check the battery module and replace it if necessary
19: Alarm bit	Encoder fault	Check the specification of the encoder regarding the alarm bit

Cause		Check and action
20: Resolver carrier, 21: Resolver sin/cos undervoltage, 22: Resolver sin/cos overvoltage	Defective encoder cable	Check the cable and replace it if necessary
	Incompatible encoder	Compare the specification of the encoder with the corresponding specifications from STOBER and replace the encoder or motor if necessary; fault cannot be acknowledged
21: Resolver sin/cos undervoltage	Incompatible encoder; phase search or calibration of the optimal resolver excitation failed	Compare the specification of the encoder with the corresponding specifications from STOBER; if necessary, calibrate the starting point for calibrating the optimal resolver excitation and the phase search (B40); fault cannot be acknowledged
24: Resolver failure	Defective encoder cable	Check the cable and replace it if necessary
48: X4 zero pulse missing	Defective encoder cable	Check the cable and replace it if necessary
	Connection error	Check the connection and correct it if necessary
	Late zero track	Check number of encoder increments per rotation and correct it if necessary (H02)
49: X4 zero pulse distance too small	Defective encoder cable	Check the cable and replace it if necessary
	Connection error	Check the connection and correct it if necessary
	Early zero track	Check number of encoder increments per rotation and correct it if necessary (H02)
60: Hiperface synchronisation, 61: Hiperface timeout, 62: Hiperface signal quality, 63: Hiperface link	Defective encoder cable	Check the cable and replace it if necessary
	Connection error	Check the connection and correct it if necessary
	Electromagnetic interference	Take EMC recommendations into account [► 104] and, if necessary, increase the fault tolerance (B298)
64: EnDat3 Timeout, 65: EnDat3 invalid Request, 66: EnDat3 Position Check	Defective encoder cable	Check the cable and replace it if necessary
	Connection error	Check the connection and correct it if necessary
	Electromagnetic interference	Take EMC recommendations into account [► 104] and, if necessary, increase the fault tolerance (B298)

Tab. 200: Event 37 – Causes and actions

19.1.5.9 Event 38: Temperature drive controller sensor

The drive controller has a **fault** if:

- A29 = 0: Inactive for Drive Based or PROFIdrive device control
or
- A540 = 0: Disable drive motor coasting for CiA 402 device controller

Response:

- The power unit is disabled and axis movement is no longer controlled by the drive controller
- The brakes engage

The drive controller has a **fault with a quick stop** if:

- A29 = 1: Active for Drive Based or PROFIdrive device control
or
- A540 = 2: Slow down on quick stop ramp for CiA 402 device controller

Response:

- The axis is stopped by a quick stop
- During the quick stop, the brakes remain released
- At the end of the quick stop, the power unit is disabled and axis movement is no longer controlled by the drive controller
- The brakes engage

Information

A rising edge for the release override signal (source: F06) is expected in the Switch on disabled, Ready to switch on, and Switched on states (E48) so that the brake is released.

Cause	Check and action
Surrounding temperatures too high or too low	Check the surrounding temperature of the drive controller and adjust it to the operating conditions of the drive controller if necessary; the fault can only be acknowledged 30 s after the cause has been corrected
Too little air circulation in the control cabinet	Check the minimum clearances and adjust them if necessary; the fault can only be acknowledged 30 s after the cause has been corrected
Defective or blocked fan	Switch on control unit supply; check that the fan starts and replace the drive controller if necessary; the fault can only be acknowledged 30 s after the cause has been corrected
Assembly protection film	Remove the assembly protection film
Wrong drive controller design	Check the design and change the drive controller type if necessary; the fault can only be acknowledged 30 s after the cause has been corrected
Increased or reduced mechanical friction	Check the service status of the mechanical system of all axes and service them if necessary; the fault can only be acknowledged 30 s after the cause has been corrected
Mechanical block	Check the output of all axes and remove the block if necessary
Short deceleration/acceleration times	Check the actual current during the braking process using the scope image (E00); reduce the deceleration and acceleration values if necessary; the fault can only be acknowledged 30 s after the cause has been corrected
Clock frequency too high	Check the utilization of the drive, taking into account derating and the configured clock frequency (E20, B24); reduce the configured clock frequency or replace the drive controller if necessary; the fault can only be acknowledged 30 s after the cause has been corrected

Tab. 201: Event 38 – Causes and actions

19.1.5.10 Event 39: Overtemperature drive controller i2t

The i²t value of the drive controller (E22) has reached 100%. The maximum output current I_{2max} is limited to 100% of the nominal output current I_{2N,PU} (R04). If the i²t value increases to 105%, event 59: Overtemperature drive controller i2t is triggered.

The possible effects depend on the configured level (U02):

- 0: Inactive
- 1: Message
- 2: Warning
- 3: Fault

The drive controller has a **fault** if:

- A29 = 0: Inactive for Drive Based or PROFIdrive device control
or
- A540 = 0: Disable drive motor coasting for CiA 402 device controller

Response:

- The power unit is disabled and axis movement is no longer controlled by the drive controller
- The brakes engage

The drive controller has a **fault with a quick stop** if:

- A29 = 1: Active for Drive Based or PROFIdrive device control
or
- A540 = 2: Slow down on quick stop ramp for CiA 402 device controller

Response:

- The axis is stopped by a quick stop
- During the quick stop, the brakes remain released
- At the end of the quick stop, the power unit is disabled and axis movement is no longer controlled by the drive controller
- The brakes engage

Information

A rising edge for the release override signal (source: F06) is expected in the Switch on disabled, Ready to switch on, and Switched on states (E48) so that the brake is released.

Cause	Check and action
Wrong drive controller design	Check the design and change the drive controller type if necessary
Increased or reduced mechanical friction	Check the service status of the mechanical system of all axes and service them if necessary
Mechanical block	Check the output of all axes and remove the block if necessary
Short deceleration/acceleration times	Check the actual current during the braking process using the scope image (E00); reduce the deceleration and acceleration values if necessary
Clock frequency too high	Check the utilization of the drive, taking into account derating and the configured clock frequency (E20, B24); reduce the configured clock frequency or replace the drive controller if necessary

Tab. 202: Event 39 – Causes and actions

19.1.5.11 Event 40: Invalid data

The drive controller has a **fault**:

- The power unit is disabled and axis movement is no longer controlled by the drive controller
- The behavior of the brakes depends on the configuration of the safety module

Information

A rising edge for the release override signal (source: F06) is expected in the Switch on disabled, Ready to switch on, and Switched on states (E48) so that the brake is released.

Cause		Check and action
1: Fault, 2: Block missing, 3: Data security, 4: Checksum, 5: Read only, 6: Read error, 7: Block missing, 8: Wrong/illegal serial number	Invalid data in the internal memory of the drive controller	Determine the affected memory (Z730) and, based on that, replace the drive controller or motor; fault cannot be acknowledged
32: Electronic nameplate	No data available in the electronic nameplate	Deactivate the evaluation of the nameplate or replace the motor (B04); fault cannot be acknowledged
33: Electronic nameplate limit	Invalid data in the electronic nameplate	Deactivate the evaluation of the nameplate or replace the motor (B04); fault cannot be acknowledged
48: Reverse documentation	Defective memory in the SD card or internal memory of the drive controller	Replace the SD card or drive controller; fault cannot be acknowledged

Tab. 203: Event 40 – Causes and actions

19.1.5.12 Event 41: Temp.MotorTMP

The possible effects depend on the configured level (U15):

- 2: Warning
- 3: Fault

The drive controller has a **fault** if:

- A29 = 0: Inactive for Drive Based or PROFIdrive device control
or
- A540 = 0: Disable drive motor coasting for CiA 402 device controller

Response:

- The power unit is disabled and axis movement is no longer controlled by the drive controller
- The brakes engage

The drive controller has a **fault with a quick stop** if:

- A29 = 1: Active for Drive Based or PROFIdrive device control
or
- A540 = 2: Slow down on quick stop ramp for CiA 402 device controller

Response:

- The axis is stopped by a quick stop
- During the quick stop, the brakes remain released
- At the end of the quick stop, the power unit is disabled and axis movement is no longer controlled by the drive controller
- The brakes engage

Information

A rising edge for the release override signal (source: F06) is expected in the Switch on disabled, Ready to switch on, and Switched on states (E48) so that the brake is released.

Cause	Check and action
Motor temperature sensor connection error	Check the connection and correct it if necessary
Wrong sensor source for X2 – HIPERFACE DSL	Check the sensor settings and correct them if necessary (B35)
Wrong motor design	Check the design and change the motor type if necessary
Surrounding temperatures at the motor too high	Check the surrounding temperature and adjust it if necessary
Mechanical block of the motor	Check the output and remove the block if necessary
Increased or reduced mechanical friction	Check the service status of the mechanical system and service them if necessary

Tab. 204: Event 41 – Causes and actions

19.1.5.13 Event 42: TempBrakeRes

The drive controller has a **fault** if:

- A29 = 0: Inactive for Drive Based or PROFIdrive device control
or
- A540 = 0: Disable drive motor coasting for CiA 402 device controller

Response:

- The power unit is disabled and axis movement is no longer controlled by the drive controller
- The brakes engage

The drive controller has a **fault with a quick stop** if:

- A29 = 1: Active for Drive Based or PROFIdrive device control
or
- A540 = 2: Slow down on quick stop ramp for CiA 402 device controller

Response:

- The axis is stopped by a quick stop
- During the quick stop, the brakes remain released
- At the end of the quick stop, the power unit is disabled and axis movement is no longer controlled by the drive controller
- The brakes engage

Information

A rising edge for the release override signal (source: F06) is expected in the Switch on disabled, Ready to switch on, and Switched on states (E48) so that the brake is released.

Cause	Check and action
Short deceleration/acceleration times	Check the DC link voltage during the braking process using the scope image (E03); reduce the deceleration and acceleration values if necessary
Braking resistor too low	Check that the maximum permitted braking resistor power loss is suitable for the application and replace the braking resistor if necessary

Tab. 205: Event 42 – Causes and actions

19.1.5.14 Event 44: External fault 1

The drive controller has a **fault** if:

- A29 = 0: Inactive for Drive Based or PROFIdrive device control
or
- A540 = 0: Disable drive motor coasting for CiA 402 device controller

Response:

- The power unit is disabled and axis movement is no longer controlled by the drive controller
- The brakes engage

The drive controller has a **fault with a quick stop** if:

- A29 = 1: Active for Drive Based or PROFIdrive device control
or
- A540 = 2: Slow down on quick stop ramp for CiA 402 device controller

Response:

- The axis is stopped by a quick stop
- During the quick stop, the brakes remain released
- At the end of the quick stop, the power unit is disabled and axis movement is no longer controlled by the drive controller
- The brakes engage

Information

A rising edge for the release override signal (source: F06) is expected in the Switch on disabled, Ready to switch on, and Switched on states (E48) so that the brake is released.

Cause	Check and action
Application-specific	Application-specific

Tab. 206: Event 44 – Causes and actions

19.1.5.15 Event 45: Overtemp.motor i2t

The possible effects depend on the parameterized level (U10):

- 0: Inactive
- 1: Message
- 2: Warning
- 3: Fault

The drive controller has a **fault** if:

- A29 = 0: Inactive for Drive Based or PROFIdrive device control
or
- A540 = 0: Disable drive motor coasting for CiA 402 device controller

Response:

- The power unit is disabled and axis movement is no longer controlled by the drive controller
- The brakes engage

The drive controller has a **fault with a quick stop** if:

- A29 = 1: Active for Drive Based or PROFIdrive device control
or
- A540 = 2: Slow down on quick stop ramp for CiA 402 device controller

Response:

- The axis is stopped by a quick stop
- During the quick stop, the brakes remain released
- At the end of the quick stop, the power unit is disabled and axis movement is no longer controlled by the drive controller
- The brakes engage

Information

A rising edge for the release override signal (source: F06) is expected in the Switch on disabled, Ready to switch on, and Switched on states (E48) so that the brake is released.

Cause	Check and action
Wrong motor design	Check the design and change the motor type if necessary
Mechanical block of the motor	Check the output and remove the block if necessary
Increased or reduced mechanical friction	Check the service status of the mechanical system and service them if necessary

Tab. 207: Event 45 – Causes and actions

19.1.5.16 Event 46: Low voltage

The possible effects depend on the configured level (U00):

- 0: Inactive
- 1: Message
- 2: Warning
- 3: Fault

The drive controller has a **fault** if:

- A29 = 0: Inactive for Drive Based or PROFIdrive device control
or
- A540 = 0: Disable drive motor coasting for CiA 402 device controller

Response:

- The power unit is disabled and axis movement is no longer controlled by the drive controller
- The brakes engage

The drive controller has a **fault with a quick stop** if:

- A29 = 1: Active for Drive Based or PROFIdrive device control
or
- A540 = 2: Slow down on quick stop ramp for CiA 402 device controller

Response:

- The axis is stopped by a quick stop
- During the quick stop, the brakes remain released
- At the end of the quick stop, the power unit is disabled and axis movement is no longer controlled by the drive controller
- The brakes engage

Information

A rising edge for the release override signal (source: F06) is expected in the Switch on disabled, Ready to switch on, and Switched on states (E48) so that the brake is released.

Cause	Check and action
Supply voltage does not correspond to the configured supply voltage	Check the supply voltage, parameterized supply voltage and undervoltage limit and correct them if necessary (A36, A35)
Supply voltage below undervoltage limit	Check undervoltage limit and correct it if necessary (A35)

Tab. 208: Event 46 – Causes and actions

19.1.5.17 Event 47: Torque/force-max. limit

The possible effects depend on the configured level (U20):

- 0: Inactive
- 1: Message
- 2: Warning
- 3: Fault

The drive controller has a **fault** if:

- A29 = 0: Inactive for Drive Based or PROFIdrive device control
or
- A540 = 0: Disable drive motor coasting for CiA 402 device controller

Response:

- The power unit is disabled and axis movement is no longer controlled by the drive controller
- The brakes engage

The drive controller has a **fault with a quick stop** if:

- A29 = 1: Active for Drive Based or PROFIdrive device control
or
- A540 = 2: Slow down on quick stop ramp for CiA 402 device controller

Response:

- The axis is stopped by a quick stop
- During the quick stop, the brakes remain released
- At the end of the quick stop, the power unit is disabled and axis movement is no longer controlled by the drive controller
- The brakes engage

Information

A rising edge for the release override signal (source: F06) is expected in the Switch on disabled, Ready to switch on, and Switched on states (E48) so that the brake is released.

Cause	Check and action
Incorrectly selected torque/force limits	Check the general machine limit and adjust it if necessary (C03, C05); check the application limits and the parameters dependent on the operating mode and adjust them if necessary (Drive Based C132, C133 or CiA 402 A559)
Wrong motor design	Check the design and change the motor type if necessary
Mechanical block	Check the output and remove the block if necessary
Brake closed	Check the connection, supply voltage and parameterization and correct them if necessary (F00)
Connection error at the motor	Check the connection and correct it if necessary
Connection error at the encoder	Check the connection and correct it if necessary
Wrong encoder measurement direction	Compare the attachment and measurement direction of the encoder with the corresponding values of the H parameters and correct them if necessary

Tab. 209: Event 47 – Causes and actions

19.1.5.18 Event 48: Brake release monitoring

The possible effects depend on the configured level (U26).

The drive controller has a **fault** if:

- A29 = 0: Inactive for Drive Based or PROFIdrive device control
or
- A540 = 0: Disable drive motor coasting for CiA 402 device controller

Response:

- The power unit is disabled and axis movement is no longer controlled by the drive controller
- The brakes engage

The drive controller has a **fault with a quick stop** if:

- A29 = 1: Active for Drive Based or PROFIdrive device control
or
- A540 = 2: Slow down on quick stop ramp for CiA 402 device controller

Response:

- The axis is stopped by a quick stop
- During the quick stop, the brakes remain released
- At the end of the quick stop, the power unit is disabled and axis movement is no longer controlled by the drive controller
- The brakes engage

Information

A rising edge for the release override signal (source: F06) is expected in the Switch on disabled, Ready to switch on, and Switched on states (E48) so that the brake is released.

Cause	Check and action
Connection error	Check the connection and correct it if necessary
Release monitoring not adjusted	Adjust release monitoring

Tab. 210: Event 48 – Causes and actions

19.1.5.19 Event 49: Brake

The drive controller has a **fault** if:

- A29 = 0: Inactive for Drive Based or PROFIdrive device control
or
- A540 = 0: Disable drive motor coasting for CiA 402 device controller

Response:

- The power unit is disabled and axis movement is no longer controlled by the drive controller
- The brakes engage

The drive controller has a **fault with a quick stop** if:

- A29 = 1: Active for Drive Based or PROFIdrive device control
or
- A540 = 2: Slow down on quick stop ramp for CiA 402 device controller

Response:

- The axis is stopped by a quick stop
- During the quick stop, the brakes remain released
- At the end of the quick stop, the power unit is disabled and axis movement is no longer controlled by the drive controller
- The brakes engage

Information

A rising edge for the release override signal (source: F06) is expected in the Switch on disabled, Ready to switch on, and Switched on states (E48) so that the brake is released.

Cause	Check and action	
10: Brake monitoring with engaged brake, 11: Brake monitoring with released brake, 12: Brake monitoring during engaging time, 13: Brake monitoring during release time	Connection error	Check the connection and correct it if necessary
	Defective power cable	Check the cable and replace it if necessary
	Indirect brake connection	Check the connection and configured brake connection and correct them if necessary (F105)

Tab. 211: Event 49 – Causes and actions

19.1.5.20 Event 50: Safety module

The drive controller has a **fault**:

- The power unit is disabled and axis movement is no longer controlled by the drive controller
- The behavior of the brakes depends on the configuration of the safety module

Information

A rising edge for the release override signal (source: F06) is expected in the Switch on disabled, Ready to switch on, and Switched on states (E48) so that the brake is released.

Cause		Check and action
1: Inconsistent request (single channel)	Connection error	Check the connection and correct it if necessary; error cannot be acknowledged until both STO channels have been requested for at least 100 ms
2: Wrong safety module	The projected E53 safety module does not match the E54[0] detected by the system	Check the project configuration and drive controller and correct the project configuration or exchange the drive controller if necessary; fault cannot be acknowledged
3: Internal error	Defective safety module	Exchange drive controller; fault cannot be acknowledged
4: PowerUp sequence error	Defective safety module	Exchange drive controller; fault cannot be acknowledged
6: Fatal error	Safety module is in an error state	Determine offset and index from the active error code (see S02, S03) and take the appropriate measures [▶ 311] ; fault cannot be acknowledged
8: Safety module startup error	Faulty synchronization between drive controller and safety module when starting the device	Check the drive controller firmware and, if necessary, update to version 6.3-E or higher, then restart the drive controller; fault cannot be acknowledged
10: Safety config. missing in ParaModul	No safety configuration available on the SD card/in the Paramodul	Save safety configuration (A00)
11: Safety config. from ParaModul activated	New safety configuration activated from the SD card/Paramodul	–
12: Safety config. missing in Paramodul&safety module	No valid safety configuration available in safety module and SD card/Paramodul	Create a safety configuration in PASmotion Safety Configurator, use DriveControlSuite to transfer it to the drive controller and save it there (A00); fault cannot be acknowledged
13: Safety module activation error	Faulty activation of the safety configuration	Restart the drive controller and activate the safety configuration or start the drive controller without the SD card/Paramodul, then create a new safety configuration in PASmotion Safety Configurator, use DriveControlSuite to transfer it to the drive controller and save it there (A00); fault cannot be acknowledged
15: Safety module error	Safety module is in an error state	Determine offset and index from the active error code (PASmotion Safety Configurator Error stack or S02, S03) and take the appropriate measures [▶ 311]

Cause		Check and action
17: Error class LIMIT	Limit value of a safety function exceeded	Determine offset and index from the active error code (PASmotion Safety Configurator Error stack or S02, S03) and take the appropriate measures [▶ 311]
18: Error class OTHER	Safety module is in the warning or message state	Determine offset and index from the active error code (PASmotion Safety Configurator Error stack or S02, S03) and take the appropriate measures [▶ 311]
19: Safety module invalid FSoE address	Invalid FSoE address	Check the FSoE address of the SubInstance (valid value range: 1-254)

Tab. 212: Event 50 – Causes and actions

19.1.5.21 Event 51: Virtual master software limit switch

The possible effects depend on the configured level (U24).

- 0: Inactive
- 1: Message
- 3: Fault

The drive controller has a **fault** if:

- A29 = 0: Inactive for Drive Based or PROFIdrive device control
or
- A540 = 0: Disable drive motor coasting for CiA 402 device controller

Response:

- The power unit is disabled and axis movement is no longer controlled by the drive controller
- The brakes engage

The drive controller has a **fault with a quick stop** if:

- A29 = 1: Active for Drive Based or PROFIdrive device control
or
- A540 = 2: Slow down on quick stop ramp for CiA 402 device controller

Response:

- The axis is stopped by a quick stop
- During the quick stop, the brakes remain released
- At the end of the quick stop, the power unit is disabled and axis movement is no longer controlled by the drive controller
- The brakes engage

Information

A rising edge for the release override signal (source: F06) is expected in the Switch on disabled, Ready to switch on, and Switched on states (E48) so that the brake is released.

Event 51: Virtual master software limit switch only affects the device control of the axis. A quick stop of the virtual master can also be triggered with G57.

Cause		Check and action
1: SW-limit switch positive, 2: SW-limit switch negative	End of the travel range reached	Move in the travel range in the direction opposite the limit switch
	Travel range too small	Check the positions of the software limit switch and correct them if necessary (G146, G147)
3: +/- 31 bit computing limit reached	Computing limit of the data type reached	Check the command sequences for multiple successive 3: MC_MoveAdditive commands without a breakpoint and the number of decimal places of the axis model and reduce them if necessary (G46)

Tab. 213: Event 51 – Causes and actions

19.1.5.22 Event 52: Communication

The drive controller has a **fault** if:

- A29 = 0: Inactive for Drive Based or PROFIdrive device control
or
- A540 = 0: Disable drive motor coasting for CiA 402 device controller

Response:

- The power unit is disabled and axis movement is no longer controlled by the drive controller
- The brakes engage

The drive controller has a **fault with a quick stop** if:

- A29 = 1: Active for Drive Based or PROFIdrive device control
or
- A540 = 2: Slow down on quick stop ramp for CiA 402 device controller

Response:

- The axis is stopped by a quick stop
- During the quick stop, the brakes remain released
- At the end of the quick stop, the power unit is disabled and axis movement is no longer controlled by the drive controller
- The brakes engage

Information
A rising edge for the release override signal (source: F06) is expected in the Switch on disabled, Ready to switch on, and Switched on states (E48) so that the brake is released.

Cause	Check and action
4: PZD-Timeout	Missing process data Check the cycle time in the controller and tolerated failure time for monitoring the PZD communication in the drive controller and correct if necessary (A109)
6: EtherCAT PDO-Timeout	Missing process data Check the task cycle time in the EtherCAT MainDevice and the timeout time in the drive controller and correct them if necessary (A258)
7: Reserved	Synchronization error Check the synchronization settings in the EtherCAT MainDevice and correct them if necessary
	Connection error Check the connection and shielding and correct them if necessary
14: PZD parameter figure faulty	Missing mapping Check the mapping for unmappable parameters and correct them if necessary
15: Wrong firmware for applicataion	Projected fieldbus identification and that of the drive controller do not match Check the projected fieldbus identification and the fieldbus identification of the drive controller and change the fieldbus if necessary (E59[2], E52[3])
16: PROFINET Sign-of-Life synchronisation failed	Synchronization error Obey the information in the TIA Portal and update the GSD file if necessary; check the controller or technology object for clock synchronicity and correct if necessary

Tab. 214: Event 52 – Causes and actions

19.1.5.23 Event 53: Limit switch

The drive controller has a **fault** if:

- A29 = 0: Inactive for Drive Based or PROFIdrive device control
or
- A540 = 0: Disable drive motor coasting for CiA 402 device controller

Response:

- The power unit is disabled and axis movement is no longer controlled by the drive controller
- The brakes engage

The drive controller has a **fault with a quick stop** if:

- A29 = 1: Active for Drive Based or PROFIdrive device control
or
- A540 = 2: Slow down on quick stop ramp for CiA 402 device controller

Response:

- The axis is stopped by a quick stop
- During the quick stop, the brakes remain released
- At the end of the quick stop, the power unit is disabled and axis movement is no longer controlled by the drive controller
- The brakes engage

Information

A rising edge for the release override signal (source: F06) is expected in the Switch on disabled, Ready to switch on, and Switched on states (E48) so that the brake is released.

Cause		Check and action
1: Hardware-Limit-Switch positive, 2: Hardware-Limit-Switch negative	End of the travel range reached	Move in the travel range in the direction opposite the limit switch
	Connection error	Check the connection and source parameters and correct them if necessary (I101, I102)
	Defective cable	Check the cable and replace it if necessary
3: SW-limit switch positive, 4: SW-limit switch negative	End of the travel range reached	Move in the travel range in the direction opposite the limit switch
	Travel range too small	Check the positions of the software limit switches and correct them if necessary (Drive Based I50, I51 or CiA A570[0], A570[1])
5: +/- 31 bit computing limit reached	Computing limit of the data type reached	Check the command sequences for multiple successive 3: MC_MoveAdditive commands without a breakpoint and the number of decimal places of the axis model and reduce them if necessary (I06)
6: Linear motor moving range	Axis is 200 m away from the commutation reference point	Check the axis model and correct it if necessary
7: Both limit switches not connected	Connection error	Check the connection and source parameters and correct them if necessary (I101, I102)
	Defective cable	Check the cable and replace it if necessary

Tab. 215: Event 53 – Causes and actions

19.1.5.24 Event 54: Following error

The possible effects depend on the configured level (U22).

- 0: Inactive
- 1: Message
- 2: Warning
- 3: Fault

The drive controller has a **fault** if:

- A29 = 0: Inactive for Drive Based or PROFIdrive device control
or
- A540 = 0: Disable drive motor coasting for CiA 402 device controller

Response:

- The power unit is disabled and axis movement is no longer controlled by the drive controller
- The brakes engage

The drive controller has a **fault with a quick stop** if:

- A29 = 1: Active for Drive Based or PROFIdrive device control
or
- A540 = 2: Slow down on quick stop ramp for CiA 402 device controller

Response:

- The axis is stopped by a quick stop
- During the quick stop, the brakes remain released
- At the end of the quick stop, the power unit is disabled and axis movement is no longer controlled by the drive controller
- The brakes engage

Information

A rising edge for the release override signal (source: F06) is expected in the Switch on disabled, Ready to switch on, and Switched on states (E48) so that the brake is released.

Cause	Check and action
Incorrectly selected torque/force limits	Check the general machine limit and adjust it if necessary (C03, C05); check the application limits and adjust them if necessary (Drive Based/PROFIdrive: C132, C133 and the parameters dependent on the operating mode; CiA 402: A559)
Maximum permitted lag is too small	Check the maximum permitted following error and correct it if necessary (Drive Based/PROFIdrive: I21; CiA 402: A546)
Mechanical block	Check the output and remove the block if necessary
Brake closed	Check the connection, supply voltage and parameterization and correct them if necessary (F00)

Tab. 216: Event 54 – Causes and actions

19.1.5.25 Event 56: Overspeed

The drive controller has a **fault** if:

- U30 = 0: Inactive

Response:

- The power unit is disabled and axis movement is no longer controlled by the drive controller
- The brakes engage

The drive controller has a **fault with emergency braking** if:

- U30 = 1: Active and
- A29 = 1: Active for Drive Based or PROFIdrive device control
or
- U30 = 1: Active and
- A540 = 2: Slow down on quick stop ramp for CiA 402 device controller

Response:

- The axis is stopped by emergency braking
- The brakes engage
- At the end of emergency braking, the power unit is disabled and axis movement is no longer controlled by the drive controller

Information

Emergency braking is only possible for the synchronous servo, Lean, torque, and synchronous linear motor types.

Information

A rising edge for the release override signal (source: F06) is expected in the Switch on disabled, Ready to switch on, and Switched on states (E48) so that the brake is released.

Information

The event is only triggered if the checking rules for Enable-on are violated.

Cause		Check and action
1: Motor encoder, 2: Position encoder, 3: Motor & position encoder	Maximum permitted velocity too small	Check the maximum permitted velocity and increase it if necessary (I10); event is triggered if actual velocity > I10 × 1.111
	Overshooting control system	Check the actual velocity using the scope image (Sensing time: 250 μs, actual motor velocity: E15, E91; actual position velocity I88) and, if necessary, reduce the gain of the control system (I20, C31)
1: Motor encoder, 3: Motor & position encoder	Wrong commutation offset	Check the commutation offset using the Test phase action (B40)
	Faulty motor encoder	Check the velocity display of the encoder at a standstill (E15, E91) and replace the encoder if necessary
2: Position encoder, 3: Motor & position encoder	Faulty position encoder	Check the velocity display of the encoder at a standstill (I88) and replace the encoder if necessary

Tab. 217: Event 56 – Causes and actions

19.1.5.26 Event 57: Runtime requirement

The drive controller has a **fault** if:

- A29 = 0: Inactive for Drive Based or PROFIdrive device control
or
- A540 = 0: Disable drive motor coasting for CiA 402 device controller

Response:

- The power unit is disabled and axis movement is no longer controlled by the drive controller
- The brakes engage

The drive controller has a **fault with a quick stop** if:

- A29 = 1: Active for Drive Based or PROFIdrive device control
or
- A540 = 2: Slow down on quick stop ramp for CiA 402 device controller

Response:

- The axis is stopped by a quick stop
- During the quick stop, the brakes remain released
- At the end of the quick stop, the power unit is disabled and axis movement is no longer controlled by the drive controller
- The brakes engage

Information

A rising edge for the release override signal (source: F06) is expected in the Switch on disabled, Ready to switch on, and Switched on states (E48) so that the brake is released.

Cause	Check and action
3: RT3, 4: RT4, 5: RT5	Exceeding the cycle time Check the utilization (E191) and increase the cycle time if necessary (A150)

Tab. 218: Event 57 – Causes and actions

19.1.5.27 Event 59: Overtemperature drive controller i2t

The i²t value of the drive controller (E22) has reached 105%.

The drive controller has a **fault** if:

- A29 = 0: Inactive for Drive Based or PROFIdrive device control
or
- A540 = 0: Disable drive motor coasting for CiA 402 device controller

Response:

- The power unit is disabled and axis movement is no longer controlled by the drive controller
- The brakes engage

The drive controller has a **fault with a quick stop** if:

- A29 = 1: Active for Drive Based or PROFIdrive device control
or
- A540 = 2: Slow down on quick stop ramp for CiA 402 device controller

Response:

- The axis is stopped by a quick stop
- During the quick stop, the brakes remain released
- At the end of the quick stop, the power unit is disabled and axis movement is no longer controlled by the drive controller
- The brakes engage

Information

A rising edge for the release override signal (source: F06) is expected in the Switch on disabled, Ready to switch on, and Switched on states (E48) so that the brake is released.

Cause	Check and action
Wrong drive controller design	Check the design and change the drive controller type if necessary; the fault can only be acknowledged 30 s after the cause has been corrected
Increased or reduced mechanical friction	Check the service status of the mechanical system and service them if necessary; the fault can only be acknowledged 30 s after the cause has been corrected
Short deceleration/acceleration times	Check the actual current during the braking process using the scope image (E00); reduce the deceleration and acceleration values if necessary; the fault can only be acknowledged 30 s after the cause has been corrected
Clock frequency too high	Check the utilization of the drive, taking into account derating and the configured clock frequency (E20, B24); reduce the configured clock frequency or replace the drive controller if necessary; the fault can only be acknowledged 30 s after the cause has been corrected

Tab. 219: Event 59 – Causes and actions

19.1.5.28 Event 60: Application event 0 – Event 67: Application event 7

The possible effects depend on the configured level (U100, U110, U120, U130, U140, U150, U160, U170):

- 0: Inactive
- 1: Message
- 2: Warning
- 3: Fault

The drive controller has a **fault** if:

- A29 = 0: Inactive for Drive Based or PROFIdrive device control
or
- A540 = 0: Disable drive motor coasting for CiA 402 device controller

Response:

- The power unit is disabled and axis movement is no longer controlled by the drive controller
- The brakes engage

The drive controller has a **fault with a quick stop** if:

- A29 = 1: Active for Drive Based or PROFIdrive device control
or
- A540 = 2: Slow down on quick stop ramp for CiA 402 device controller

Response:

- The axis is stopped by a quick stop
- During the quick stop, the brakes remain released
- At the end of the quick stop, the power unit is disabled and axis movement is no longer controlled by the drive controller
- The brakes engage

Information

A rising edge for the release override signal (source: F06) is expected in the Switch on disabled, Ready to switch on, and Switched on states (E48) so that the brake is released.

Cause	Check and action
Application-specific	Application-specific

Tab. 220: Events 60 – 67 – Causes and actions

19.1.5.29 Event 68: External fault 2

The drive controller has a **fault** if:

- A29 = 0: Inactive for Drive Based or PROFIdrive device control
or
- A540 = 0: Disable drive motor coasting for CiA 402 device controller

Response:

- The power unit is disabled and axis movement is no longer controlled by the drive controller
- The brakes engage

The drive controller has a **fault with a quick stop** if:

- A29 = 1: Active for Drive Based or PROFIdrive device control
or
- A540 = 2: Slow down on quick stop ramp for CiA 402 device controller

Response:

- The axis is stopped by a quick stop
- During the quick stop, the brakes remain released
- At the end of the quick stop, the power unit is disabled and axis movement is no longer controlled by the drive controller
- The brakes engage

Information

A rising edge for the release override signal (source: F06) is expected in the Switch on disabled, Ready to switch on, and Switched on states (E48) so that the brake is released.

Cause	Check and action
Application-specific	Application-specific

Tab. 221: Event 68 – Causes and actions

19.1.5.30 Event 69: Motor connection

The possible effects depend on the configured level (U12).

- 0: Inactive
- 3: Fault

The drive controller has a **fault** if:

- A29 = 0: Inactive for Drive Based or PROFIdrive device control
or
- A540 = 0: Disable drive motor coasting for CiA 402 device controller

Response:

- The power unit is disabled and axis movement is no longer controlled by the drive controller
- The brakes engage

The drive controller has a **fault with a quick stop** if:

- A29 = 1: Active for Drive Based or PROFIdrive device control
or
- A540 = 2: Slow down on quick stop ramp for CiA 402 device controller

Response:

- The axis is stopped by a quick stop
- During the quick stop, the brakes remain released
- At the end of the quick stop, the power unit is disabled and axis movement is no longer controlled by the drive controller
- The brakes engage

Information

A rising edge for the release override signal (source: F06) is expected in the Switch on disabled, Ready to switch on, and Switched on states (E48) so that the brake is released.

Cause		Check and action
2: No motor connected	Connection error	Check the connection and correct it if necessary
	Defective power cable	Check the cable and replace it if necessary
	Nominal speed too high (asynchronous motor)	Check the speed of the motor and reduce the value if necessary (B13)
3: Wake and Shake failed (Commutation finding with Wake and Shake failed)	Increased or reduced mechanical friction	Check the service status of the mechanical system and service them if necessary
	Mechanical block	Check the output and remove the block if necessary
	Axis with large mass inertia	Increase minimum wait time between Wake and Shakes (B33)
4: Brake (Commutation finding with Wake and Shake failed)	Brake engaged	Check control of the brakes and carry out action B50 if necessary, see Commutation finding [▶ 364]

Tab. 222: Event 69 – Causes and actions

19.1.5.31 Event 70: Parameter consistency

The drive controller has a **fault**:

- The power unit is disabled and axis movement is no longer controlled by the drive controller
- The behavior of the brakes depends on the configuration of the safety module

Information

A rising edge for the release override signal (source: F06) is expected in the Switch on disabled, Ready to switch on, and Switched on states (E48) so that the brake is released.

Information

The event is only triggered if the checking rules for Enable-on are violated.

Cause		Check and action
1: Wrong encoder model	Encoder model unsuitable for control type	Check the control mode, motor encoder and encoder and correct them if necessary (B20, B26, H parameters)
3: B12<->B20	Nominal current of the motor exceeds the drive controller nominal current (4 kHz)	Check the motor nominal current against 150% of the drive controller nominal current at a clock frequency of 4 kHz and, if necessary, reduce the motor nominal current or change the drive controller type (B12, R04[0])
4: B10<->H31	Unsupported combination of resolver/motor number of poles	Check number of poles of the resolver and number of poles of the motor and correct them if necessary (H08, H148, B10)
5: Negative slip frequency	Negative slip	Check the nominal velocity, nominal frequency and number of poles of the motor and, if necessary, correct them (B13, B15, B10)
8: v-max (I10) exceeds maximum (B83)	Maximum permitted velocity exceeds the maximum motor velocity	Check the maximum permitted velocity and the maximum motor velocity and correct them if necessary (I10, B83)
	B83 parameterized too large	For Lean motors, reduce B83 to max. 6000 rpm
11: Reference retaining	Conditions for reference without tracking not met	Check that the reference is retained and that the measurement range covers the travel range and make corrections if necessary (I46, limited travel range I00: Software limit switch must be parameterized; infinite travel range I00: Measurement range must correspond to the revolution length Drive Based/PROFIdrive I01 or CiA 402 A568[1] or an entire multiple)
12: Type of axis	Rotational axis model not suitable for synchronous linear motor	Correct the axis type of the axis model (I00)
13: Motor temperature sensor	Unsupported temperature sensors	Check the motor temperature sensor type in the motor and the drive controller series and, if necessary, change the motor or drive controller series

Cause		Check and action
14: Max. acceleration I11>B143	Maximum permitted velocity is above maximum motor acceleration	Check the maximum permissible velocity and maximum motor acceleration and correct them if necessary (Drive Based/PROFIdrive: I11; CiA 402: minimum values of A604 and A605, B143)
SY6 option: 15: Safety watchdog time	Monitoring of PDO timeout deactivated	Check the EtherCAT PDO timeout in the drive controller and activate it if necessary (A258 = 0 or 65535)
	SyncManager watchdog = 0	Check the EtherCAT SyncManager watchdog in the EtherCAT MainDevice and increase it if necessary (A258 = 65534, A259[0])
	Ratio of FSoE watchdog time to EtherCAT PDO timeout too small	Check the FSoE watchdog time in the FSoE MainInstance and EtherCAT PDO timeout in the drive controller; if necessary, increase the watchdog time or reduce the timeout (condition: FSoE watchdog time > EtherCAT PDO timeout + FSoE cycle time + 26 ms; S27, A258, S26)
	Ratio of FSoE watchdog time to EtherCAT SyncManager watchdog too small	Check the FSoE watchdog time in the FSoE MainInstance and EtherCAT SyncManager watchdog in the EtherCAT MainDevice; if necessary, increase the watchdog time or reduce the SyncManager watchdog (condition: FSoE watchdog time > EtherCAT SyncManager watchdog + FSoE cycle time + 26 ms; S27, A258 = 65534, A259[0], S26)
SU6 option: 15: Safety watchdog time	Monitoring of PZD timeout deactivated	Check the PZD timeout in the drive controller and activate it if necessary (A109 = 0 or 65535)
	Ratio of PROFIsafe watchdog time to PZD timeout too small	Check the PROFIsafe watchdog time in TIA Portal and PZD timeout in the drive controller; if necessary, increase the watchdog time or reduce the PZD timeout (condition: PROFIsafe watchdog time > PZD timeout + PROFIsafe data bus runtime + 26 ms; S46 > A109 + S44 + 26 ms)
16: I10 > C11	Maximum permitted velocity is above maximum gear unit input speed	Check the maximum permitted velocity and the maximum gear unit input speed and correct them if necessary (I10, C11)

Tab. 223: Event 70 – Causes and actions

19.1.5.32 Event 71: Firmware

Cause 1:

The drive controller has a **fault**:

- The power unit is disabled and axis movement is no longer controlled by the drive controller
- The behavior of the brakes depends on the configuration of the safety module

Information

A rising edge for the release override signal (source: F06) is expected in the Switch on disabled, Ready to switch on, and Switched on states (E48) so that the brake is released.

Cause 3:

The drive controller has a **fault** if:

- A29 = 0: Inactive for Drive Based or PROFIdrive device control
or
- A540 = 0: Disable drive motor coasting for CiA 402 device controller

Response:

- The power unit is disabled and axis movement is no longer controlled by the drive controller
- The brakes engage

The drive controller has a **fault with a quick stop** if:

- A29 = 1: Active for Drive Based or PROFIdrive device control
or
- A540 = 2: Slow down on quick stop ramp for CiA 402 device controller

Response:

- The axis is stopped by a quick stop
- During the quick stop, the brakes remain released
- At the end of the quick stop, the power unit is disabled and axis movement is no longer controlled by the drive controller
- The brakes engage

Information

A rising edge for the release override signal (source: F06) is expected in the Switch on disabled, Ready to switch on, and Switched on states (E48) so that the brake is released.

Cause		Check and action
1: Firmware defective	Defective firmware	Update the firmware; fault cannot be acknowledged
	Defective drive controller	Exchange drive controller; fault cannot be acknowledged
3: CRC-error	Defective firmware	Update the firmware; fault cannot be acknowledged
	Defective drive controller	Check for repeated triggering of the event after a restart; if necessary, replace the drive controller

Tab. 224: Event 71 – Causes and actions

19.1.5.33 Event 76: Position encoder

The drive controller has a **fault** if:

- U30 = 0: Inactive and
- A29 = 0: Inactive for Drive Based or PROFIdrive device control
or
- U30 = 1: Active and
- A540 = 0: Disable drive motor coasting for CiA 402 device controller

Response:

- The power unit is disabled and axis movement is no longer controlled by the drive controller
- The brakes engage

The drive controller has a **fault with a quick stop** if:

- A29 = 0: Inactive for Drive Based or PROFIdrive device control
or
- A540 = 2: Slow down on quick stop ramp for CiA 402 device controller

Response:

- The axis is stopped by a quick stop
- During the quick stop, the brakes remain released
- At the end of the quick stop, the power unit is disabled and axis movement is no longer controlled by the drive controller
- The brakes engage

The drive controller has a **fault with emergency braking** if:

- U30 = 1: Active and
- A29 = 1: Active for Drive Based or PROFIdrive device control
or
- U30 = 1: Active and
- A540 = 2: Slow down on quick stop ramp for CiA 402 device controller

Response:

- The axis is stopped by emergency braking
- The brakes engage
- At the end of emergency braking, the power unit is disabled and axis movement is no longer controlled by the drive controller

Information	
--------------------	--

Emergency braking is only possible for the synchronous servo, Lean, torque, and synchronous linear motor types.

Information	
--------------------	--

A rising edge for the release override signal (source: F06) is expected in the Switch on disabled, Ready to switch on, and Switched on states (E48) so that the brake is released.

The reference is deleted (I86).

Cause		Check and action
1: Parameter <-> encoder	Inconsistent parameterization	Compare the specification of the connected encoder to the corresponding values of the H parameters and correct them if necessary
2: Maximum speed	Exceeded encoder maximum velocity	Check the actual velocity during a movement using the scope image (I88) and adjust the permitted encoder maximum velocity if necessary (I297)
	Connection error	Check the connection and shielding and correct them if necessary
	Mass inertia ratio of load to Lean motor	Check the setting of the mass inertia ratio (C30) and reduce it if necessary
	Dynamic control of the Lean motor	Check the control settings; if necessary, reduce the gain (C31, I20) and increase the reset times (C32)
	Dynamic set values for the Lean motor	Check the dynamics of the application set values and reduce them if necessary
	Dynamic acceleration of the Lean motor	Use a scope image to check the actual velocity and shifting speed during a movement (E15, E959) and reduce the shifting filter time constant if necessary (B137)
6: X4 EnDat encoder found	Inconsistent parameterization	Compare the connected encoder to the parameterized encoder and correct it if necessary (H00)
7: X4 A track/Incremental	Connection error	Check the connection and correct it if necessary
8: X4 no encoder found	Connection error	Check the connection and correct it if necessary
	Defective encoder cable	Check the cable and replace it if necessary
	Faulty supply voltage	Check the supply voltage of the encoder and correct if necessary
	Inconsistent parameterization	Compare the connected encoder to the parameterized encoder and correct it if necessary (H00)
9: Referencing failed	Reference set for inactive Lean motor position determination	Check device status (E48) and, if necessary, activate the enable signal
10: X4 A track/Clk, 11: X4 B track/Dat	Defective encoder cable	Check the cable and replace it if necessary
13: X4-EnDat alarm	Defective EnDat encoder	Replace the motor; EnDat 2.1 digital, EnDat 2.2 digital, EnDat 3: Fault cannot be acknowledged
14: X4 EnDat CRC, 15: X4 double transmission	Connection error	Check the connection and correct it if necessary
	Electromagnetic interference	Take EMC recommendations into account [► 104] and, if necessary, increase the fault tolerance (I298)
16: X4 busy	Synchronization error	Update firmware
17: EBI encoder low battery	Battery in battery module weak	Replace the battery; reference is not deleted by the event

Cause		Check and action
18: EBI encoder battery empty	Battery in battery module empty	Replace the battery
	Initial connection	–
	Connection error	Check the connection and correct it if necessary
	Defective encoder cable	Check the cable and replace it if necessary
	Faulty battery module	Check the battery module and replace it if necessary
19: Alarm bit	Encoder fault	Check the specification of the encoder regarding the alarm bit
20: Resolver carrier, 21: Resolver sin/cos undervoltage, 22: Resolver sin/cos overvoltage	Defective encoder cable	Check the cable and replace it if necessary
	Incompatible encoder	Compare the specification of the encoder with the corresponding specifications from STOBER and replace the encoder or motor if necessary; fault cannot be acknowledged
21: Resolver sin/cos undervoltage	Incompatible encoder; phase search or calibration of the optimal resolver excitation failed	Compare the specification of the encoder with the corresponding specifications from STOBER; if necessary, calibrate the starting point for calibrating the optimal resolver excitation and the phase search (B40); fault cannot be acknowledged
24: Resolver failure	Defective encoder cable	Check the cable and replace it if necessary
48: X4 zero pulse missing	Defective encoder cable	Check the cable and replace it if necessary
	Connection error	Check the connection and correct it if necessary
	Late zero track	Check number of encoder increments per rotation and correct it if necessary (H02)
49: X4 zero pulse distance too small	Defective encoder cable	Check the cable and replace it if necessary
	Connection error	Check the connection and correct it if necessary
	Early zero track	Check number of encoder increments per rotation and correct it if necessary (H02)
60: Hiperface synchronisation, 61: Hiperface timeout, 62: Hiperface signal quality, 63: Hiperface link	Defective encoder cable	Check the cable and replace it if necessary
	Connection error	Check the connection and correct it if necessary
	Electromagnetic interference	Take EMC recommendations into account [► 104] and, if necessary, increase the fault tolerance (I298)
64: EnDat3 Timeout, 65: EnDat3 invalid Request, 66: EnDat3 Position Check	Defective encoder cable	Check the cable and replace it if necessary
	Connection error	Check the connection and correct it if necessary
	Electromagnetic interference	Take EMC recommendations into account [► 104] and, if necessary, increase the fault tolerance (I298)

Tab. 225: Event 76 – Causes and actions

19.1.5.34 Event 77: Master encoder

The drive controller has a **fault** if:

- A29 = 0: Inactive for Drive Based or PROFIdrive device control
or
- A540 = 0: Disable drive motor coasting for CiA 402 device controller

Response:

- The power unit is disabled and axis movement is no longer controlled by the drive controller
- The brakes engage

The drive controller has a **fault with a quick stop** if:

- A29 = 1: Active for Drive Based or PROFIdrive device control
or
- A540 = 2: Slow down on quick stop ramp for CiA 402 device controller

Response:

- The axis is stopped by a quick stop
- During the quick stop, the brakes remain released
- At the end of the quick stop, the power unit is disabled and axis movement is no longer controlled by the drive controller
- The brakes engage

Information

A rising edge for the release override signal (source: F06) is expected in the Switch on disabled, Ready to switch on, and Switched on states (E48) so that the brake is released.

The reference is deleted (G89).

Cause	Check and action								
1: Parameter <-> encoder	<table border="1" style="width: 100%; border-collapse: collapse;"> <tr> <td style="padding: 5px;">Inconsistent parameterization</td> <td style="padding: 5px;">Compare the specification of the connected encoder to the corresponding values of the H parameters and correct them if necessary</td> </tr> </table>	Inconsistent parameterization	Compare the specification of the connected encoder to the corresponding values of the H parameters and correct them if necessary						
Inconsistent parameterization	Compare the specification of the connected encoder to the corresponding values of the H parameters and correct them if necessary								
2: Maximum speed	<table border="1" style="width: 100%; border-collapse: collapse;"> <tr> <td style="padding: 5px;">Exceeded encoder maximum velocity</td> <td style="padding: 5px;">Check the actual velocity during a movement using the scope image (G105) and adjust the permitted encoder maximum velocity if necessary (G297)</td> </tr> <tr> <td style="padding: 5px;">Connection error</td> <td style="padding: 5px;">Check the connection and shielding and correct them if necessary</td> </tr> </table>	Exceeded encoder maximum velocity	Check the actual velocity during a movement using the scope image (G105) and adjust the permitted encoder maximum velocity if necessary (G297)	Connection error	Check the connection and shielding and correct them if necessary				
Exceeded encoder maximum velocity	Check the actual velocity during a movement using the scope image (G105) and adjust the permitted encoder maximum velocity if necessary (G297)								
Connection error	Check the connection and shielding and correct them if necessary								
6: X4 EnDat encoder found	Inconsistent parameterization Compare the connected encoder to the parameterized encoder and correct it if necessary (H00)								
7: X4 A track/Incremental	Connection error Check the connection and correct it if necessary								
8: X4 no encoder found	<table border="1" style="width: 100%; border-collapse: collapse;"> <tr> <td style="padding: 5px;">Connection error</td> <td style="padding: 5px;">Check the connection and correct it if necessary</td> </tr> <tr> <td style="padding: 5px;">Defective encoder cable</td> <td style="padding: 5px;">Check the cable and replace it if necessary</td> </tr> <tr> <td style="padding: 5px;">Faulty supply voltage</td> <td style="padding: 5px;">Check the supply voltage of the encoder and correct if necessary</td> </tr> <tr> <td style="padding: 5px;">Inconsistent parameterization</td> <td style="padding: 5px;">Compare the connected encoder to the parameterized encoder and correct it if necessary (H00)</td> </tr> </table>	Connection error	Check the connection and correct it if necessary	Defective encoder cable	Check the cable and replace it if necessary	Faulty supply voltage	Check the supply voltage of the encoder and correct if necessary	Inconsistent parameterization	Compare the connected encoder to the parameterized encoder and correct it if necessary (H00)
Connection error	Check the connection and correct it if necessary								
Defective encoder cable	Check the cable and replace it if necessary								
Faulty supply voltage	Check the supply voltage of the encoder and correct if necessary								
Inconsistent parameterization	Compare the connected encoder to the parameterized encoder and correct it if necessary (H00)								

Cause		Check and action
10: X4 A track/Clk, 11: X4 B track/Dat	Defective encoder cable	Check the cable and replace it if necessary
13: X4-EnDat alarm	Defective EnDat encoder	Replace the motor; EnDat 2.1 digital, EnDat 2.2 digital, EnDat 3: Fault cannot be acknowledged
14: X4 EnDat CRC, 15: X4 double transmission	Connection error	Check the connection and correct it if necessary
	Electromagnetic interference	Take EMC recommendations into account [▶ 104] and, if necessary, increase the fault tolerance (G298)
16: X4 busy	Synchronization error	Update firmware
17: EBI encoder low battery	Battery in battery module weak	Replace the battery; reference is not deleted by the event
18: EBI encoder battery empty	Battery in battery module empty	Replace the battery
	Initial connection	–
	Connection error	Check the connection and correct it if necessary
	Defective encoder cable	Check the cable and replace it if necessary
	Faulty battery module	Check the battery module and replace it if necessary
19: Alarm bit	Encoder fault	Check the specification of the encoder regarding the alarm bit
20: Resolver carrier, 21: Resolver sin/cos undervoltage, 22: Resolver sin/cos overvoltage	Defective encoder cable	Check the cable and replace it if necessary
	Incompatible encoder	Compare the specification of the encoder with the corresponding specifications from STOBER and replace the encoder or motor if necessary; fault cannot be acknowledged
21: Resolver sin/cos undervoltage	Incompatible encoder; phase search or calibration of the optimal resolver excitation failed	Compare the specification of the encoder with the corresponding specifications from STOBER; if necessary, calibrate the starting point for calibrating the optimal resolver excitation and the phase search (B40); fault cannot be acknowledged
24: Resolver failure	Defective encoder cable	Check the cable and replace it if necessary
48: X4 zero pulse missing	Defective encoder cable	Check the cable and replace it if necessary
	Connection error	Check the connection and correct it if necessary
	Late zero track	Check number of encoder increments per rotation and correct it if necessary (H02)
49: X4 zero pulse distance too small	Defective encoder cable	Check the cable and replace it if necessary
	Connection error	Check the connection and correct it if necessary
	Early zero track	Check number of encoder increments per rotation and correct it if necessary (H02)
60: Hiperface synchronisation, 61: Hiperface timeout, 62: Hiperface signal quality, 63: Hiperface link	Defective encoder cable	Check the cable and replace it if necessary
	Connection error	Check the connection and correct it if necessary
	Electromagnetic interference	Take EMC recommendations into account [▶ 104] and, if necessary, increase the fault tolerance (G298)
64: EnDat3 Timeout, 65: EnDat3 invalid Request, 66: EnDat3 Position Check	Defective encoder cable	Check the cable and replace it if necessary
	Connection error	Check the connection and correct it if necessary
	Electromagnetic interference	Take EMC recommendations into account [▶ 104] and, if necessary, increase the fault tolerance (G298)

Tab. 226: Event 77 – Causes and actions

19.1.5.35 Event 78: Position limit cyclic

The drive controller has a **fault** if:

- A29 = 0: Inactive for Drive Based or PROFIdrive device control
or
- A540 = 0: Disable drive motor coasting for CiA 402 device controller

Response:

- The power unit is disabled and axis movement is no longer controlled by the drive controller
- The brakes engage

The drive controller has a **fault with a quick stop** if:

- A29 = 1: Active for Drive Based or PROFIdrive device control
or
- A540 = 2: Slow down on quick stop ramp for CiA 402 device controller

Response:

- The axis is stopped by a quick stop
- During the quick stop, the brakes remain released
- At the end of the quick stop, the power unit is disabled and axis movement is no longer controlled by the drive controller
- The brakes engage

Information

A rising edge for the release override signal (source: F06) is expected in the Switch on disabled, Ready to switch on, and Switched on states (E48) so that the brake is released.

Cause		Check and action
1: Illegal direction	Cyclical set position outside of the software limit switch	Check the set position in the controller and software limit switch in the drive controller and correct it if necessary (PROFIdrive: I50, I51; CiA 402: A570)
2: Reference value invalid	Cyclical set position outside of the travel range	Check the set position in the controller and travel range in the drive controller and correct it if necessary (PROFIdrive: I01; CiA 402: A568)
3: Extrapolation time I423 exceeded	Missing update of the cyclical set position or cyclical set velocity	Check the task cycle time in the fieldbus MainDevice of the controller and maximum permitted extrapolation in the drive controller and correct it if necessary (I423)

Tab. 227: Event 78 – Causes and actions

19.1.5.36 Event 79: Motor/position encoder plausibility

The possible effects depend on the configured level (U28).

- 0: Inactive
- 1: Message
- 3: Fault

The drive controller has a **fault** if:

- A29 = 0: Inactive for Drive Based or PROFIdrive device control
or
- A540 = 0: Disable drive motor coasting for CiA 402 device controller

Response:

- The power unit is disabled and axis movement is no longer controlled by the drive controller
- The brakes engage

The drive controller has a **fault with a quick stop** if:

- A29 = 1: Active for Drive Based or PROFIdrive device control
or
- A540 = 2: Slow down on quick stop ramp for CiA 402 device controller

Response:

- The axis is stopped by a quick stop
- During the quick stop, the brakes remain released
- At the end of the quick stop, the power unit is disabled and axis movement is no longer controlled by the drive controller
- The brakes engage

Information

A rising edge for the release override signal (source: F06) is expected in the Switch on disabled, Ready to switch on, and Switched on states (E48) so that the brake is released.

Cause	Check and action
Connection error	Check the connection and shielding and correct them if necessary
Slip	Check the mechanics between the motor and position encoder and maximum permitted slip and correct them if necessary (I291, I292)
Mechanical damage	Check the mechanics between the motor and position encoder and correct any damage if necessary

Tab. 228: Event 79 – Causes and actions

19.1.5.37 Event 80: Illegal action

The drive controller has a **fault**:

- The power unit is disabled and axis movement is no longer controlled by the drive controller
- The behavior of the brakes depends on the configuration of the safety module

Information

A rising edge for the release override signal (source: F06) is expected in the Switch on disabled, Ready to switch on, and Switched on states (E48) so that the brake is released.

Cause		Check and action
1: Illegal	Not supported by the control type	Check the control type and correct it if necessary (B20)
2: Brake	Loaded axis	Remove the axis load and start the action again

Tab. 229: Event 80 – Causes and actions

19.1.5.38 Event 81: Motor allocation

The possible effects depend on the configured level (U04):

- 0: Inactive
- 1: Message
- 3: Fault

The drive controller has a **fault**:

- The power unit is disabled and axis movement is no longer controlled by the drive controller
- The behavior of the brakes depends on the configuration of the safety module

Information

A rising edge for the release override signal (source: F06) is expected in the Switch on disabled, Ready to switch on, and Switched on states (E48) so that the brake is released.

Depending on the cause, data for the motor (in the case of a change to the motor or motor type), current controller (in the case of a change to the motor type), brake (in the case of a change to the brake or motor type), temperature sensor (in the case of a change to the temperature sensor or motor type) or motor adapter, gear unit and geared motor (in the case of a change to the gear unit type) are read out of the electronic nameplate and entered in the respective parameters. In the event of a change to the motor, motor type or even just the commutation, the commutation offset (B05) is reset.

Cause	Check and action	
1: Different motor type	Modified motor assignment	Check the change to the motor assignment and save the new motor assignment if necessary (A00)
	Modified gear unit assignment	Check the change to the gear unit assignment and save the new assignment if necessary (A00)
32: Different motor, 33: Different motor & brake, 34: Different motor & temperature sensor, 35: Different motor & brake & temperature sensor, 38: Different motor, temperature sensor & gear unit, 64: Different commutation, 65: Different commutation & brake, 66: Different commutation & temperature sensor, 67: Different commutation & brake & temperature sensor, 129: Different brake, 130: Different temperature sensor, 131: Different brake & temperature sensor	Modified motor assignment	Check the change to the motor assignment and save the new assignment if necessary (A00)
36: Different motor & gear unit 37: Different motor, brake & gear unit, 39: Different motor, brake, temperature sensor & gear unit	Modified motor and gear unit assignment	Check the change to the motor and gear unit assignment and save the new assignment if necessary (A00)
150: Temperature sensor unknown	Motor with unknown temperature sensor type	Update the firmware or change the motor

Tab. 230: Event 81 – Causes and actions

19.1.5.39 Event 83: Failure of one/ all phases (mains)

Upon the occurrence of an event, a warning is output initially, becoming a fault after a 10 s warning period.

The drive controller has a **fault** if:

- A29 = 0: Inactive for Drive Based or PROFIdrive device control
or
- A540 = 0: Disable drive motor coasting for CiA 402 device controller

Response:

- The power unit is disabled and axis movement is no longer controlled by the drive controller
- The brakes engage

The drive controller has a **fault with a quick stop** if:

- A29 = 1: Active for Drive Based or PROFIdrive device control
or
- A540 = 2: Slow down on quick stop ramp for CiA 402 device controller

Response:

- The axis is stopped by a quick stop
- During the quick stop, the brakes remain released
- At the end of the quick stop, the power unit is disabled and axis movement is no longer controlled by the drive controller
- The brakes engage

Information

A rising edge for the release override signal (source: F06) is expected in the Switch on disabled, Ready to switch on, and Switched on states (E48) so that the brake is released.

Cause	Check and action
Failure of one or all line phases	Check the line fuse and connection and correct them if necessary

Tab. 231: Event 83 – Causes and actions

19.1.5.40 Event 84: Drop in network voltage when power section active

The event is triggered if the drive controller cannot recharge itself quickly enough via the charging resistors after a line drop when the power supply returns.

If the voltage falls below the undervoltage limit before the power supply returns, event 46: Low voltage is triggered; if the tolerance time of 10 s expires before the power supply returns, the drive controller goes into fault mode with event 83: Failure of one/ all phases (mains).

The drive controller has a **fault** if:

- U30 = 0: Inactive and
- A29 = 0: Inactive for Drive Based or PROFIdrive device control
or
- U30 = 1: Active and
- A540 = 0: Disable drive motor coasting for CiA 402 device controller

Response:

- The power unit is disabled and axis movement is no longer controlled by the drive controller
- The brakes engage

The drive controller has a **fault with a quick stop** if:

- A29 = 0: Inactive for Drive Based or PROFIdrive device control
or
- A540 = 2: Slow down on quick stop ramp for CiA 402 device controller

Response:

- The axis is stopped by a quick stop
- During the quick stop, the brakes remain released
- At the end of the quick stop, the power unit is disabled and axis movement is no longer controlled by the drive controller
- The brakes engage

The drive controller has a **fault with emergency braking** if:

- U30 = 1: Active and
- A29 = 1: Active for Drive Based or PROFIdrive device control
or
- U30 = 1: Active and
- A540 = 2: Slow down on quick stop ramp for CiA 402 device controller

Response:

- The axis is stopped by emergency braking
- The brakes engage
- At the end of emergency braking, the power unit is disabled and axis movement is no longer controlled by the drive controller

Information

Emergency braking is only possible for the synchronous servo, Lean, torque, and synchronous linear motor types.

Information

A rising edge for the release override signal (source: F06) is expected in the Switch on disabled, Ready to switch on, and Switched on states (E48) so that the brake is released.

A quick stop is not possible when the power supply returns.

Cause	Check and action
Decrease in supply voltage under load	Check the supply voltage for load stability and stabilize the network if necessary
Sporadic power failures	Check the supply voltage for stability and stabilize the network if necessary

Tab. 232: Event 84 – Causes and actions

19.1.5.41 Event 85: Excessive jump in reference value

The drive controller has a **fault** if:

- A29 = 0: Inactive for Drive Based or PROFIdrive device control
or
- A540 = 0: Disable drive motor coasting for CiA 402 device controller

Response:

- The power unit is disabled and axis movement is no longer controlled by the drive controller
- The brakes engage

The drive controller has a **fault with a quick stop** if:

- A29 = 1: Active for Drive Based or PROFIdrive device control
or
- A540 = 2: Slow down on quick stop ramp for CiA 402 device controller

Response:

- The axis is stopped by a quick stop
- During the quick stop, the brakes remain released
- At the end of the quick stop, the power unit is disabled and axis movement is no longer controlled by the drive controller
- The brakes engage

Information

A rising edge for the release override signal (source: F06) is expected in the Switch on disabled, Ready to switch on, and Switched on states (E48) so that the brake is released.

Cause		Check and action
1: Position	Fast set position change leads to acceleration that cannot be performed	Check the current set acceleration against the maximum permitted acceleration in the drive controller (E64, E69) and reduce the set value change in the controller or change the motor type if necessary
2: Velocity	Fast set velocity change leads to acceleration that cannot be performed	Check the current set acceleration against the maximum permitted acceleration in the drive controller (E64, E69) and reduce the set value change in the controller or change the motor type if necessary

Tab. 233: Event 85 – Causes and actions

19.1.5.42 Event 86: Unknown LeanMotor record

The drive controller has a **fault** if:

- A29 = 0: Inactive for Drive Based or PROFIdrive device control
or
- A540 = 0: Disable drive motor coasting for CiA 402 device controller

Response:

- The power unit is disabled and axis movement is no longer controlled by the drive controller
- The brakes engage

The drive controller has a **fault with a quick stop** if:

- A29 = 1: Active for Drive Based or PROFIdrive device control
or
- A540 = 2: Slow down on quick stop ramp for CiA 402 device controller

Response:

- The axis is stopped by a quick stop
- During the quick stop, the brakes remain released
- At the end of the quick stop, the power unit is disabled and axis movement is no longer controlled by the drive controller
- The brakes engage

Information

A rising edge for the release override signal (source: F06) is expected in the Switch on disabled, Ready to switch on, and Switched on states (E48) so that the brake is released.

Cause		Check and action
1: Motor	Motor type not supported by firmware	Update the firmware or change the motor (B100)
2: Cable length	Cable length not supported by firmware	Update the firmware or change the cable (B101)

Tab. 234: Event 85 – Causes and actions

19.1.5.43 Event 87: Reference lostReference loss

A reference loss is issued as a message only.

Cause	Check and action
Power unit switched off on moving axis	Reference the drive again and, if necessary, only shut off the power unit at standstill (I199)
Actual position (motor) changes when power unit is shut off	Do not change the actual position (motor) when the power unit is shut off and, if applicable, switch to a motor with a brake (F00)

Tab. 235: Event 87 – Causes and actions

19.1.5.44 Event 88: Control panel

The drive controller has a **fault** if:

- A29 = 0: Inactive for Drive Based or PROFIdrive device control
or
- A540 = 0: Disable drive motor coasting for CiA 402 device controller

Response:

- The power unit is disabled and axis movement is no longer controlled by the drive controller
- The brakes engage

The drive controller has a **fault with a quick stop** if:

- A29 = 1: Active for Drive Based or PROFIdrive device control
or
- A540 = 2: Slow down on quick stop ramp for CiA 402 device controller

Response:

- The axis is stopped by a quick stop
- During the quick stop, the brakes remain released
- At the end of the quick stop, the power unit is disabled and axis movement is no longer controlled by the drive controller
- The brakes engage

Information

A rising edge for the release override signal (source: F06) is expected in the Switch on disabled, Ready to switch on, and Switched on states (E48) so that the brake is released.

Cause	Check and action
Commissioning and parameterization computer heavily loaded	Check and, if necessary, reduce the number of open windows (DS6) and the number of active programs
Connection error	Check the connection and correct it if necessary
Defective network cable	Check the cable and replace it if necessary
Faulty network connection	Check the network settings and, if applicable, the switch, router or wireless connections and correct them or contact your network service provider if necessary

Tab. 236: Event 88 – Causes and actions

19.1.5.45 Event 89: Maximum current LM

The drive controller has a **fault** if:

- A29 = 0: Inactive for Drive Based or PROFIdrive device control
or
- A540 = 0: Disable drive motor coasting for CiA 402 device controller

Response:

- The power unit is disabled and axis movement is no longer controlled by the drive controller
- The brakes engage

The drive controller has a **fault with a quick stop** if:

- A29 = 1: Active for Drive Based or PROFIdrive device control
or
- A540 = 2: Slow down on quick stop ramp for CiA 402 device controller

Response:

- The axis is stopped by a quick stop
- During the quick stop, the brakes remain released
- At the end of the quick stop, the power unit is disabled and axis movement is no longer controlled by the drive controller
- The brakes engage

Information

A rising edge for the release override signal (source: F06) is expected in the Switch on disabled, Ready to switch on, and Switched on states (E48) so that the brake is released.

Cause	Check and action
1: Id, 2: Iq	Excessive controller gain at low speeds Check the controller coefficients and speed controller factors and reduce them if necessary (I19, C31, B146, B147)

Tab. 237: Event 89 – Causes and actions

19.1.5.46 Event 90: Motion block

The drive controller has a **fault** if:

- A29 = 0: Inactive for Drive Based or PROFIdrive device control
or
- A540 = 0: Disable drive motor coasting for CiA 402 device controller

Response:

- The power unit is disabled and axis movement is no longer controlled by the drive controller
- The brakes engage

The drive controller has a **fault with a quick stop** if:

- A29 = 1: Active for Drive Based or PROFIdrive device control
or
- A540 = 2: Slow down on quick stop ramp for CiA 402 device controller

Response:

- The axis is stopped by a quick stop
- During the quick stop, the brakes remain released
- At the end of the quick stop, the power unit is disabled and axis movement is no longer controlled by the drive controller
- The brakes engage

Information

A rising edge for the release override signal (source: F06) is expected in the Switch on disabled, Ready to switch on, and Switched on states (E48) so that the brake is released.

Cause		Check and action
1: Next motion block missing	Subsequent motion block for motion block with final velocity is missing	Define buffered subsequent motion block
2: Target Position in reverse direction	Set position is in the opposite direction	A change of travel direction by the subsequent motion block is not permitted for motion blocks with final velocity; adjust the set position
	Set position cannot be reached without reversing	Check limiting values for velocity, deceleration and jerk and adjust if necessary

Tab. 238: Event 90 – Causes and actions

19.2 SX6 safety module

In case of a fault, the two diagnostic parameters S02 and S03 supply detailed information about the type of fault or the corresponding cause using error codes.

19.2.1 Parameters

The following parameters are available for diagnosing the safety technology in combination with the SX6 safety module.

- S00 Safety module status code axis
- S01 Safety module status code
- S02 Safety module active error code channel A
- S03 Error code channel B

19.2.2 Error codes

The SX6 safety module has an extensive internal diagnostic system.

The table only lists error codes that you can influence. Internal errors which you have no influence over can only be acknowledged by restarting the drive controller. If such an error occurs repeatedly, please contact our System Support.

Information

Make sure that your EtherCAT system is running without errors. If necessary, rectify errors involving the EtherCAT system first (see [EtherCAT state](#) [▶ 249]).

The code specified in column 1 corresponds to the first four digits of the error code.

Code	Cause	Check and action
0101 hex	SS1 – Limit value violation of configured brake ramp monitoring	Check configured position error for brake ramp monitoring
0201 hex	SS2 – Limit value violation of configured standstill monitoring	<ul style="list-style-type: none"> ▪ Check configured position window for standstill ▪ Prevent movements if SOS is active
0202 hex	SS2 – Limit value violation of configured brake ramp monitoring	Check configured position error for brake ramp monitoring
0301 hex	SOS – Limit value violation of configured standstill monitoring	<ul style="list-style-type: none"> ▪ Check configured position window for standstill ▪ Prevent movements if SOS is active
0401 hex	SLS – Limit value violation of configured velocity or tolerance range (tolerance time)	<ul style="list-style-type: none"> ▪ Check configured limit value of velocity and tolerance time (t_1) ▪ Ensure that the current velocity of the axis does not exceed the limit value
0402 hex	SLS – Limit value violation of configured tolerance range (tolerance period)	<ul style="list-style-type: none"> ▪ Check configured tolerance period (t_2) ▪ Ensure that the current velocity of the axis does not exceed the tolerance time
0403 hex	SLS – Limit value violation of the configured tolerance range (tolerance window)	<ul style="list-style-type: none"> ▪ Check configured tolerance window (Tol_{win}) ▪ Ensure that the current velocity of the axis does not exceed the tolerance window

Code	Cause	Check and action
0406 hex	SLI – Limit value violation of the increment	<ul style="list-style-type: none"> Check configured lower and upper position limit Ensure that the increment of the motor does not exceed the limit value
0408 hex	SLP – Limit value violation of configured position range	<ul style="list-style-type: none"> Check configured lower and upper position limit Check the absolute position of the motor
0501 hex	SSR – Limit value violation of configured velocity range or tolerance range (tolerance time)	<ul style="list-style-type: none"> Check configured lower and upper velocity limit and tolerance time (t_1) Ensure that the current velocity of the axis does not leave the defined velocity range
0502 hex	SSR – Limit value violation of configured tolerance range (tolerance period)	Check configured tolerance period (t_2)
0503 hex	SSR – Limit value violation of configured tolerance range (tolerance window)	Check configured tolerance window (Tol_{win})
0601 hex	SDI – Limit value violation of direction of motion (positive)	<ul style="list-style-type: none"> Check the motor's direction of motion Monitor the desired direction of motion Check configured window of standstill position
0602 hex	SDI – Limit value violation of direction of motion (negative)	<ul style="list-style-type: none"> Check the motor's direction of motion Monitor the desired direction of motion Check configured window of standstill position
0701 hex	SBT – Limit value violation of standstill position BD1/BD2 (brake 1)	<ul style="list-style-type: none"> Ensure that the brake is functioning properly Ensure that the test current is set correctly
0702 hex	SBT – Limit value violation of standstill position SBC+/- (brake 2)	<ul style="list-style-type: none"> Ensure that the brake is functioning properly Ensure that the test current is set correctly
0703 hex	SBT – Limit value violation of standstill position (e.g. wait time)	<ul style="list-style-type: none"> Ensure that the brakes are wired properly Ensure that the brakes are functioning properly Ensure that the drive controller engages its brake as expected
0704 hex	SBT – Limit value violation of configured test current within the test step	<ul style="list-style-type: none"> Ensure that the wiring of the motor is free from errors Check drive controller settings (e.g. parameter for current and velocity control)
0705 hex	SBT – Faulty brake state	<ul style="list-style-type: none"> Ensure that the brakes are wired properly Check settings of SBC function and brake test Check drive controller settings (e.g. parameter for current and velocity control)
0706 hex	SBT – Brake test cancellation	Carry out brake test again

Code	Cause	Check and action
0707 hex	SBT – Brake test cancellation by the drive controller	<ul style="list-style-type: none"> Carry out brake test again Check drive controller settings (e.g. parameter for current and velocity control)
0708 hex	SBT – Timeout of configured test period	<ul style="list-style-type: none"> Check test period and tolerance time Carry out brake test
0709 hex	SBT – Timeout of configured total time	<ul style="list-style-type: none"> Check configuration of brake test Check drive controller settings (e.g. parameter for current and velocity control)
070A hex	SBT – Timeout in communication with the drive controller	<ul style="list-style-type: none"> Check configuration of brake test Check drive controller settings (e.g. parameter for current and velocity control)
070B hex	SBT – Brake test not configured	Check settings of brake test for activated test steps
0801 hex	SBC – Timeout of configured time in feedback control (FBK)	<ul style="list-style-type: none"> Check the configured activation delay (Ton), deactivation delay (Toff) of the feedback control Check correct connection of brake output and feedback signal
0802 hex	SBC – Faulty feedback status	<ul style="list-style-type: none"> Check settings of SBC safety function for correct type (1: normally open (N/O), 2: normally closed (N/C)) Check correct connection of brake output and feedback signal
1201 hex	Error in the plausibility check of the motor encoder due to current signal	<ul style="list-style-type: none"> Check reactive current settings Check drive controller settings (e.g. parameter for current and velocity control) Check the system for possible interference frequencies (power supply unit, transformer, etc.) and for correct shielding Prevent external influences on the system that may result in adjustment of the motor, for example, and thus current peaks Check motor encoder for proper function
1202 hex	Error in the plausibility check of the motor encoder due to current signal	<ul style="list-style-type: none"> Check reactive current settings Check drive controller settings (e.g. parameter for current and velocity control) Check the system for possible interference frequencies (power supply unit, transformer, etc.) and for correct shielding Prevent external influences on the system that may result in adjustment of the motor, for example, and thus current peaks Check motor encoder for proper function

Code	Cause	Check and action
1203 hex	Error in the plausibility check of the motor encoder due to current signal (direction of motion)	<ul style="list-style-type: none"> ▪ Check drive controller settings (e.g. parameter for current and velocity control) ▪ Check settings of motion and acceleration profiles (change of direction of motion may be too fast) ▪ Check motor encoder for proper function
1301 hex	Error in the plausibility check of external encoder	Check settings and function of the external encoder
1302 hex	Error due to signal overrun in the motor encoder or in the external encoder	Adjust the mechanical travel range and permitted value range of the encoder
1303 hex	Error in the plausibility check of velocity	<ul style="list-style-type: none"> ▪ Check settings of the safety module (motor, encoder, etc.) ▪ Check motor encoder for proper function
1305 hex	Error in the plausibility check of external encoder	Check settings and function of the external encoder
1308 hex	Error in the plausibility check of external encoder velocity	<ul style="list-style-type: none"> ▪ Check settings and function of the external encoder ▪ Check settings of the safety module (motor, encoder, etc.)
1309 hex	Error in the plausibility check of external encoder absolute position	<ul style="list-style-type: none"> ▪ Check settings and function of the external encoder ▪ Check settings of the safety module (motor, encoder, etc.)
130A hex	Error in the settings of the external encoder	<ul style="list-style-type: none"> ▪ Check settings and function of the external encoder ▪ Check settings of the drive controller and safety module
1401 hex	No match for number of poles	Check number of poles in the configuration of the safety module and drive controller
1402 hex	No match for motor type	Check motor type in the configuration of the safety module and drive controller
1403 hex	No match for motor brake	Check settings of the brake of the safety module and drive controller
1404 hex	No match for number of drive axes	<ul style="list-style-type: none"> ▪ Check project configuration ▪ Check safety configuration
1501 hex	Faulty configuration file; file cannot be opened	Check safety configuration
1502 hex	Faulty configuration file; file cannot be opened	Check safety configuration
1503 hex	Faulty configuration file; file has an invalid format	Check safety configuration
1504 hex	Faulty configuration file; parameter specification missing	Check safety configuration
1505 hex	Faulty configuration file; parameter specification invalid	Check safety configuration
1506 hex	Faulty configuration file; parameter check fails	Check safety configuration
1507 hex	Faulty configuration file; invalid number of safety functions	Check safety configuration

Code	Cause	Check and action
1508 hex	Faulty configuration file; maximum number of safety functions exceeded	Check safety configuration
1509 hex	Faulty configuration file; parameter check fails	Check safety configuration
150A hex	Faulty configuration file; file does not exist	Download configuration
150B hex	Timeout when downloading the configuration file	Check safety configuration
150C hex	Faulty configuration file; file is too large	Check safety configuration
150E hex	Faulty configuration file; module description not available	Check module description
150F hex	Faulty configuration file; multiple module descriptions	Check module description
1510 hex	Faulty configuration file; invalid checksum	Check safety configuration
1511 hex	Faulty configuration file; invalid checksum	Check safety configuration
1512 hex	Device replacement failed	Perform process again and proceed exactly according to instructions
1513 hex	Timeout for device replacement; confirmation by user not entered in time	Perform process again and confirm the device replacement within the specified time
1514 hex	Faulty user input during device replacement	Perform process again and proceed exactly according to instructions
1515 hex	Cancellation of device replacement during user confirmation	Perform process again and do not cancel the device replacement
1516 hex	Faulty configuration file; invalid safety function entry	Download configuration
1601 hex	A subsequent fault has occurred	Rectify error which occurred first
1607 hex	Incorrect material or serial number	<ul style="list-style-type: none"> ▪ Carry out download again ▪ Check material and serial number
160A hex	Error when starting the safety module	Restart
1704 hex	Faulty synchronization with drive controller	Check whether the valid, appropriate drive controller firmware is present (E52[3])
1901 hex	Error when writing to memory (FLASH)	Carry out procedure again
1902 hex	Error when deleting the memory (FLASH)	Carry out procedure again
1903 hex	Error when writing to memory (EEPROM)	Carry out procedure again
1904 hex	Error when reading from memory (EEPROM)	Carry out procedure again
1A14 hex	Invalid FSoE SubInstance address	Check FSoE address of the SubInstance (valid value range: 1-254)
1A16 hex	Error during FSoE communication; FSoE error occurred	Check FSoE watchdog time
1D01 hex	Error in a digital input	Ensure that the connection wiring of the input is free from errors
1D02 hex	Error in a digital output	<ul style="list-style-type: none"> ▪ Ensure that there is no short-circuit, cross-circuit fault or wire break in the connecting wiring of the output ▪ Restart
1D03 hex	Error when reading back a digital output	Ensure that there is no short-circuit, cross-circuit fault or wire break in the connecting wiring of the output

Code	Cause	Check and action
1D04 hex	Error in an SBC output	Ensure that there is no short-circuit, cross-circuit fault or wire break in the connecting wiring of the output
1D05 hex	Error when reading back an SBC output	Ensure that there is no short-circuit, cross-circuit fault or wire break in the connecting wiring of the output
1D06 hex	Faulty supply voltage	Check supply voltage of the safety module
1D07 hex	Faulty supply voltage	Check supply voltage of the safety module
1D08 hex	Supply voltage of digital outputs is not present	Check supply voltage of the outputs
1D09 hex	Supply voltage test for digital outputs failed	Check supply voltage of the outputs
1D0A hex	Faulty supply voltage	Check supply voltage of the safety module
1D0C hex	Faulty supply voltage	Check supply voltage of the safety module

Tab. 239: Error list of the SX6 safety module

19.3 Acknowledging faults

There are several options for acknowledging faults. As a rule, an acknowledgement is also transmitted to the safety module.

Application-independent

Irrespective of the application, you can acknowledge faults via the control panels in DriveControlSuite.

Drive Based application

In the Drive Based application, the following options for acknowledging are available in DriveControlSuite:

- By defining the source of the signal in A61 (source: digital input or control byte A180, bit 1)
- By additional enable signal via A60 (source: digital input or control byte A180, bit 0)

The drive controller has a configurable restart (A34) in the Drive Based application.



WARNING!

Injury to persons and material damage due to unexpected motor startup!

Only activate autostart if the standards and regulations applicable to the system or machine in question permit a direct switch to the Ready to switch on device state.

- In accordance with EN 61800-5-1, clearly mark an activated autostart on the system and in the associated system documentation.

CiA 402 application

In the CiA 402 application, you can acknowledge faults in DriveControlSuite using control word A515, bit 3 (Enable operation) or bit 7 (Fault reset).

PROFIdrive application

In the PROFIdrive application, you can acknowledge faults in DriveControlSuite using control word M515, bit 3 (Enable operation) or bit 7 (Fault acknowledge).

20 Analysis

Scope and multi-axis scope in DriveControlSuite are two analysis tools that help you commission single axes or entire machines and troubleshoot.

You can select and record up to 12 parameters from the entire pool of drive controller parameters. The sampling time can be set from 250 μ s to several seconds to be able to observe both highly dynamic as well as very slow processes. Like for an actual oscilloscope, there are a variety of trigger options and many statistical evaluation functions for the recorded data (minimum value, maximum value, average, RMS value, standard deviation, etc.).

Tool	Objectives	Application cases
Scope	Create multiple scope images of a single drive controller at different times.	Optimize or diagnose a drive controller
	Create multiple scope images with the same settings (channels, trigger, pre-trigger, sampling time), but differing values for individual parameters.	
	Combine multiple scope images for the analysis.	
	Create a temporary direct image.	
Multi-axis scope	Create individual scope images of multiple drive controllers or axes at the same time.	Check the machine utilization or diagnosis in synchronous operation
	Create an individual scope image with the same settings or individual settings (for each axis or for individual axes).	

Tab. 240: Application cases for scope and multi-axis scope

20.1 Scope and multi-axis scope

With the Scope and Multi-axis scope windows, you can create scope images for diagnostic purposes for one or more drive controllers if an online connection is established.

Information

The Scope window can be reached using the button in the project menu if you have selected a drive controller in the project tree.

The Multi-axis scope window can be reached using the button in the project menu if you have selected the project in the project tree.

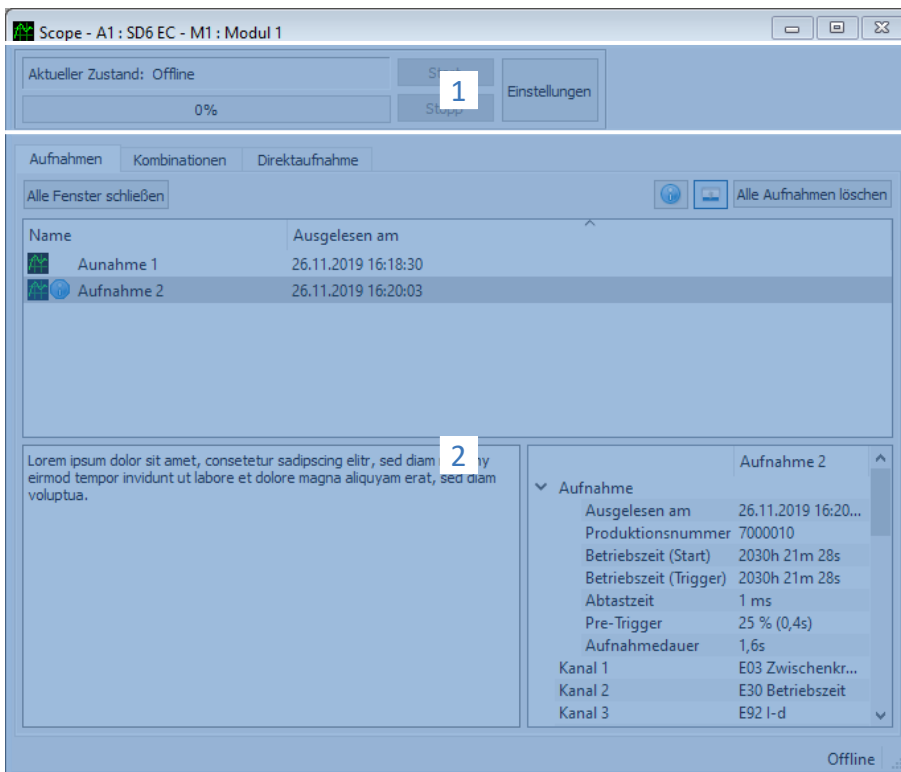



Fig. 71: Scope and multi-axis scope: Program interface

No.	Area	Description
1	Action area	In the Action area, you can define settings for the scope image, start and stop the scope image, and read information on the status, scope image progress and remaining recording time.
2	Scope images	In the Images area, you can open, delete, rename, comment on or export scope images that have already been read out. In the scope, the Combinations and Direct image tabs are also available in this area.

Action area: Buttons

Button	Availability	Description
Start	Scope, multi-axis scope	Starts the scope image (prerequisite: online connection).
Stop	Scope, multi-axis scope	Stops the scope image (prerequisite: online connection).
Settings	Scope, multi-axis scope	Opens the Settings window where you can define the trigger condition, channel assignment, sampling time and, in the case of the multi-axis scope, the nodes for the scope image.

Scope images: Buttons

Icon	Description
	Opens the dialog box for storing a comment for the scope image.
	Shows/hides the bottom margin area.

Information

If you want to learn more about a particular scope image, click on it. Any comments and the properties of the scope image are then displayed at the bottom of the window. You can show the lower margin area using the button in the **Scope images** or **Combinations** tab.

Button	Description
Close all windows	Closes all open scope images and combinations.
Delete all scope images	Deletes all individual scope images; combined scope images are retained (tab: Scope images).
Delete all combinations	Deletes all combined scope images; individual scope images are retained (tab: Combinations).

Scope images: Context menus

Tab	Availability	Description	Context menu
Scope images	Scope	On the Images tab, completed scope images are listed after being read out from the drive controller. Double-click to open the scope image. If you have created multiple scope images and select this, you can combine and open them via the context menu.	<ul style="list-style-type: none"> ▪ Open ▪ Delete ▪ Rename ▪ Comment ▪ Export ▪ Combine and open
	Multi-axis scope	On the Images tab, completed scope images are listed after being read out from the drive controller. Double-click to open the scope image.	<ul style="list-style-type: none"> ▪ Open ▪ Delete ▪ Rename ▪ Comment ▪ Export
Combinations	Scope	On the Combinations tab, combined scope images are listed that you can open by double-clicking.	<ul style="list-style-type: none"> ▪ Open ▪ Delete ▪ Rename ▪ Comment ▪ Export
Direct image	Scope	In the Direct image tab, you can create a temporary scope image that is discarded with the start of the next scope image and use the set value generation to optimize the control cascade.	—

20.1.1 Scope settings

In the Settings window, you define the settings for the scope image and the trigger before you start the scope image. The scope image settings are shown in the Channel assignment tab, the trigger settings in the Trigger condition tab (scope) or Node and trigger condition tab (multi-axis scope).

Information

The Settings window for scope images can be reached via the Settings button in the Scope or Multi-axis scope window.

Tab	Availability	Description
Channel assignment	Scope, multi-axis scope	With the scope image settings in the Channel assignment tab, you define which data of the respective axis you want to record in the scope image, in which time intervals the data is sampled and which time period is recorded before triggering the trigger.
Trigger condition	Scope	With the trigger settings in the Trigger condition tab, you define which event triggers the recording of a scope image.
Node and trigger condition	Multi-axis scope	With the trigger settings in the Node and trigger condition tab, you define which event triggers the recording of a scope image and for which axes a scope image is recorded.

Example: Trigger and scope image settings

Settings	Example	Results
Trigger settings	<ul style="list-style-type: none"> ▪ Simple trigger ▪ Source: E15 v-motor-encoder ▪ Condition: greater ▪ Comparison value: 50 rpm 	The trigger condition is met if the value of parameter E15 v-motor-encoder is greater than 50 rpm.
Scope image settings	<ul style="list-style-type: none"> ▪ Recorded channels: 1 ▪ Sampling time: 1 ms ▪ Pre-trigger: 33% 	The recording time calculated from the number of channels and the sampling time is 6.6 s. 2.2 s (33%) are recorded before the trigger is triggered and 4.4 s afterwards.

Information

Additional settings for your scope images can be made using parameters T25 Automatic start and T26 Retrigger scope.

20.1.1.1 Trigger settings

With the trigger settings in the **Trigger condition** tab (scope) or **Node and trigger condition** tab (multi-axis scope), you define which event triggers the recording of a scope image. To do this, define the trigger for each axis and, if applicable, the trigger condition. The selection of the trigger influences which of the settings described below are available to you.

Information

The **Settings** window for the scope image can be reached via the **Settings** button in the **Scope** or **Multi-axis scope** window. For the scope, you can find the trigger settings directly in the **Trigger condition** tab. For the multi-axis scope, you can reach the trigger settings for the respective axis via the **Settings** button in the **Node and trigger condition** tab.

Trigger	Description
Manually at stop	The trigger is triggered by the Stop button, without taking the pre-trigger time into account.
Immediately at start	The trigger is triggered by the Start button as soon as the pre-trigger time has elapsed.
Simple trigger	The trigger is triggered automatically when the trigger condition is met and the pre-trigger time has elapsed.
Trigger logic	The trigger is triggered automatically when the trigger logic is satisfied and the pre-trigger time has elapsed.

Trigger conditions

A simple trigger consists of a single trigger condition, while trigger logic is composed of 2 trigger conditions logically linked by an operator. A trigger condition consists of the source, the condition and the comparison value.

Source	Description
Inactive	Default value if Manually at stop was selected as the trigger.
Immediately at start	Default value if Immediately at stop was selected as the trigger.
Parameter	Defines a parameter as the source for the trigger. You can enter the parameter either via the [...] button and Add parameter dialog box or directly into the text field with auto-completion by specifying the coordinate, name and, if applicable, axis number (example: 1.180 Current position).
Signal name	Defines a signal as the source for the trigger. You have assigned a signal name for this signal in the graphical programming at the input or output of a block. If you have not yet assigned a signal name in the graphical programming, the list is empty.
Physical address	Defines a physical address in the drive controller memory as the source for the trigger. Physical addresses can be assigned as part of an extended diagnosis by the development team. They must be specified with the associated data type.

Information

If you record the value of a parameter or use a parameter as a trigger source, you can display the associated parameter description as a tooltip in both the scope image settings and the trigger settings (button: ).

Setting	Description
Condition	Condition for the trigger condition with which the source and the comparison value are compared. <ul style="list-style-type: none"> less than less than or equal to greater than greater than or equal to equal to not equal to
Comparison value	Comparison value for the trigger condition that is compared to the source.
Minimum time	Time, in μs , in which the condition must at least be met for the trigger condition to be considered met.

Option	Description
Absolute value	The Absolute value option enables you to ignore the sign when comparing the source and comparison value.
Mask	The Mask option allows you to evaluate only a single bit of the source.
Edge	The Edge option activates/deactivates edge detection.

Information

You can switch the display of the **Mask** option between hexadecimal and binary display if required. The mask is displayed with leading zeros according to the data type or data width of the selected parameter.

Operator	Description
AND	The trigger logic is satisfied if both trigger conditions are met.
OR	The trigger logic is satisfied if one or both trigger conditions are met.
XOR	The trigger logic is satisfied if one of the two trigger conditions is met, not both .
NAND	The trigger logic is satisfied if neither or one of the two trigger conditions is met, not both .
NOR	The trigger logic is satisfied if neither of the two trigger conditions is satisfied.
XNOR	The trigger logic is satisfied if neither or both of the two trigger conditions are met.
Trigger 1	The trigger logic is satisfied if the first trigger condition is met.
Trigger 2	The trigger logic is satisfied if the second trigger condition is met.

Button	Description
Export	Exports all settings (trigger and scope image settings) to a text file (*.txt).
Import	Imports all settings from a text file (*.txt).
Close	Closes the window. All settings are accepted.

Information

Export your settings if you want to reuse the same or similar settings in other projects or import existing settings and adjust them as necessary.

20.1.1.2 Scope image settings

With the scope image settings in the Channel assignment tab, you define which data of the respective axis you want to record in the scope image, in which time intervals the data is sampled and which time period is recorded before triggering the trigger. To do this, define the channel assignment, the sampling time and the pre-trigger for each axis.

Information

The Settings window for the scope image can be reached via the Settings button in the Scope or Multi-axis scope window. For the scope and multi-axis scope, the scope image settings are shown in the Channel assignment tab.

Information

For a multi-axis scope, you must first select at least 2 nodes before you can specify the settings in the Channel assignment tab. You can specify identical channel assignments for all axes or use the Individual option to store differing settings for each axis. The calculation of the recording time and pre-trigger time relate to the axis with the shortest recording time.

Setting	Selection	Description
Channel assignment	Inactive	When Inactive is selected, no value is recorded in the scope image for the channel.
	Parameters	When Parameter is selected, the value of a parameter is recorded in the scope image for the channel.
	Signal names	When Signal name is selected, the value of a signal is recorded in the scope image for the channel. You defined a signal name for this signal in the graphic programming at the input or output of a block.
	Physical address	When Physical address is selected, the value of a physical address in the memory of the drive controller is recorded in the scope image for the channel.
Sampling time	250 µs - 100 ms	With the Sampling time setting, you define the time interval in which the signals are sampled for the scope image.
Pre-trigger	0 % – 100 %	With the Pre-Trigger setting, you define the percentage of the scope memory that must be occupied for the axis to be trigger-ready and thus the percentage of the recording time before the trigger.

Information

If you record the value of a parameter or use a parameter as a trigger source, you can display the associated parameter description as a tooltip in both the scope image settings and the trigger settings (button: .

Information

The scope memory has approximately 32 KB available for the scope image. The recording time is calculated from the sampling time, the number of recorded channels and the available disk space. The larger the number of recorded channels and the more frequently the channels are sampled, the faster the available disk space is occupied and the shorter the scope image becomes.

The pre-trigger time is calculated from the set pre-trigger and the recording time.

Information

If a large pre-trigger value is entered with a long recording time, the scope image may remain in the Started state for a period after the start until the pre-trigger is fulfilled and recording readiness is signaled by the Trigger-ready state. Status and progress of the scope image are displayed in DriveControlSuite. The scope image is then read out from the drive controller and transmitted to DriveControlSuite.

Button	Description
Export	Exports all settings (trigger and scope image settings) to a text file (*.txt).
Import	Imports all settings from a text file (*.txt).
Close	Closes the window. All settings are accepted.

Information

Export your settings if you want to reuse the same or similar settings in other projects or import existing settings and adjust them as necessary.

20.1.2 Image editor

The image editor contains all the functions you need to edit your scope images.

Information

The image editor can be reached by double-clicking a scope image or via the context menu of the respective scope image.

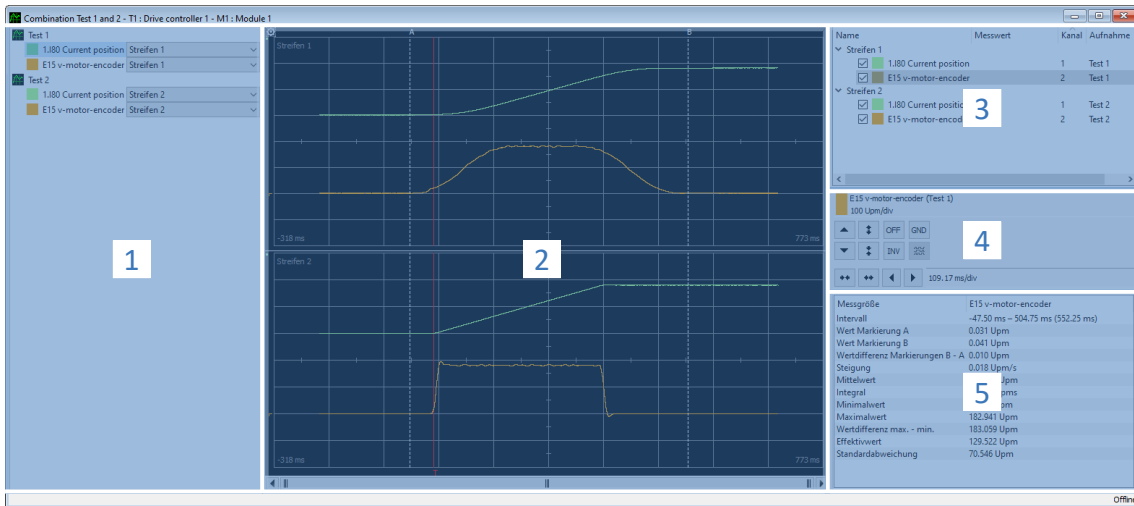

Fig. 72: Scope and multi-axis scope: Image editor



No.	Area	Description
1	Assignment of channel to band	For combinations or multi-axis scope images, you can change the assignment to a section within the scope image (= band) for each channel in the Channels and bands area.
2	Scope image	In the Scope image area, you see the graphical representation of the recorded and visible channels.
3	Channel selection	In the Channel selection area, you manage the bands and channels of a scope image.
4	Channel settings	In the Channel settings area, you can adjust the graphical representation of the channels.
5	Measured values	In the Measured values area, values for different measured variables are output with measuring points A and B for the selected channel. For scope images, there is also the option to carry out a frequency analysis.



Assignment of channel to band

This area is only available in case of combinations or multi-axis scope images. By default, each scope image is assigned a band with the recorded channels. You can hide each channel (parameter, signal name or physical address) or change the assignment to a band via the corresponding picklist. However, new bands must be created beforehand in the Channel selection area.

Scope image

A scope image shows a graphical representation of the recorded and visible channels.

Icon/Button	Description	Context menu
	Left-clicking on measuring line A or B allows the line to be shifted to the left or right as desired.	—
[Right mouse button]	Right-clicking on any point of the scope image opens the context menu.	<ul style="list-style-type: none"> ▪ Set marking A here ▪ Set marking B here ▪ Jump to marking A ▪ Jump to marking B
[Left mouse button]	Left-clicking on any point of the scope image activates the quick measurement. The values are output in the Channel selection area in the Measured value column.	—
	Marking the zero line of a channel.	—
	Marking the trigger line.	—

Icon	Description
	Opens the image editor settings for the coloring of the drawing area and channels.
	Opens the dialog box for storing a comment for the scope image.
	Opens the list of scope images in order to take over the channel scaling from a scope image that has already been adjusted. Button only available for scope images, not for combinations or multi-axis scope images.













Channel selection

In the Channel selection area, you manage the bands and the channels assigned to them. You can delete existing bands or create new bands. You can activate or deactivate the display of a channel. For each channel, a channel number and the name of the scope image is output. If you click any point within the scope image, the associated measured value is also displayed.

Element	Description	Context menu
Band	Section of a scope image	<ul style="list-style-type: none"> ▪ Delete band ▪ Create new band
Channel	Recorded parameter, signal name or physical address	<ul style="list-style-type: none"> ▪ Hide channel ▪ Only show this channel ▪ Show all channels ▪ Invert display of channels ▪ Create new band

Channel settings

The channel settings are used to adjust the graphical representation of the channels and scope image. In the display above the buttons, you see the color, complete designation and scaling of the selected channel. You can use the buttons to change the display of the channel or time axis. In the display next to the button for the time axis, the current scaling of the x-axis is displayed.

Button	Section	Description
	Channel display	Opens the color palette for changing the channel color.
 	Channel settings	Moves the curve of the activated channel up or down by a grid interval: <ul style="list-style-type: none"> ▪ [Shift] + [button]: Moves curve up or down by a pixel ▪ [Ctrl] + [button]: Moves curve up or down to the next grid line ▪ [Shift] + [Ctrl] + [button]: Centers curve vertically
 		Enlarges or reduces the channel scaling (fixed point = horizontal image center): <ul style="list-style-type: none"> ▪ [Shift] + [button]: Autoscaling
		Displays or hides the channel.
		Inverts the channel display.
		Indicates the zero line of the channel.
		Opens the list of parameter signals for selecting an individual bit. Button can only be used for whole-number parameters without decimal places (BYTE, WORD or DWORD data types), but not for selection parameters.
 		Time axis settings
 	Moves the scope image left or right by a grid interval: <ul style="list-style-type: none"> ▪ [Shift] + [button]: Moves scope image left or right by a pixel ▪ [Ctrl] + [button]: Moves scope image left or right to the next grid line ▪ [Shift] + [Ctrl] + [button]: Centers scope image horizontally 	

Information

You can use the buttons in the channel settings to scale both the channel (y-axis) and time axis (x-axis) in steps. Alternatively, you can freely scale both axes by entering the desired scaling factor directly in the respective field. Also define the desired unit for the time axis (ns, μs/us, ms, s).

Free channel scaling makes it easier to compare channels or parameters with different scaling, e.g. for comparing set and actual values. To convert between motor and user sizes, you can either view the scaling factor in parameter I240 or use the scaling calculator (wizard: Axis: Scaling).

Measured values

In the Measured values area, values for different measured variables are output with measuring points A and B for the selected channel. For scope images, there is also the option to carry out temporary frequency analyses in the form of a discrete Fourier transform (DFT). When the image editor is closed, DFT calculations are discarded again.

Tab	Availability	Description
Scope	Scope, multi-axis scope	The Scope tab has a list of the values for various variables referring to measuring points A and B for the selected channel.
Frequency analysis	Scope	The Frequency analysis tab can be used for performing Fourier transforms on scope images.

20.1.3 Frequency analysis

Between measuring points A and B in the Frequency analysis tab of the image editor, a blue transparent window appears for which a discrete Fourier transform can be carried out. Interval and measured values (= number of sensing points between A and B) are displayed for you.

Information

You can reach the tab where you can carry out a frequency analysis in the image editor of a scope image through the Measured values area > Frequency analysis tab.

Setting	Selection	Description
Window function	Hamming	Minimizes the leakage effect for the Fourier transform.
	Without weighting	Calculation without correction.

Button	Description
Calculate DFT	The DFT is calculated and opened in a separate window.

DFT window

The calculated DFT opens in a separate window. When the window is closed, the calculation is discarded again. You can adjust the display:

- [Ctrl] + [Left mouse button]: Zoom in on section
- [Ctrl] + [Right mouse button]: Reset display to initial value (100%)

Button	Description
OFF	Displays or hides the selected channel.
Log	Logarithmically scales the y- or x-axis.
Lin	Linearly scales the y- or x-axis.

20.2 Scope image

Scope image recording is divided into 3 steps:

- Preparation of the scope image in DriveControlSuite
 - Establish online connection
 - Configure channels of the participating axis
 - Define trigger settings
 - Start the scope image
- Loading the data in the drive controller
 - Process of trigger communication (independent of DriveControlSuite)
 - Monitor the scope image with DriveControlSuite
- Reading out and displaying the scope image
 - Read the scope image out of the drive controller
 - Display the scope image in DriveControlSuite

20.2.1 Creating a scope image

Create a scope image by specifying the scope image and trigger settings. Then start the scope image with an existing online connection.

Information

To create a scope image with the scope or multi-axis scope, you need an online connection between DriveControlSuite and the drive controller. You can establish the online connection either before or after defining the scope image and trigger settings.

Define the settings for scope images and triggers

Define the scope image settings and the trigger settings before you start the scope image.

1. Select the relevant drive controller in the project tree and click **Scope** in the project menu.
 - ⇒ The **Scope** window opens.
2. Action area:

To define the settings for the scope image, click **Settings**.

 - ⇒ The **Settings** window opens.
3. **Trigger condition tab:**

Define which event triggers the scope image.

 - 3.1. Select **Manual at stop** to activate the trigger via the **Stop** button (without pre-trigger).
 - 3.2. Select **Immediately at start** to activate the trigger via the **Start** button (with pre-trigger).
 - 3.3. Select **Simple trigger** to activate the trigger automatically when a trigger condition occurs.
 - 3.4. Select **Trigger logic** to activate the trigger automatically when two logically linked trigger conditions occur.
4. **Trigger condition tab:**

If you have selected **Simple trigger** or **Trigger logic**, define the **Source**, **Condition** and **Comparison** value for the trigger condition.

 - 4.1. If you have selected **Single trigger**, define the individual trigger condition.
 - 4.2. If you have selected **Trigger logic**, define both trigger conditions and the operator for the logical operation.

5. Channel assignment tab:
Select which data is to be recorded with the scope image.
 - 5.1. Parameter:
To record the value of a parameter, enter the coordinate, name and, if applicable, axis number of the parameter with the **Add parameter** dialog box via ... or by writing directly into the text field and using auto-completion (example: 1.I80 Current position).
 - 5.2. Signal name:
To record the value of a signal, select a signal for which you have assigned a signal name in the graphic programming.
 - 5.3. Physical address:
To record the value of a physical address in the drive controller memory, select the data type and specify the address.
6. Channel assignment tab, Sampling time selection:
Select the time interval at which the channel is to be sampled.
7. Channel assignment tab, Pre-trigger selection:
Define the percentage of the recording time before the trigger.
 - ⇒ The calculated recording time and pre-trigger time are displayed.
8. Confirm your settings with **Close**.

Creating a scope image

Start the scope image of the data in the drive controller and read out the scope image to DriveControlSuite according to the scope image and trigger settings.

- ✓ You are in the **Scope window**, **Scope images tab**.
- ✓ You have configured the settings for the scope image.
- ✓ There is an online connection between DriveControlSuite and the drive controller.

1. Action area:
To start the scope image of the data in the drive controller, click **Start**.
 - ⇒ The drive controller records the data in the scope memory in accordance with the scope image settings.
 - ⇒ The **Action area** of DriveControlSuite displays information about the status of the scope image.
 2. If you are using the **Manually at stop trigger** setting or if you want to stop the scope image early before the recording time expires, click **Stop**.
 - ⇒ When the trigger is triggered, DriveControlSuite reads the data from the scope memory according to the scope image settings.
- ⇒ The finished scope image is listed in the **Scope images tab** and can be opened via double-click.

20.2.2 Combining scope images

Combine scope images with each other to easily compare the recorded data.

- ✓ You are in the **Scope window**, **Scope images tab**.
 - ✓ You have created multiple scope images for a drive controller.
1. **Scope images tab:**
Select the scope images you want to combine and choose **Combine and open** from the context menu.
 - ⇒ **Combinations tab:**
The combined scope image is listed in the **Combinations tab** and opens in the image editor.

20.2.3 Creating a direct image

Create a scope image by specifying the scope image and trigger settings. Then start the scope image with an existing online connection.

Information

To create a scope image with the scope or multi-axis scope, you need an online connection between DriveControlSuite and the drive controller. You can establish the online connection either before or after defining the scope image and trigger settings.

Define the settings for scope images and triggers

Define the scope image settings and the trigger settings before you start the scope image.

1. Select the relevant drive controller in the project tree and click **Scope** in the project menu.
 - ⇒ The **Scope window** opens.
2. **Action area:**
To define the settings for the scope image, click **Settings**.
 - ⇒ The **Settings window** opens.
3. **Trigger condition tab:**
Define which event triggers the scope image.
 - 3.1. Select **Manual at stop** to activate the trigger via the **Stop button** (without pre-trigger).
 - 3.2. Select **Immediately at start** to activate the trigger via the **Start button** (with pre-trigger).
 - 3.3. Select **Simple trigger** to activate the trigger automatically when a trigger condition occurs.
 - 3.4. Select **Trigger logic** to activate the trigger automatically when two logically linked trigger conditions occur.
4. **Trigger condition tab:**
If you have selected **Simple trigger** or **Trigger logic**, define the **Source**, **Condition** and **Comparison value** for the trigger condition.
 - 4.1. If you have selected **Single trigger**, define the individual trigger condition.
 - 4.2. If you have selected **Trigger logic**, define both trigger conditions and the operator for the logical operation.

5. Channel assignment tab:
Select which data is to be recorded with the scope image.
 - 5.1. Parameter:
To record the value of a parameter, enter the coordinate, name and, if applicable, axis number of the parameter with the **Add parameter** dialog box via ... or by writing directly into the text field and using auto-completion (example: 1.I80 Current position).
 - 5.2. Signal name:
To record the value of a signal, select a signal for which you have assigned a signal name in the graphic programming.
 - 5.3. Physical address:
To record the value of a physical address in the drive controller memory, select the data type and specify the address.
6. Channel assignment tab, Sampling time selection:
Select the time interval at which the channel is to be sampled.
7. Channel assignment tab, Pre-trigger selection:
Define the percentage of the recording time before the trigger.
 - ⇒ The calculated recording time and pre-trigger time are displayed.
8. Confirm your settings with **Close**.

Creating a direct image

Start the scope image of the data in the drive controller and read out the scope image to DriveControlSuite according to the scope image and trigger settings.

- ✓ You are in the **Scope window**, **Direct image tab**.
- ✓ You have configured the settings for the scope image.
- ✓ There is an online connection between DriveControlSuite and the drive controller.

1. Action area:
To start the scope image of the data in the drive controller, click **Start**.
 - ⇒ The drive controller records the data in the scope memory in accordance with the scope image settings.
 - ⇒ The **Action area** of DriveControlSuite displays information about the status of the scope image.
 2. If you are using the **Manually at stop trigger** setting or if you want to stop the scope image early before the recording time expires, click **Stop**.
 - ⇒ When the trigger is triggered, DriveControlSuite reads the data from the scope memory according to the scope image settings.
- ⇒ The finished scope image is displayed in the **Direct image tab**.

20.3 Multi-axis scope images

Recording via multi-axis scope is divided into 3 steps:

- Preparation of the scope images in DriveControlSuite
 - Establish online connections
 - Select participating axes and define settings for triggering axes
 - Configure channels of the participating axes
 - Start recording
- Loading of the data in the drive controllers
 - Process of trigger communication (independent of DriveControlSuite)
 - Monitoring of individual recordings by DriveControlSuite
- Reading out and displaying the scope images
 - Read out scope images from the drive controllers
 - Display scope images in DriveControlSuite

20.3.1 Requirements

To find the participating drive controllers in the network and their communication with each other via broadcast, you must observe the following requirements:

- Network supports IPv4 limited broadcast
- All drive controllers are in the same subnet (broadcast domain)
- All drive controllers are connected with a switch via the X9 service interface
- Your PC with installed DriveControlSuite commissioning software is also connected with the switch
- Optional: EtherCAT-based controller takes over synchronization of the scope images via distributed clocks

The following graphic shows the basic network structure for multi-axis scope images.

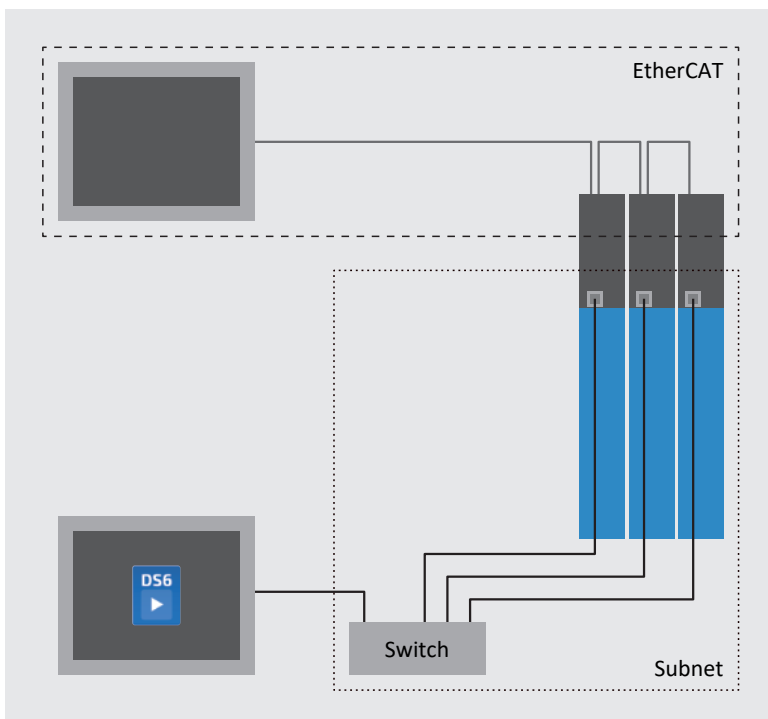

Fig. 73: Multi-axis scope: Network structure

20.3.2 Creating a multi-axis scope image

Create a scope image by specifying the scope image and trigger settings. Then start the scope image with an existing online connection.

Information

To create a scope image with the scope or multi-axis scope, you need an online connection between DriveControlSuite and the drive controller. You can establish the online connection either before or after defining the scope image and trigger settings.

Defining nodes and triggering axes

Define which axes are recorded for the multi-axis scope image and which of the axes can trigger the scope image.

1. Select the project in the project tree and click **Multi-axis scope** in the project menu.
 - ⇒ The **Multi-axis scope** window opens.
2. **Action area:**
To define the settings for the scope image, click **Settings**.
 - ⇒ The **Settings** window opens.
3. **Node and trigger condition tab, Node column:**
Activate all axes that you want to record with the multi-axis scope image.
4. **Node and trigger condition tab, Distribute trigger column:**
Activate all axes for which you want to define a trigger that triggers the scope image for all participating axes.
 - ⇒ The **Settings** button is displayed for each triggering axis.

Information

If you define more than one trigger for a multi-axis scope image, the scope image is triggered for all participating axes as soon as one of the trigger conditions occurs (logical OR operation).

Define the settings for scope images and triggers

Define the scope image settings and the trigger settings before you start the scope image.

✓ You are in the Multi-axis scope window > Settings window.

1. Node and trigger condition tab:

To define the trigger condition, click **Settings** next to the respective triggering axis.

⇒ The Settings window opens.

2. Node and trigger condition > Settings tab:

For each triggering axis, define which event triggers the scope image.

2.1. Select **Manual at stop** to activate the trigger via the **Stop** button (without pre-trigger).

2.2. Select **Immediately at start** to activate the trigger via the **Start** button (with pre-trigger).

2.3. Select **Simple trigger** to activate the trigger automatically when a trigger condition occurs.

2.4. Select **Trigger logic** to activate the trigger automatically when two logically linked trigger conditions occur.

3. Node and trigger condition > Settings tab:

If you have selected **Simple trigger** or **Trigger logic**, define the **Source**, **Condition** and **Comparison** value for the trigger condition.

3.1. If you have selected **Single trigger**, define the individual trigger condition.

3.2. If you have selected **Trigger logic**, define both trigger conditions and the operator for the logical operation.

4. Confirm your settings with **Close**.

⇒ The Settings window closes.

5. Node and trigger condition tab:

If you have defined more than one triggering axis, repeat the procedure for the remaining triggering axes.

6. Channel assignment tab:

Select which data is to be recorded with the scope image.

6.1. Parameter:

To record the value of a parameter, enter the coordinate, name and, if applicable, axis number of the parameter with the **Add parameter** dialog box via ... or by writing directly into the text field and using auto-completion (example: 1.I80 Current position).

6.2. Signal name:

To record the value of a signal, select a signal for which you have assigned a signal name in the graphic programming.

6.3. Physical address:

To record the value of a physical address in the drive controller memory, select the data type and specify the address.

7. Channel assignment tab, Sampling time selection:

Select the time interval at which the channel is to be sampled.

8. Channel assignment tab, Pre-trigger selection:

Define the percentage of the recording time before the trigger.

⇒ The calculated recording time and pre-trigger time are displayed.

9. Confirm your settings with **Close**.

Information

In a multi-axis scope image, you can define per channel whether the same data is recorded for all participating axes or individual data per axis. To do this, activate the **Individual** option in the **Channel assignment** tab, click **Open settings** and define the data to be recorded per participating axis for the respective channel.

Creating a multi-axis scope image

Start the scope image of the data in the drive controller and read out the scope image to DriveControlSuite according to the scope image and trigger settings.

- ✓ You are in the **Multi-axis scope** window.
 - ✓ You have configured the settings for the scope image.
 - ✓ There is an online connection between DriveControlSuite and the drive controller.
1. **Action area:**
To start the scope image of the data in the drive controller, click **Start**.
 - ⇒ The drive controller records the data in the scope memory in accordance with the scope image settings.
 - ⇒ The **Action area** of DriveControlSuite displays information about the status of the scope image.
 2. If you are using the **Manually at stop** trigger setting or if you want to stop the scope image early before the recording time expires, click **Stop**.
 - ⇒ When the trigger is triggered, DriveControlSuite reads the data from the scope memory according to the scope image settings.
- ⇒ The finished scope image is listed in the **Scope images** tab and can be opened via double-click.

20.4 Parameters

You can use the following parameters to configure additional settings for the scope images:

- T25 Automatic start
- T26 Retrigger scope

21 Replacement

The following chapters describe the replacement of a drive controller and the available accessories.

21.1 Notes on the safety configuration

A drive controller with extended safety technology through the SX6 safety module always requires a valid safety configuration. If this is missing, an error message is generated.

The checksums of the safety configuration are displayed in parameter S09 Safety modul checksum of safety configuration.

The safety configuration of the safety module has a unique CRC overall checksum in which the encrypted production number of the safety module (S09[1]), among other things, is saved. If different safety modules have an identical safety configuration, the checksums of the safety functions will match (S09[2]).

The safety configuration is saved on the safety module and, together with the configuration of the drive controller, in the internal configuration memory of the drive controller. If an SD card is available, a copy of the drive controller configuration is stored on the SD card when saving. S09[0] contains the checksum of the safety configuration from the current drive controller configuration.

Information

If you use drive controllers with extended safety technology through the SX6 safety module, use an SD card to transfer the configuration to the replacement drive controller in case of service.

21.2 Replacing the drive controller

WARNING!

Electrical voltage! Risk of fatal injury due to electric shock!

Hazardous voltages may be present on the connection terminals and the cores connected to them.

- Always switch off all power supply voltage before working on the devices!
- Note the discharge time of the DC link capacitors in the general technical data. You can only determine the absence of voltage after this time period.

ATTENTION!

Loss of absolute position!

The absolute position in the encoder is lost if the encoder cable is disconnected from the AES battery module.

- Do not disconnect the encoder cable from the AES during service work! Disconnect the AES from the drive controller.

Information

Note that the SD card from the drive controller being replaced can be re-used only for drive controllers of the same series.

Tools and material

You will need:

- Tool for loosening and tightening the fastening screws

Requirements and replacement

- ✓ Drive controllers of the same series and same power can be replaced interchangeably.
- ✓ The fieldbus variants of the firmware for the drive controller to be installed and to be replaced match.
- ✓ The hardware and firmware of the drive controller to be installed is of the same or a newer version as that of the drive controller to be replaced.
- ✓ The SD card is present in the drive controller being replaced; the original project is stored on the SD card. Or: The control unit of the drive controller being replaced still works; copy the original project to the SD card before removing the drive controller.

1. Optional: If an AES battery module is present, disconnect the AES from the drive controller.
 2. Disconnect all terminals from the drive controller being replaced.
 3. Release the grounding conductor from the ground bolt.
 4. Loosen the fastening screws and remove the drive controller from the control cabinet.
 5. Insert the SD card with the original project into the drive controller being installed.
 6. Optional: If you are using the SY6, SU6 or SX6 safety module, you must transfer its address in the FSoE or PROFIsafe network from the replaced drive controller to the new one (DIP switch S12) to be able to uniquely identify it in the network. For further information, refer to the manual for the corresponding safety module.
 7. Install the new drive controller in the control cabinet.
 8. Reconnect the previously removed grounding conductor.
 9. Reattach the terminals.
 10. Optional: If an AES battery module was present, attach it to the new drive controller with the associated encoder cable. Tighten the knurled screws so that AES is securely connected to the drive controller.
- ⇒ The replacement is completed. Now commission the new drive controller.

21.3 Commissioning the new drive controller after replacing the device

If the SD card with the original project is present and inserted, the data is loaded from the inserted SD card when the replacement drive controller is switched on. Now save the data in non-volatile memory on the drive controller. For drive controllers with extended safety technology through the SX6 safety module, deliberate action is required before saving in order to confirm the correct assignment of the safety configuration to the safety module.

Information

If available, the reference is also transferred to the replacement drive controller via the SD card. The information is also saved on the SD card if the action A00 Save values is executed for the referenced axis.

Drive controller without SX6 option (advanced safety technology)

- ✓ The SD card with the original project is inserted.
- 1. Switch on the 24 V_{DC} supply of the drive controller.
 - ⇒ The self-test of the drive controller starts.
 - ⇒ The green LED flashes with a single flash.
 - ⇒ The transfer of configuration data from the SD card starts.
 - ⇒ The green LED flashes steadily.
- 2. Press the S1 operating button for 3 s or carry out action A00, e.g., via DriveControlSuite.
 - ⇒ The green LED flashes quickly.
 - ⇒ All data is stored in non-volatile memory in the drive controller and on the SD card.
 - ⇒ The LEDs now switch back to the normal operating display.
- 3. Restart the drive controller to have the configuration on the drive controller take effect.
 - ⇒ The commissioning of the new drive controller is complete.

Drive controller with SX6 option (advanced safety technology)

- ✓ The SD card with the original project is inserted.
- 1. Switch on the 24 V_{DC} supply of the drive controller.
 - ⇒ The self-test of the drive controller starts.
 - ⇒ The green LED flashes with a single flash.
 - ⇒ The transfer of configuration data from the SD card starts.
 - ⇒ The red LED flashes with a double flash if the safety configuration needs to be activated.
- 2. Press and hold the S1 operating button within 30 s to activate the safety configuration.
 - ⇒ The red LED flashes with a double inverse flash.
 - ⇒ The safety configuration saved on the SD card is saved in the safety module.
 - ⇒ All LEDs flash with a triple flash.
 - ⇒ The safety configuration is activated.
 - ⇒ The green LED flashes with a double flash after successful activation.
- 3. Release the S1 operating button.
 - ⇒ The drive controller has a fault due to activation of the safety configuration (50: Safety module, cause 11).
 - ⇒ The red LED flashes with a single inverse flash.
- 4. Acknowledge the fault event.
 - ⇒ The LEDs switch back to the normal operating display.
- 5. Check whether the checksum of the safety functions stored in the machine documentation for the replaced drive controller matches the checksum of the new drive controller:
 - 5.1. Manual comparison: Check the checksum of the new drive controller in DriveControlSuite via parameter S09[2].
 - 5.2. Automated comparison: Monitor the checksum of the safety functions in the controller (S09[2]). If the checksum does not meet expectations, do not operate the machine.
- 6. Press the S1 operating button for 3 s.
 - ⇒ The green LED flashes quickly.
 - ⇒ All data is stored in non-volatile memory in the drive controller and on the SD card.
 - ⇒ The LEDs now switch back to the normal operating display.
- 7. Restart the drive controller to have the configuration on the drive controller take effect.
 - ⇒ The commissioning of the new drive controller is complete.

21.4 Replacing the SD card

STOBER recommends the use of cards with a storage capacity of 2 to 4 GB. The cards require FAT32 formatting (also refer to [X700: SD slot \[► 130\]](#)).

Preparation

To prepare the new, formatted card for operation in the drive controller, proceed as follows:

1. Switch on the 24 V_{DC} supply of the control unit.
2. Insert the formatted SD card.
3. Execute the action A00 and wait until saving is finished.

⇒ The preparation of the SD card is complete.

If an SD card is inserted when the drive controller is started, it is started from this card. Any existing configuration in the internal memory of the drive controller is ignored. If there is no configuration on the SD card or if it is invalid, the drive controller starts in emergency operation. For drive controllers with firmware V 6.5-A or higher, the fixed IP address 192.168.3.2 and fixed subnet mask 255.255.255.0 are used for service interface X9 in emergency operation.

In emergency operation, the internal configuration cannot be read out. If you require a data backup from the internal memory of the drive controller, you must save the information of the desired IP address, subnet mask and address assignment on the SD card (see [Starting a drive controller in emergency operation \[► 180\]](#)).

21.5 Updating firmware

The drive controllers are normally delivered with the latest firmware version. You can use the DriveControlSuite commissioning software to update the firmware version of one or more drive controllers simultaneously and then monitor the successful update. On the other hand, if a PC with a network connection is not available at the drive controller location, you also have the option of using an SD card to transfer a more current firmware version.

21.5.1 Updating firmware using DS6

If you require a different firmware version or want to update the firmware of a drive controller, you can change the firmware using the DriveControlSuite commissioning software. You can prepare a live firmware update while the drive controller and machine are operating. The update does not take effect until after a restart. This dual firmware behavior prevents a firmware loss or need for a case of service, since it ensures, for example, that the existing firmware can be accessed if the connection is interrupted.

Updating the firmware

Update the firmware of your drive controllers to the current version to use the full range of DriveControlSuite functions.

- ✓ You are in the Online functions window, Live firmware update tab.
- ✓ You have added a direct connection between DriveControlSuite and drive controllers.
- 1. Live firmware update tab:
 - Click Assign default version to all drive controllers.
 - ⇒ The current firmware version is assigned to the drive controllers.
 - 2. Click Start live firmware update.
 - 3. Confirm the safety note with OK.
 - ⇒ The firmware version is downloaded and installed during the next restart of the drive controller.
 - 4. For the live firmware update to take effect, click Restart all drive controllers.
 - 5. Confirm the restart with Yes.
 - ⇒ The fieldbus communication and connection between DriveControlSuite and drive controllers are interrupted.
 - ⇒ All connected drive controllers restart.

Information

The firmware version that is available for the update in the standard depends on the DriveControlSuite version used. Install the latest version of DriveControlSuite to update the firmware of your drive controllers to the latest version and to be able to use the full range of functions.

Updating firmware (alternative version)

To update the firmware of your drive controllers to a version other than that of the DriveControlSuite version used, proceed as described below.

- ✓ You are in the Online functions window, Live firmware update tab.
- ✓ You have added a direct connection between DriveControlSuite and the drive controller.
- 1. Live firmware update tab:
Click Add new firmware version.
 - ⇒ The Live firmware update dialog box opens.
- 2. Navigate to the firmware file (*.fli) that you want to use to perform the live firmware update.
- 3. Confirm with Open.
 - ⇒ The firmware version becomes available in the DriveControlSuite.
- 4. Assignment tab, Firmware update selection:
Select Alternative version.
- 5. Assignment area, Firmware version selection:
Select the firmware version you want to use to perform the live firmware update.
- 6. Click Start live firmware update.
- 7. Confirm the safety note with OK.
 - ⇒ The firmware version is downloaded and installed during the next restart of the drive controller.
- 8. For the live firmware update to take effect, click Restart all drive controllers.
- 9. Confirm the restart with Yes.
 - ⇒ The fieldbus communication and connection between DriveControlSuite and drive controllers are interrupted.
 - ⇒ All connected drive controllers restart.

21.5.2 Updating firmware using an SD card

If you would like to update the firmware of a drive controller but do not have access to a PC with a network connection, transfer the firmware version to the drive controller using an SD card.

Information

The fieldbus variant of the firmware (EC or PN) cannot be changed. The fieldbus variant of the firmware on the SD card must match the fieldbus variant of the drive controller firmware.

Preparation

Prepare an SD card with the latest firmware version. For information on the SD cards that can be used, see [X700: SD slot](#) [▶ 130].

- ✓ The firmware of the drive controller is at least version 6.4-A.
 - ✓ A more current version of DriveControlSuite is installed on your PC.
1. Create the `firmware` directory on the SD card.
 2. Use Windows Explorer to copy the `firmware.slf` file from the installation directory of DriveControlSuite (C:\Program Files (x86)\STOBER\DriveControlSuite\Suite) into the directory on the SD card.

Information

You can also transfer an older firmware version to drive controllers with firmware version 6.5-H or later.

Updating the firmware

Information

When a firmware file is being transferred by an SD card, the three LEDs flash in various combinations and frequencies. For information on this, see [Drive controller state](#) [▶ 246].

To update the firmware of the drive controller via SD card, proceed as described below.

- ✓ The prepared SD card is present.
1. Insert the prepared SD card into the drive controller.
 2. Start the drive controller.
 - ⇒ The transfer of the firmware file begins.
 - ⇒ The copying process is successfully completed as soon as the green LED of the drive controller flashes with a single flash.
 3. Remove the SD card when the transfer is complete.
 4. Since the firmware update only takes effect after the drive controller is restarted, restart the drive controller after completing the transfer.

21.6 Changing a fieldbus variant

Fieldbus communication is determined by the firmware. The SC6 drive controller is delivered with the firmware version in the required fieldbus variant. You can subsequently change the fieldbus using the DriveControlSuite commissioning software, provided that you are not using a fieldbus-specific safety module.

Information

You can only subsequently change the fieldbus for drive controllers with the SZ6 option (without safety technology) or SR6 option (STO using terminals).

For warranty reasons, when changing the fieldbus, you are prompted to notify our service department of the change with an email to replace@stoerber.de. The information relevant for this can be transferred directly from DriveControlSuite to your email program.

Information

Changing the fieldbus variant of the drive controller without contacting our Service department voids any warranty claims.

Changing a fieldbus variant

- ✓ You are in the Online functions window, Live firmware update tab.
- ✓ You have added a direct connection between DriveControlSuite and the drive controller.
- 1. Assignment area, Live firmware update selection:
Select Change fieldbus for the relevant drive controller.
 - ⇒ The Select and start fieldbus variant button is displayed below the picklist.
- 2. Click Select fieldbus variant and start.
- 3. Confirm the safety note with OK.
 - ⇒ The Select and start fieldbus window opens.
- 4. Select the desired fieldbus variant according to your firmware version.
- 5. To secure your warranty claim, inform STOBER Service about the change of fieldbus variant.
- 6. Activate the Email was sent option.
- 7. Click Start live firmware update.
 - ⇒ The firmware version is downloaded and installed during the next restart of the drive controller.
- 8. For the live firmware update to take effect, click Restart all drive controllers.
- 9. Confirm the restart with Yes.
 - ⇒ The fieldbus communication and connection between DriveControlSuite and drive controllers are interrupted.
 - ⇒ All connected drive controllers restart.

21.7 Motor replacement

When replacing a synchronous servo motor with EnDat encoder and electronic nameplate, the drive controller detects that a motor replacement has been performed upon switching on the drive controller (prerequisite: B04 = 64: Active).

As a response, the drive controller reads out the changed data from the electronic nameplate, transmits this data to the corresponding parameters and reports the process using a fault of type 81: Motor allocation. Based on the cause of the fault, you can recognize what has changed.

In order to take over the changed data onto the SD card and thus save it in non-volatile memory, you must carry out the action Save values in parameter A00.

Otherwise, the next time the drive controller is switched on, the electronic nameplate is read out again and the changed data is reported using a fault of type 81: Motor allocation.

22 Service

You can find important information all about our range of services in this chapter.

22.1 Information about the product

You can find information about your product online at the following address: <https://id.stober.com>.

In the search field there, enter the serial number, delivery note number or invoice number of the product.

Alternatively, you can use a suitable mobile device to scan in the QR code on the front of the device in order to directly access product information that is available online.

22.2 STOBER electronics service

If you need support, please contact our service department (see [Consultation, service and address \[▶ 408\]](#)).

Please have the following descriptive information on hand so that we can provide you with quick, professional assistance.

Ordering a replacement device

If you would like to order a replacement device, our System Support requires the following information:

- MV and serial number of the drive controller being replaced (see [Material variant \[▶ 30\]](#))
- Information on subsequent changes (e.g. change in option modules, application or firmware)

The MV number indicates the ordered and delivered material variant, i.e. the device-specific combination of all hardware and software components. The serial number is used to determine your customer information. Both numbers are stored in the STOBER enterprise resource planning system and make reordering a drive controller easier in case of service.

Service request

If you need assistance or have any questions regarding commissioning, create reverse documentation for your project as your first step. This makes it easier for our System Support to process your request.

22.3 Reverse documentation

If you have questions concerning commissioning and would like to contact our service department, start by first creating reverse documentation and send this to our System Support email address (see [Consultation, service and address \[▶ 408\]](#)).

When creating reverse documentation, DriveControlSuite captures a snapshot of the parameter values in the drive controller before the online connection is disconnected. With reverse documentation, the parameter values in DriveControlSuite, which you can otherwise only view with an existing online connection to the drive controller, are also available offline.

22.3.1 Creating reverse documentation

If you have any questions about commissioning your drive project and would like to contact our service department, create reverse documentation in advance so that we can help you more specifically.

Information

If you create reverse documentation of the values in the drive controller when disconnecting the online connection, the assigned configuration is write-protected in the project tree of DriveControlSuite until you delete the reverse documentation. The  icon in the project tree shows you whether a drive controller contains reverse documentation.

Creating reverse documentation (single)

- ✓ You are in the **Online functions window**, **Online tab**.
- ✓ There is an online connection between DriveControlSuite and drive controllers.
- 1. **Assignment area, drive controller:**
Click **Set offline** for the relevant drive controller.
 - ⇒ The **Reverse documentation dialog box** opens.
- 2. **Confirm the dialog box with Yes.**
 - ⇒ The reverse documentation is created and the drive controller is marked as write-protected in the project tree.
 - ⇒ The online connection between DriveControlSuite and the drive controller is disconnected.

Information

If you have networked multiple SD6 drive controllers via IGB motion bus, when you disconnect the connection, you can create reverse documentation for the entire module or selected drive controllers of the module by disconnecting the connection for the network adapter in the **Assignment area**.

Creating reverse documentation (all)

- ✓ You are in the **Online functions window**, **Online tab**.
- ✓ There is an online connection between DriveControlSuite and drive controllers.
- 1. **Online tab:**
Click **Set all drive controllers to offline (with reverse documentation)**.
 - ⇒ The reverse documentation is created, the drive controllers are marked in the project tree as write-protected.
 - ⇒ The online connections between DriveControlSuite and drive controllers are disconnected.

22.3.2 Deleting reverse documentation

Delete reverse documentation that you no longer need in order to remove the write protection of the drive controller in the project tree and be able to edit it again.

Information

If you create reverse documentation of the values in the drive controller when disconnecting the online connection, the assigned configuration is write-protected in the project tree of DriveControlSuite until you delete the reverse documentation. The  icon in the project tree shows you whether a drive controller contains reverse documentation.

Deleting reverse documentation

Clean reverse documentation that is no longer needed from your project.

- ✓ You have created one or more instances of reverse documentation.
- 1. Delete reverse documentation (drive controller):
Select the relevant drive controller in the project tree and choose **Delete reverse documentation** from its context menu.
- 2. Delete all reverse documentation (module):
Select the relevant module in the project tree and choose **Delete all reverse documentation** from its context menu.
- 3. Delete all reverse documentation (project):
Select the project in the project tree and choose **Delete all reverse documentation** from its context menu.
- ⇒ The reverse documentation of the selected drive controllers is deleted.
- ⇒ The write protection of the selected drive controllers is removed.

ATTENTION!

Data loss due to deletion

If you delete reverse documentation from the project, DriveControlSuite cannot restore the reverse documentation after the fact.

- Delete reverse documentation from the project only if you definitely no longer need it.

23 Appendix

23.1 Weights

Description	Type	ID No.	Weight without packaging [g]	Weight with packaging [g]
Double-axis controller sz. 0	SC6A062	56690	3600	5200
Double-axis controller sz. 1	SC6A162	56691	5300	6700
Single-axis controller sz. 2	SC6A261	56692	5200	6400
Terminal set for drive controller	All	Diverse	100	100
Quick DC-Link for drive controller sz. 0	DL6B10	56655	440	480
Quick DC-Link for drive controller size 1 or 2 (single-axis controller)	DL6B11	56656	560	600
Cover for Quick DC-Link DL6B10	QDL6C10	5050128	130	130
Cover for Quick DC-Link DL6B11	QDL6C11	5050129	190	190
Quick DC-Link insulation end section	—	56659	50	50
Option module without safety technology	SZ6	56660	50	50
Safety module – STO using terminals	SR6	56661	50	50
Safety module – STO and SS1 using PROFIsafe	SU6	56696	50	50
Safety module – STO and SS1 using FSoE	SY6	56662	50	50
Safety module – Extended safety technology using FSoE	SX6	5050185	50	50
EtherCAT cable approx. 0.25 m	—	49313	15	15
EtherCAT cable approx. 0.5 m	—	49314	20	20
PC connecting cable	—	49857	190	190
USB 2.0 Ethernet adapter	—	49940	50	50
Braking resistor	FZMU 400×65	49010	2200	2200
	FZZMU 400×65	53895	4170	4170
	GVADU 210×20	55441	300	300
	GBADU 265×30	55442	930	930
	GBADU 335×30	55443	1200	1200
Output choke	TEP3720-0ES41	53188	2900	2900
	TEP3820-0CS41	53189	5900	5900
	TEP4020-0RS41	53190	8800	8800
Battery module	AES	55452	60	60
HTL-to-TTL adapter	HT6	56665	30	30
Interface adapters	AP6A00	56498	30	30
	AP6A01	56522	30	30

Tab. 241: Weights of SC6 and accessories

23.2 Terminal specifications

Relevant information for project configuration of the connecting wiring can be taken from the following chapters.

EN 60204-1 contains basic recommendations that should be taken into account when selecting conductors. The chapter "Conductors and cables" provides specifications for the maximum current carrying capacity of conductors based on the way they are laid as well as tips for derating, for example in the case of increased surrounding temperatures or lines with multiple loaded individual conductors.

⚠ WARNING!

Personal injury and material damage due to electric shock and thermal overload!

- Prepare the conductor ends according to the terminal specifications.
- In the case of pre-made cables and conductors, check the conductor ends and adjust them if necessary.

23.2.1 Overview

The following tables clarify which specifications must be observed for which connections depending on the type of drive controller and accessory.

Drive controller

Type	X2A, X2B	X10	X11, X300	X20A, X20B	X21	X22	X101, X103
SC6A062	BCF 3,81 180 SN [▶ 353]	GFKC 2,5 -ST-7,62 [▶ 355]	BLDF 5.08 180 SN [▶ 353]	GFKC 2,5 -ST-7,62 [▶ 355]	GFKIC 2.5 -ST-7.62 [▶ 355]	ISPC 5 -STGCL-7,62 [▶ 356]	FMC 1,5 -ST-3,5 [▶ 354]
SC6A162		SPC 5		SPC 5	ISPC 5	ISPC 16	
SC6A261		-ST-7,62 [▶ 357]		-ST-7,62 [▶ 357]	-STGCL-7,62 [▶ 356]	-ST-10,16 [▶ 356]	

Tab. 242: Terminal specifications for the base device

Safety technology

Type	X12
SR6	BCF 3,81 180 SN [▶ 353]

Tab. 243: Terminal specifications of the safety technology

Braking resistors

Type	Braking resistor
FZMU, FZZMU	G 10/2 [▶ 354]

Tab. 244: Terminal specifications for the braking resistors

23.2.2 BCF 3,81 180 SN

Feature	Conductor type	Value
Contact spacing	—	3.81 mm
Nominal current at $\vartheta_{amb} = 40\text{ °C}$	—	CE/UL/CSA: 16 A/10 A/ 11 A
Max. conductor cross-section	Flexible without end sleeve	1.5 mm ²
	Flexible with end sleeve without plastic collar	1.0 mm ²
	Flexible with end sleeve with plastic collar	1.0 mm ²
	2 conductors, flexible, with double end sleeve with plastic collar	—
	AWG according to UL/CSA	16
Min. conductor cross-section	Flexible without end sleeve	0.14 mm ²
	Flexible with end sleeve without plastic collar	0.25 mm ²
	Flexible with end sleeve with plastic collar	0.25 mm ²
	2 conductors, flexible, with double end sleeve with plastic collar	—
	AWG according to UL/CSA	26
Insulation stripping length	—	10 mm
Tightening torque	—	—

Tab. 245: BCF 3,81 180 SN BK specification

23.2.3 BLDF 5.08 180 SN

Feature	Conductor type	Value
Contact spacing	—	5.08 mm
Nominal current at $\vartheta_{amb} = 40\text{ °C}$	—	CE/UL/CSA: 14 A/10 A/ 10 A
Max. conductor cross-section	Flexible without end sleeve	2.5 mm ²
	Flexible with end sleeve without plastic collar	2.5 mm ²
	Flexible with end sleeve with plastic collar	2.5 mm ²
	2 conductors, flexible, with double end sleeve with plastic collar	—
	AWG according to UL/CSA	12
Min. conductor cross-section	Flexible without end sleeve	0.2 mm ²
	Flexible with end sleeve without plastic collar	0.2 mm ²
	Flexible with end sleeve with plastic collar	0.25 mm ²
	2 conductors, flexible, with double end sleeve with plastic collar	—
	AWG according to UL/CSA	26
Insulation stripping length	—	10 mm
Tightening torque	—	—

Tab. 246: BLDF 5.08 180 SN specification

23.2.4 FMC 1,5 -ST-3,5

Feature	Conductor type	Value
Contact spacing	—	3.5 mm
Nominal current at $\vartheta_{amb} = 40\text{ °C}$	—	CE/UL/CSA: 8 A
Max. conductor cross-section	Flexible without end sleeve	1.5 mm ²
	Flexible with end sleeve without plastic collar	1.5 mm ²
	Flexible with end sleeve with plastic collar	0.75 mm ²
	2 conductors, flexible, with double end sleeve with plastic collar	—
	AWG according to UL/CSA	16
Min. conductor cross-section	Flexible without end sleeve	0.2 mm ²
	Flexible with end sleeve without plastic collar	0.25 mm ²
	Flexible with end sleeve with plastic collar	0.25 mm ²
	2 conductors, flexible, with double end sleeve with plastic collar	—
	AWG according to UL/CSA	24
Insulation stripping length	—	10 mm
Tightening torque	—	—

Tab. 247: FMC 1,5 -ST-3,5 specification

23.2.5 G 10/2

Feature	Conductor type	Value
Contact spacing	—	17.5 mm
Nominal current at $\vartheta_{amb} = 40\text{ °C}$	—	CE/UL/CSA: 57 A/65 A/ 65 A
Max. conductor cross-section	Flexible without end sleeve	10.0 mm ²
	Flexible with end sleeve without plastic collar	16.0 mm ²
	Flexible with end sleeve with plastic collar	16.0 mm ²
	2 conductors, flexible, with double end sleeve with plastic collar	6.0 mm ²
	AWG according to UL/CSA	6
Min. conductor cross-section	Flexible without end sleeve	0.5 mm ²
	Flexible with end sleeve without plastic collar	0.5 mm ²
	Flexible with end sleeve with plastic collar	0.5 mm ²
	2 conductors, flexible, with double end sleeve with plastic collar	0.5 mm ²
	AWG according to UL/CSA	24
Insulation stripping length	—	12 mm
Tightening torque	—	1.5 – 1.8 Nm

Tab. 248: G 10/2 specification

23.2.6 GFKC 2,5 -ST-7,62

Feature	Conductor type	Value
Contact spacing	—	7.62 mm
Nominal current at $\vartheta_{amb} = 40\text{ °C}$	—	CE/UL/CSA: 12 A/10 A/ 10 A
Max. conductor cross-section	Flexible without end sleeve	2.5 mm ²
	Flexible with end sleeve without plastic collar	2.5 mm ²
	Flexible with end sleeve with plastic collar	2.5 mm ²
	2 conductors, flexible, with double end sleeve with plastic collar	1.5 mm ²
	AWG according to UL/CSA	12
Min. conductor cross-section	Flexible without end sleeve	0.2 mm ²
	Flexible with end sleeve without plastic collar	0.25 mm ²
	Flexible with end sleeve with plastic collar	0.25 mm ²
	2 conductors, flexible, with double end sleeve with plastic collar	0.5 mm ²
	AWG according to UL/CSA	24
Insulation stripping length	—	10 mm
Tightening torque (for terminals with screw)	—	0.3 – 0.7 Nm

Tab. 249: GFKC 2,5 -ST-7,62 specification

23.2.7 GFKIC 2.5 -ST-7.62

Feature	Conductor type	Value
Contact spacing	—	7.62 mm
Nominal current at $\vartheta_{amb} = 40\text{ °C}$	—	CE/UL/CSA: 12 A/10 A/ 10 A
Max. conductor cross-section	Flexible without end sleeve	2.5 mm ²
	Flexible with end sleeve without plastic collar	2.5 mm ²
	Flexible with end sleeve with plastic collar	2.5 mm ²
	2 conductors, flexible, with double end sleeve with plastic collar	1.0 mm ²
	AWG according to UL/CSA	12
Min. conductor cross-section	Flexible without end sleeve	0.2 mm ²
	Flexible with end sleeve without plastic collar	0.25 mm ²
	Flexible with end sleeve with plastic collar	0.25 mm ²
	2 conductors, flexible, with double end sleeve with plastic collar	0.5 mm ²
	AWG according to UL/CSA	26
Insulation stripping length	—	10 mm
Tightening torque (for terminals with screw)	—	0.3 – 0.7 Nm

Tab. 250: Specification for GFKIC 2.5 -ST-7.62

23.2.8 ISPC 5 -STGCL-7,62

Feature	Conductor type	Value
Contact spacing	—	7.62 mm
Nominal current at $\vartheta_{amb} = 40\text{ °C}$	—	CE/UL/CSA: 32 A/35 A/ 35 A
Max. conductor cross-section	Flexible without end sleeve	6.0 mm ²
	Flexible with end sleeve without plastic collar	6.0 mm ²
	Flexible with end sleeve with plastic collar	4.0 mm ²
	2 conductors, flexible, with double end sleeve with plastic collar	1.5 mm ²
	AWG according to UL/CSA	8
Min. conductor cross-section	Flexible without end sleeve	0.2 mm ²
	Flexible with end sleeve without plastic collar	0.25 mm ²
	Flexible with end sleeve with plastic collar	0.25 mm ²
	2 conductors, flexible, with double end sleeve with plastic collar	0.25 mm ²
	AWG according to UL/CSA	24
Insulation stripping length	—	15 mm
Tightening torque	—	—

Tab. 251: ISPC 5 -STGCL-7,62 specification

23.2.9 ISPC 16 -ST-10,16

Feature	Conductor type	Value
Contact spacing	—	10.16 mm
Nominal current at $\vartheta_{amb} = 40\text{ °C}$	—	CE/UL/CSA: 55 A/66 A/ 66 A
Max. conductor cross-section	Flexible without end sleeve	16.0 mm ²
	Flexible with end sleeve without plastic collar	16.0 mm ²
	Flexible with end sleeve with plastic collar	10.0 mm ²
	2 conductors, flexible, with double end sleeve with plastic collar	4.0 mm ²
	AWG according to UL/CSA	4
Min. conductor cross-section	Flexible without end sleeve	0.75 mm ²
	Flexible with end sleeve without plastic collar	0.75 mm ²
	Flexible with end sleeve with plastic collar	0.75 mm ²
	2 conductors, flexible, with double end sleeve with plastic collar	0.75 mm ²
	AWG according to UL/CSA	20
Insulation stripping length	—	18 mm
Tightening torque	—	—

Tab. 252: SPC 16 -ST-10,16 specification

23.2.10 SPC 5 -ST-7,62

Feature	Conductor type	Value
Contact spacing	—	7.62 mm
Nominal current at $\vartheta_{amb} = 40\text{ °C}$	—	CE/UL/CSA: 32 A/35 A/ 35 A
Max. conductor cross-section	Flexible without end sleeve	6.0 mm ²
	Flexible with end sleeve without plastic collar	6.0 mm ²
	Flexible with end sleeve with plastic collar	4.0 mm ²
	2 conductors, flexible, with double end sleeve with plastic collar	1.5 mm ²
	AWG according to UL/CSA	8
Min. conductor cross-section	Flexible without end sleeve	0.2 mm ²
	Flexible with end sleeve without plastic collar	0.25 mm ²
	Flexible with end sleeve with plastic collar	0.25 mm ²
	2 conductors, flexible, with double end sleeve with plastic collar	0.25 mm ²
	AWG according to UL/CSA	24
Insulation stripping length	—	12 – 15 mm
Tightening torque (for terminals with screw)	—	0.3 – 0.7 Nm

Tab. 253: SPC 5 -ST-7,62 specification

23.3 Wiring examples

The following chapters show the basic connection using examples.

Information

For UL-compliant operation: The connections marked with PE are intended solely for the functional grounding.

23.3.1 Stand-alone operation with direct brake control

The following graphic shows a wiring example for the stand-alone operation of SC6 with direct brake control.

Note the information on EMC-compliant installation (see [EMC recommendations](#) [▶ 104]).

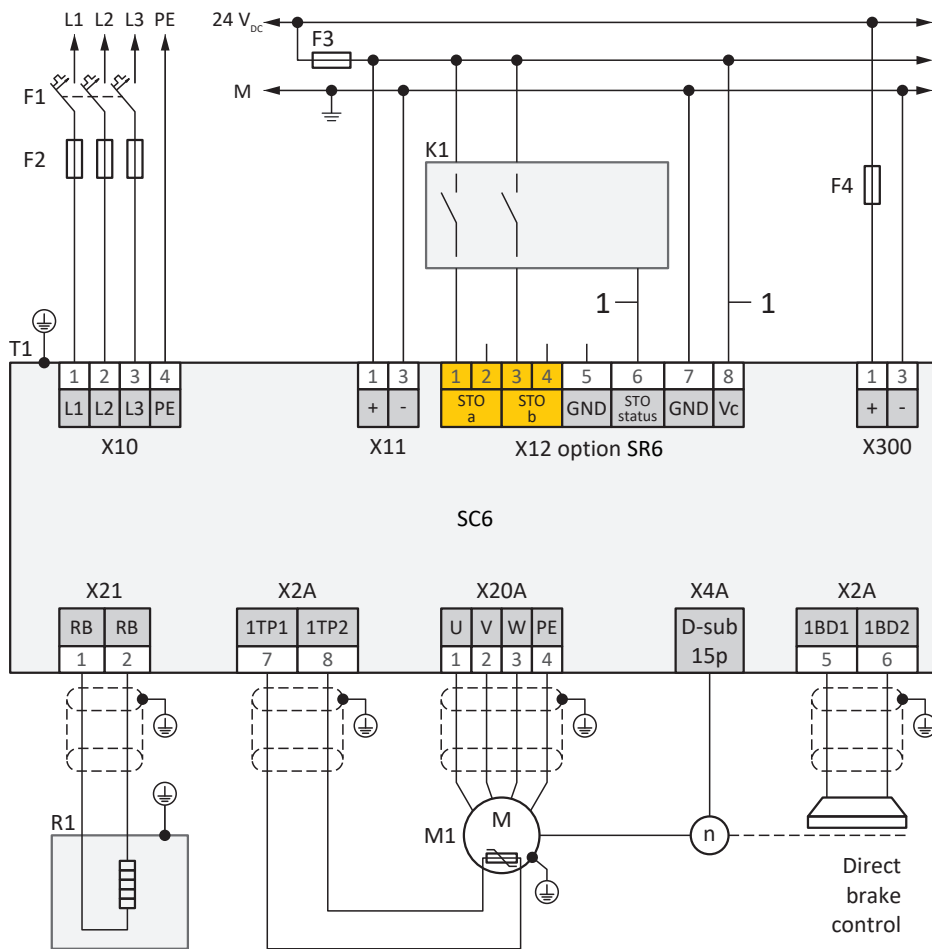

Fig. 74: Wiring example with direct brake control

- F1 – F4 Fuse
- K1 Safety relay
- L1 – L3 Three-phase power supply
- M Reference potential
- M1 Motor
- R1 Braking resistor
- T1 Drive controller
- 1 Optional connection

For UL-compliant operation:

The protective grounding of motors connected to the drive controller must not be connected using terminals X20A and X20B. The grounding conductor connection of the motor must be ensured for the respective application in accordance with the valid electrical standards.

23.3.2 DC link connection

The following graphic shows the basic connection of multiple SC6 drive controllers based on a DC link connection with Quick DC-Link DL6B.

Note the information on EMC-compliant installation (see [EMC recommendations](#) ▶ 104).

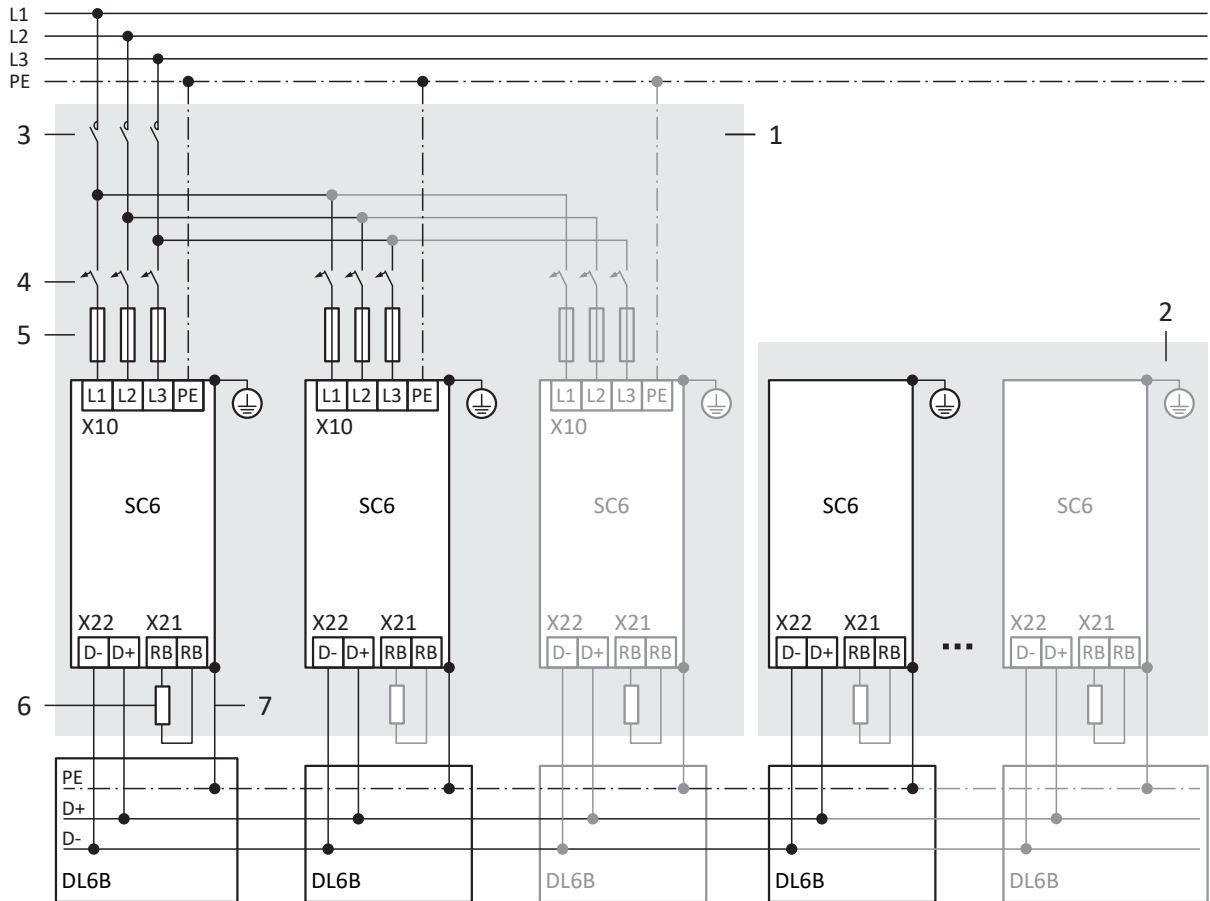

Fig. 75: Wiring example with Quick DC-Link

- 1 Group 1
- 2 Group 2
- 3 Contactor
- 4 Overload protection
- 5 Short-circuit protection
- 6 Braking resistor
- 7 Spring-loaded contact between DL6B and SC6

23.4 Order overview of the hardware components

Note that the drive controller is delivered without terminals. Suitable terminal sets are available separately for each size.

Information

The drive controller is delivered in the standard design without safety technology (option SZ6). If you want a drive controller with integrated safety technology, you must order it together with the drive controller. The safety modules are an integrated part of the drive controllers and must not be modified.

Drive controller		Safety technology	Terminal set	Quick DC-Link (optional)		
Type	ID No.	ID No.	ID No.	Type	ID No.	Width [mm]
SC6A062	56690	56660 ^{a)}	138652	DL6B10	56655	45
		56696 ^{b)}				
		56662 ^{c)}				
		5050185 ^{d)}				
		56661 ^{e)}	138680			
SC6A162	56691	56660 ^{a)}	138653	DL6B11	56656	65
		56696 ^{b)}				
		56662 ^{c)}				
		5050185 ^{d)}				
		56661 ^{e)}	138681			
SC6A261	56692	56660 ^{a)}	138654	DL6B11	56656	65
		56696 ^{b)}				
		56662 ^{c)}				
		5050185 ^{d)}				
		56661 ^{e)}	138682			

Tab. 254: Overview of hardware components with ID No.

- a) SZ6 option: Without safety technology
- b) SU6 safety module: STO and SS1 using PROFIsafe
- c) SY6 safety module: STO and SS1 using FSoE
- d) SX6 safety module: Extended safety technology using FSoE
- e) SR6 safety module: STO using terminals

Specify the desired fieldbus system (EtherCAT or PROFINET) when placing your order for the basic device in combination with option SZ6 or SR6, since fieldbus communication is defined by the firmware.

For each device group, an additional two insulation end sections are needed for the left and right termination of the Quick DC-Link modules (ID No. 56659, 2 pieces).

The quick fastening clamps for attaching the copper rails and an insulation connection piece are contained in the scope of delivery of the Quick DC-Link.

All delivered components (drive controllers and accessories) are marked to make it easy to assign connected components (e.g., assignment of a terminal set to the drive controller).

Copper rails

Each device group requires 3 copper rails (DC+, DC-, grounding). The copper rails (EATON CU12X5 034121 or Siemens 8WC5051) with a standard length of 1500 mm must be ordered from STOBER under the ID No. 56676.

For further accessories, see [Accessories](#) [▶ 33].

23.5 SSI encoders

The following chapters provide you with more detailed information on setting SSI encoders with the help of the DriveControlSuite commissioning software.

23.5.1 SSI: Evaluation at X4 with free setting (H00 = 78)

Obey the instructions described below if you use X4 as the connection for SSI encoders and want to use the free setting option for the encoder function.

Information

The free setting of SSI encoders is supported by drive controllers in firmware V 6.5-G or higher.

Evaluation of an encoder

To evaluate an encoder connected to X4, configure the following settings in DriveControlSuite.

Parameters	Description	Value		
		Rotational single-turn encoder	Rotational multi-turn encoder	Linear encoder
H00	Function	78: SSI free setting	78: SSI free setting	78: SSI free setting
H14	Data bit	Sum of single-turn bits + alarm bits	Sum of single-turn bits + multi-turn bits + alarm bits	Sum of position bits + alarm bits
H01	Mechanical value	1 rotation	1 rotation	Measuring range, e.g. 200 mm
H02	Raw encoder value	$2^{\text{Number of single-turn bits}}$	$2^{\text{Number of single-turn bits}}$	Number of increments of the measuring range

Tab. 255: Evaluation of an SSI encoder at X4 with free setting

Interpretation

The interpretation of the data bits as the position is carried out using the H01 and H02 parameters.

Relationship between resolution, clock frequency and double transmission in SSI encoders

Ideally, a new, valid position value in high resolution is available in every cycle of the control.

With a higher resolution of the position value, the amount of data to be transmitted (H14) increases and thus so does the transmission time. The same applies if the position is read out twice to enable better detection of transmission errors (H11) for increasing data security.

The transmission time of the position value should not exceed the cycle time of the control. To compensate for the increased transmission time, you can transmit the bits at a higher clock frequency (H15) if the SSI encoder supports this function. From approx. 600 kHz, cable lengths of 100 m are no longer possible.

23.5.2 SSI: Evaluation at X4 with fixed setting (H00 = 65)

Obey the instructions described below if you use X4 as the connection for SSI encoders and want to use the fixed setting option for the encoder function.

Information

For the setting of the data bit option (H10):

If none of the available data bit options matches the number or sum of bits of your encoder, use the nearest, larger data bit option. If the number or sum of bits of the encoder is greater than the largest available data bit option, then use the largest available data bit option.

Evaluation of an encoder

To evaluate an encoder connected to X4, configure the following settings in DriveControlSuite.

Parameters	Description	Value		
		Rotational single-turn encoder	Rotational multi-turn encoder	Linear encoder
H00	Function	65: SSI	65: SSI	65: SSI
H10	Data bit	Number of single-turn bits	Sum of single-turn bits + multi-turn bits	Number of position bits
H01	Mechanical value	1 rotation	1 rotation	Position bits ≤ Data bits: Distance per 1 LSB Position bits > Data bits: Distance per $2^{\text{Number of position bits} - \text{Number of data bits}}$ LSB
H02	Raw encoder value	$2^{\text{Number of data bits}}$	$2^{\text{Number of data bits} - \text{Number of multi-turn bits}}$	Position bits < Data bits: $2^{\text{Number of data bits} - \text{Number of position bits}}$ Position bits ≥ Data bits: 1

Tab. 256: Evaluation of an SSI encoder at X4 with fixed setting

Interpretation

The interpretation of the data bits as the position is carried out using the H01 and H02 parameters.

Relationship between resolution, clock frequency and double transmission in SSI encoders

Ideally, a new, valid position value in high resolution is available in every cycle of the control.

With a higher resolution of the position value, the amount of data to be transmitted (H10) increases and thus so does the transmission time. The same applies if the position is read out twice to enable better detection of transmission errors (H11) for increasing data security.

The transmission time of the position value should not exceed the cycle time of the control. To compensate for the increased transmission time, you can transmit the bits at a higher clock frequency (H06) if the SSI encoder supports this function and the cable length permits it.

Examples of rotary encoders

Number of single-turn bits	Number of multi-turn bits	Guide value H10	Guide value H01	Guide value H02
Up to 12	–	2: 13 bit short	1	$8192 = 2^{13}$
13	–	2: 13 bit short	1	$8192 = 2^{13}$
14 – 23	–	1: 24	1	$16\,777\,216 = 2^{24}$
24	–	1: 24	1	$16\,777\,216 = 2^{24}$
25	–	0: 25	1	$33\,554\,432 = 2^{25}$
Starting from 26	–	0: 25	1	$33\,554\,432 = 2^{25}$
12	12	1: 24	1	$4096 = 2^{24 - 12 = 12}$
13	12	0: 25	1	$8192 = 2^{25 - 12 = 13}$
14	12	0: 25	1	$8192 = 2^{25 - 12 = 13}$
13	13	0: 25	1	$4096 = 2^{25 - 13 = 12}$
13	14	0: 25	1	$2048 = 2^{25 - 14 = 11}$

Tab. 257: Examples of rotational SSI encoders at X4

Examples of translational encoders

Number of position bits	Guide value H10	Guide value H01	Guide value H02
12	2: 13 bit short	mm per 1 LSB	$2 = 2^{13 - 12 = 1}$
13	2: 13 bit short	mm per 1 LSB	1
14	1: 24	mm per 1 LSB	$1024 = 2^{24 - 14 = 10}$
15	1: 24	mm per 1 LSB	$512 = 2^{24 - 15 = 9}$
24	1: 24	mm per 1 LSB	1
25	0: 25	mm per 1 LSB	1
26	0: 25	mm per 2 LSB ($2^{26 - 25 = 1} = 2$)	1

Tab. 258: Examples of translational SSI encoders at X4

23.6 Commutation finding

Obey the instructions on commutation finding described below when using the control types 48: SSM-vector control incremental encoder or 70: SLM - vector control for synchronous servo motors or synchronous linear motors.

The following table provides an overview:

Control mode	Encoder	Commutation finding
48: SSM-vector control incremental encoder	Incremental encoders	Wake and Shake
70: SLM - vector control	Linear encoders (incremental encoders)	Wake and Shake
70: SLM - vector control	Linear encoders (absolute encoders)	Action B40

Tab. 259: Commutation finding with control mode B20 = 48 or 70

Commutation finding via Wake and Shake



Risk of fatal injury due to gravity-loaded vertical axis!

Gravity-loaded axes can sink during a commutation finding process using Wake and Shake because the brake for the commutation finding process has to be released.

- Use the 48: SSM-vector control incremental encoder and 70: SLM - vector control control modes in combination with a commutation finding process using Wake and Shake only for axes without a gravity load.
- For gravity-loaded axes, use motors with an absolute encoder.

Incremental encoders

With incremental encoders, commutation finding via Wake and Shake takes place automatically after the control unit is switched on and the power unit is enabled for the first time. Select the velocity control control type for this first enable (G90 = 2: Velocity control; alternatively: select a command with velocity control as the first motion command if G90 = 0: Inactive).

Incremental encoder in combination with a brake

With incremental encoders in combination with a brake, automatic commutation finding via Wake and Shake after Enable-on is not possible, as the brake is not released in this case (event 69: Motor connection, cause: 4: Brake).

Carry out the action B50 every time you switch on the control unit. The axis moves by up to one pole pitch during the action.

Commutation finding via action B40

Absolute encoder

With absolute encoders, start commutation finding via the action B40 Test phase with a referenced axis. Then execute the action A00 Save values.

23.7 Device addressing

MAC address

A MAC address consists of a fixed and a variable portion. The fixed portion designates the manufacturer and the variable portion distinguishes the individual network nodes and must be universally unique.

The MAC addresses of the interfaces are issued by STOBER and cannot be changed.

Information

The MAC address range of the STOBER hardware is: 00:11:39:00:00:00 – 00:11:39:FF:FF:FF

IP address – Value range

An IPv4 address always consists of 4 decimal numbers, each in a range from 0 to 255, and separated by periods. It must be unique within a (sub)network.

Subnet and subnet mask – Value range

Subnets are created in order to provide standalone networks with their own address range. Each IP address is divided into a network and host address. The subnet mask determines where this division takes place.

Like the IP address, the subnet mask consists of 4 decimal numbers, each in a range from 0 to 255, separated by periods.

Assignment for direct connection

In the default factory settings, both the IP address and the subnet mask are automatically assigned by DriveControlSuite or using DHCP for a direct connection. Alternatively, you can switch to manual parameterization using parameter A166.

The active address is displayed in parameter A157 and the active subnet mask in parameter A158.

Assignment for fieldbus connection

Note that the IP address and subnet mask are assigned by the controller for a fieldbus connection.

23.8 DriveControlSuite

The DriveControlSuite commissioning software uses wizards to guide you step by step through the installation process. You can find more detailed information on the system requirements and installation in the following chapters.

23.8.1 System requirements

The following minimum requirements for the PC system apply to the installation and operation of the DriveControlSuite commissioning software, including the integrated PASmotion Safety Configurator component, for configuring the SX6 safety module:

- Operating system: Windows 10 (32-bit, 64-bit *) or Windows 11 (32-bit, 64-bit *)
- Processor: Intel Pentium 4 (2 GHz, Dual Core) or equivalent
- Memory: 2 GB
- Free disk space on the hard disk: 1 GB
- Graphics: 1024 × 768 pixel resolution, 65536 colors
- Font size: 100% (default)
- Interfaces: 100 Mbps Ethernet (Fast Ethernet, copper)
- Display of documentation: Adobe Acrobat Reader version 7.1.0 or later**

*) Only DriveControlSuite

***) Only PASmotion Safety Configurator

23.8.2 Installation types

To install the DriveControlSuite commissioning software, select one of two installation types.

Default installation

Select this installation type if you want to install the latest version of DriveControlSuite. DriveControlSuite is installed in the version-independent .../Programs/STOBER/DriveControlSuite/ directory. During the installation process, you do not need to specify any additional installation instructions.

Provided that you are connected to the Internet, a check is performed prior to installation to determine if a newer software version is available. If a newer version is already available, it is downloaded and installed in place of the started version.

If an older software version is already installed on your PC, it is deleted prior to installation. However, if the latest version is already installed on your PC, a new installation is not performed.

User-defined installation

Select this installation type if you want to install a specific version of DriveControlSuite or if you still need an older version that is already installed on your PC. You can use this installation type to change the default installation directory and manage the version-dependent destination folders.

Checking whether the software version is up-to-date before installation is optional.

23.8.3 Installing DriveControlSuite

Current versions of the DriveControlSuite commissioning software can be found in our download center at: <http://www.stoeber.de/en/downloads/>.

Information

If you use the extended safety technology through the SX6 safety module, you also need the PASmotion Safety Configurator component integrated into DriveControlSuite. To this end, the PASmotion Safety Configurator installation wizard starts at the end of the DriveControlSuite installation process. You can either execute installation of the component for the safety configuration or cancel it if you do not need it.

- ✓ You have administrator rights.
 - ✓ The DriveControlSuite software is currently not running.
 - ✓ You have downloaded the setup file from the STOBER Download Center and saved it locally.
1. Start the installation via the setup file.
 2. Select the language for the installation and confirm with OK.
 3. Select Default as the installation type.
 - ⇒ If an Internet connection is available, the recency of the setup file is checked and, if necessary, the latest version is downloaded.
 - ⇒ The latest DriveControlSuite version is installed.
 - ⇒ After successful installation, DriveControlSuite checks the access to the network.
 - ⇒ If a firewall is active, a safety note opens according to the firewall settings.
 4. If applicable, allow DriveControlSuite to communicate on public and private networks.
 5. PASmotion Safety Configurator:
 - If you are using the SX6 safety module, follow the steps in the PASmotion Safety Configurator installation wizard.
- ⇒ After successful installation, DriveControlSuite opens automatically.

23.8.4 Communication requirements

Note the following requirements for the direct connection.

23.8.4.1 Personal firewall

For communication, both DriveControlSuite and the SATMISL communication service must be enabled in the PC's firewall.

Test communication is initiated during the installation of DriveControlSuite that opens a dialog box for enabling communication in case of an activated firewall. Note that operation on public networks must also be enabled for communication using mobile network adapters.

The required setup file for installing DriveControlSuite can be found in our download center at:

<http://www.stoerber.de/en/downloads/>.

Program/service	Path
DS6A.exe (DriveControlSuite)	Standard installation: C:\Program Files (x86)\STOBER\DriveControlSuite\bin Parallel installation of different versions (version 6.X-X): C:\Program Files (x86)\STOBER\DriveControlSuite (V 6.X-X)\bin
SATMISLVC.exe (SATMISL service)	32-bit Windows 7, 32-bit Windows 10, or 32-bit Windows 11: C:\Windows\System32 64-bit Windows 7, 64-bit Windows 10, or 64-bit Windows 11: C:\Windows\SysWOW64

Tab. 260: Programs and services

23.8.4.2 Protocols and ports for communication using routers

For communication using routers, the protocols and ports used by DriveControlSuite and the SATMISL communication service must be enabled in the routers, if applicable.

Protocol	Port	Use	Program/service
UDP/IP	37915	Connection test (inquiry)	SATMISL service
UDP/IP	37916	Node search	SATMISL service
UDP/IP	30001	Primary port for connection response (response)	SATMISL service
	30002 – 39999	Alternative ports for connection response (response)	
UDP/IP	40000	Primary port for IP address specification	DriveControlSuite
	40001 – 50000	Alternative ports for IP address specification	
TCP/IP	37915	Data transmission	DriveControlSuite

Tab. 261: Protocols and ports for a direct connection

23.8.5 Establishing a connection

Establishing an online connection between DriveControlSuite and the drive controller is divided into 3 steps. In each step, you can influence the settings for establishing the connection.

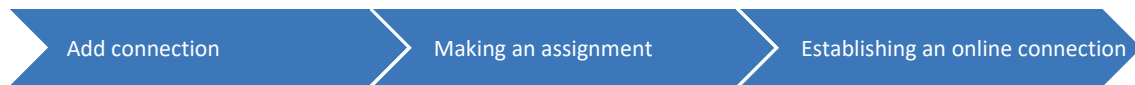

Fig. 76: DriveControlSuite: Establishing a connection

Add connection

To establish an online connection, first set up a **direct connection** between the drive controller and DS6 via the local network.

Making an assignment

After you have added the connection between DriveControlSuite and the drive controller and before you establish an online connection, make the assignment between the real drive controller and its virtual copy in the DS6. Select whether DriveControlSuite should have read or write access to the drive controller and assign a configuration from your project to each drive controller (manually or automatically).

- **Read access**
With read access, the configuration is read out from the drive controller to DriveControlSuite.
- **Send access**
With send access, the configuration is sent from DriveControlSuite to the drive controller.

Information

DriveControlSuite stores the reference and the production number of the real drive controller with which an online connection was last established in the project tree for each drive controller.

The information with which reference or with which production number an online connection most recently existed is saved as part of the project configuration. It is also retained when the drive controller is duplicated or imported into another project.

Establishing an online connection

After you have specified the settings for the assignment, the last step is to establish the online connection between DriveControlSuite and the drive controller. With an online connection, you can read out information from the drive controller to DriveControlSuite and vice versa. For example, the two-way data exchange allows you to create scope images for diagnostic purposes or to move axes using control panels. With an online connection, you can change the configuration with regard to the parameters. However, changes to the project configuration or graphical programming are only possible offline.

Information

Whether you have read or send access to the drive controller controls if the configuration is initially transferred from DriveControlSuite to the drive controller when the online connection is established or vice versa. As soon as there is an online connection, the information flows bidirectionally: The values of the drive controller are displayed in DriveControlSuite and changes in DriveControlSuite affect the drive controller.

23.8.5.1 Adding a connection (direct connection)

Add a direct connection to a drive controller in the local network to DriveControlSuite to enable an online connection to be established or to perform a firmware update. If the network topology does not allow an automatic direct connection, you can add a direct connection manually via the IP address of the drive controller.

Information

The **Add connection** dialog box can be reached via the start screen, the toolbar, the button in the project menu if you have selected the project or a module in the project tree, or via the button with the same name in the **Online functions** window.

Adding a direct connection

Establish a direct connection to a drive controller in the local network to enable an online connection to be established or to update the firmware.

- ✓ You are in the **Add connection** dialog box.
- ✓ The drive controller is switched on and can be found in the network.
- 1. **Direct connection** tab, **IP address** column:
Select the drive controller by activating the relevant IP address.
- 2. Confirm with **OK**.
- ⇒ The connection is added, the **Online functions** window opens.

Information

In the **Direct connection** tab, select **Select all** from the context menu to establish a direct connection to all drive controllers found in the local network.

Information

During the search, all drive controllers within the broadcast domain are found via IPv4 limited broadcast.

Requirements for finding a drive controller in the network:

- Network supports IPv4 limited broadcast
- All drive controllers and the PC are in the same subnet (broadcast domain)

Adding a direct connection (manual)

Establish a direct connection via the IP address of the drive controller if DriveControlSuite does not automatically find the drive controller in the local network due to the network topology.

- ✓ You are in the Add connection dialog box.
- ✓ The drive controller is switched on and can be found in the network.
- ✓ You know the IP address of the drive controller to which you want to establish a direct connection.

1. Direct connection (manual) tab, IP address field:
Enter the IP address of the drive controller (A157).

2. Confirm with OK.

⇒ The search for the specified IP address in the local network starts.

⇒ The connection is added, the Online functions window opens.

Information

DriveControlSuite cannot automatically find the drive controllers in the local network if they are connected to a controller, DS6 is running on a separate PC and the controller does not forward the broadcast telegrams of DS6 to the drive controllers. With the manual direct connection, DriveControlSuite deliberately sends unicast telegrams to the IP address of the respective drive controller. The telegrams are usually forwarded by the controller.

You can read out the IP address from the drive controller if an online connection exists, for example (parameter A157). For SD6 drive controllers, the IP address is shown on the display of the operating unit.

Adding a direct connection (additional IP addresses)

You can add additional IP addresses to the search in the local network if DriveControlSuite does not automatically find the drive controllers due to the network topology. The drive controllers found are displayed in the **Direct connection** tab and are available for establishing the connection.

- ✓ You are in the **Add connection** dialog box.
 - ✓ The drive controllers are switched on and can be found in the network.
 - ✓ You know the IP addresses of the drive controllers to which you want to establish a direct connection.
1. **Direct connection tab:**
Use the context menu to select **Additional IP addresses**.
⇒ The **Additional IP addresses** window opens.
 2. To include additional IP addresses in the local network search, select one of the options below.
 3. **Address range:**
To add additional IP addresses via an address range, activate the **Address range** option.
 - 3.1. **First IP address, Last IP address:**
Define the range of addresses you want to include in the local network search.
 4. **Address list:**
To add additional IP addresses via an address list, activate the **Address list** option.
 - 4.1. Define the list of IP addresses you want to include in the local network search, separated by commas.
 5. **Addresses from project:**
To add additional IP addresses in line with the project's presets, activate the **Addresses from project** option.
⇒ The IP addresses from the project's presets are included in the search in the local network.
 6. **Import settings:**
To import the settings for the search for additional IP addresses from an INI file (*.ini), click **Import**.
⇒ The **Import additional IP addresses** dialog box opens.
 - 6.1. Select the directory from which you want to import the settings.
 - 6.2. Confirm with **Open**.
⇒ The settings for searching for additional IP addresses are imported.
 7. To start the search for additional IP addresses in the local network according to the selected option, confirm with **OK**.
⇒ The search for the specified IP addresses in the local network starts.
⇒ The drive controllers found are displayed in the **Direct connection** tab and are available for establishing the connection.

Information

The list of additional IP addresses is not limited and there is no limit to the number of telegrams. An extensive address list can lead to increased telegram traffic and, accordingly, to increased network utilization.

23.8.5.2 Establishing an online connection

Establish an online connection between DriveControlSuite and the drive controller to read out or transfer a configuration, create scope images or use control panels to move the axis.

WARNING!

Injury to persons and material damage due to axis movement!

If there is an online connection between DriveControlSuite and the drive controller, changes to the configuration can lead to unexpected axis movements.

- Only change the configuration if you have visual contact with the axis.
- Make sure that no people or objects are within the travel range.
- For access via remote maintenance, there must be a communication link between you and a person on site with eye contact to the axis.

Adding a direct connection

Establish a direct connection to a drive controller in the local network to enable an online connection to be established or to update the firmware.

- ✓ You are in the **Add connection** dialog box.
 - ✓ The drive controller is switched on and can be found in the network.
1. **Direct connection** tab, **IP address** column:
Select the drive controller by activating the relevant IP address.
 2. Confirm with **OK**.
- ⇒ The connection is added, the **Online functions** window opens.

Information

In the **Direct connection** tab, select **Select all** from the context menu to establish a direct connection to all drive controllers found in the local network.

Information

During the search, all drive controllers within the broadcast domain are found via IPv4 limited broadcast.

Requirements for finding a drive controller in the network:

- Network supports IPv4 limited broadcast
- All drive controllers and the PC are in the same subnet (broadcast domain)

Establishing an online connection

Establish an online connection to enable the exchange of information between the drive controller and DriveControlSuite.

- ✓ You are in the Online functions window, Online tab.
 - ✓ The drive controller is switched on and can be found in the network.
 - ✓ You have added a direct connection between DriveControlSuite and the drive controller.
1. Assignment area, Access selection:
Select how DriveControlSuite should access the relevant drive controller.
 - 1.1. If DriveControlSuite is to read a configuration from the drive controller, select Read.
 - 1.2. If DriveControlSuite is to send a configuration to the drive controller, select Send.
 - 1.3. If DriveControlSuite is not to establish an online connection, select Do not connect.
 2. Assignment area, Configuration selection:
Select which configuration from the project tree is to be assigned to the real drive controller.
 - 2.1. Read access:
Select a configuration from the project tree or select Create new drive controller.
 - 2.2. Send access:
Select the configuration from the project tree that you want to send to the drive controller.
 3. Online tab:
Click Establish online connection.
 - ⇒ The online connection between DriveControlSuite and the drive controller is established.
 - ⇒ With read access, the configuration is read from the drive controller to DriveControlSuite.
 - ⇒ With send access, the configuration is sent from DriveControlSuite to the drive controller.

Information	
<p>For drive controllers with extended safety technology using the SX6 safety module, the PASmotion Safety Configurator configuration tool for transferring the safety configuration opens when an online connection is established (see also Transmitting the configuration [▶ 174]).</p>	

Information	
<p>Whether you have read or send access to the drive controller controls if the configuration is initially transferred from DriveControlSuite to the drive controller when the online connection is established or vice versa. As soon as there is an online connection, the information flows bidirectionally: The values of the drive controller are displayed in DriveControlSuite and changes in DriveControlSuite affect the drive controller.</p>	

Information	
<p>If you want to establish an online connection to multiple drive controllers, you can use the buttons in the Online tab to make the assignment easier by setting the access for all drive controllers to Read or Send.</p> <p>If you have previously established an online connection between DriveControlSuite and the drive controller with the current project, you can make the assignment automatically according to the reference or according to the production number of the drive controller.</p>	

23.8.6 Configuring virtual machines

If you would like to connect the drive controllers to the DriveControlSuite commissioning software from a virtual machine, you have to configure the communication between the virtual machine and host so that, from the perspective of the network, the virtual machine is no different from a physical PC.

VMware, Inc. VMware

If you use the VMware software from the company of the same name as a virtual machine, configure it in the VMware Workstation. For the direct connection, the virtual network card is operated as a network bridge.

Microsoft Windows Virtual PC

If you use the Windows Virtual PC software from Microsoft as a virtual machine, configure it in the Virtual PC software and in the Virtual Server. In both components, the name of the virtual network card has to match the physical network card. For Virtual PC network connections, Microsoft distinguishes between the **Public** and **Private** types. For the direct connection, the virtual network card is operated on the Virtual Server with the Public connection type.

Microsoft Hyper-V

If you use the Hyper-V software from Microsoft as a virtual machine, configure a Virtual Switch Manager in the Hyper-V Manager.

For network connections through Virtual Switch, Microsoft distinguishes between the **External**, **Internal** and **Private** types. For the direct connection, the virtual network card is operated with the External connection type.

Oracle VirtualBox

If you use the VirtualBox software from Oracle as a virtual machine, configure the network directly in VirtualBox. For the direct connection, a virtual network adapter is operated in bridge mode.

23.8.7 Updates

In the **Help** menu of the DriveControlSuite commissioning software, you can search for a newer version and, if available, download and install it.

Information

If the DriveControlSuite version is outdated, but the latest version is already installed on the computer, the check will yield the result that no newer version is available.

23.8.8 Script mode

Script mode is an automation function of the DriveControlSuite commissioning software. In Script mode, commands can be processed automatically. For example, this includes opening and closing project files or changing parameters. Processing commands can be used for executing various actions, such as transmitting a firmware update to multiple drive controllers.

When Script mode is called up from DriveControlSuite, a window with the same name opens. Here, you can transfer commands to DriveControlSuite in the form of a command script.

When you switch from Script mode to DriveControlSuite, the instance of DriveControlSuite being run in the background becomes visible.

Information

When using the SX6 safety module, the safety configuration is also transmitted to the drive controller using Script mode when a configuration is sent. After saving and restarting the drive controller, you must confirm the assignment of the safety configuration to the safety module with deliberate action, like you do in case of service (see [Commissioning the new drive controller after replacing the device](#) [▶ 340]).

23.8.8.1 Script mode window

In the DriveControlSuite – Script mode window, you can execute a command script and view information about the status of the script.

Information

The DriveControlSuite – Script mode window can be reached using the key combination [Ctrl] + [F9] when DriveControlSuite is open and by executing a command script by double-clicking the batch file when DriveControlSuite is closed.

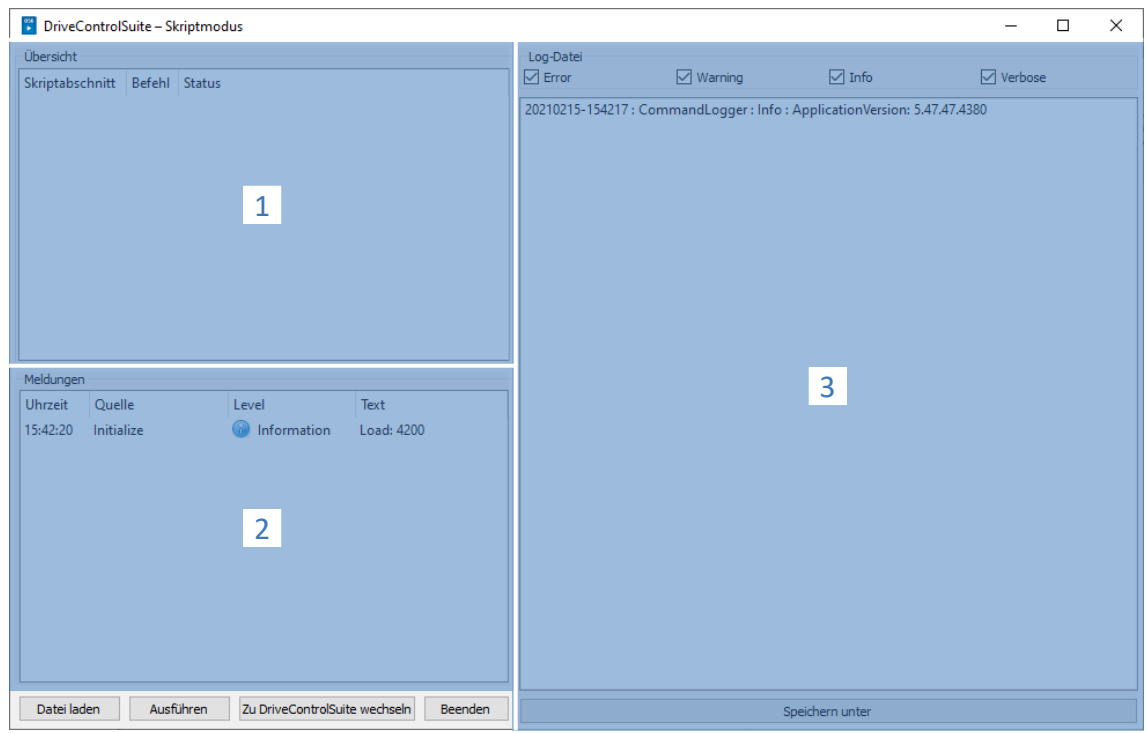

Fig. 77: Script mode: Program interface

No.	Area	Description
1	Overview	The Overview area informs you about the progress of the individual script sections.
2	Messages	The entries in the messages log the connection and communication status of the drive controllers, incorrect inputs caught by the system, errors when opening a project or rule violations in the graphical programming.
3	Log file	The Log file area shows the entries that are written to the log file while the command script is running. Each entry is output with a time stamp and source and can be filtered by its level through use of the options above the entries (Error, Warning, Info, Verbose). You can use Save as to save the log file locally.

Button	Description
Load file	Loads a command script in Script mode.
Run	Runs a loaded command script.
Switch to DriveControlSuite	Exits Script mode and switches to DriveControlSuite.
Exit	Exits Script mode and, where applicable, DriveControlSuite.

23.8.8.2 Command script structure

The command script is structured in the JSON data format (*.json) with UTF-8 encoding with BOM. You can find an introduction to JSON at:

<https://www.json.org/json-en.html>

Information

To create a script for DriveControlSuite, use a JSON editor such as JSON Editor Online, JSONViewer or Visual Studio Code.

Three data types are used in the script based on the standard JSON RFC-7159:

- Boolean
- String
- Integer

The command script is divided into three sections: settings, sequence and commands.

Script section	Description
settings	In the settings section, you define basic settings for executing the command script.
sequence	In the sequence section, you define the sequence of the individual commands.
commands	In the commands section, you define the individual commands of the command script.

23.8.8.2.1 "settings" script section

In the settings section, you define basic settings for executing the command script. You specify whether a log file is created when the script is executed and whether DriveControlSuite is closed after the script ends. The settings section is optional.

Attributes

- "logFilePath": Path of the log file, <optional> <string>
- "quitWhenDone": Behavior of DriveControlSuite after script end, <optional> <string>

Example

```
"settings": {
  "logFilePath": "%COMMANDFILE%/LoadNewConfig.log",
  "quitWhenDone": "never"
},
```

Creating a log file (logFilePath)

The log file logs the progress of a command script in chronological order. You create a log file by using the logFilePath attribute to specify the file path under which the log file is to be created. If you specify a file path for the log file, the command script will be executed only if the log file could be created successfully.

You can specify the file path for the log file either absolutely or relative to the command script directory (%COMMANDFILE%), \\ or / serve as separators of the path. By specifying %TIMESTAMP%, you can add the current time stamp (format: YYYYMMDD-hhmmss) to the file name and thus create a new log file each time the command script is executed. Without a time stamp in the file name, the log file will be overwritten each time the command script is executed.

Quit when done (quitWhenDone)

quitWhenDone can have three values assigned to it, which determine the behavior after the script is done.

"never"	DriveControlSuite remains open after the script has ended (default value).
"noErrors"	DriveControlSuite is closed after the script has ended, insofar as no errors have occurred.
"always"	DriveControlSuite is closed after the script has ended in every case.

23.8.8.2.2 "sequence" script section

In the sequence section, you define the sequence of the individual commands. The commands are specified as an array of strings with the key "sequence" and the name you specify in the commands section. A command can occur any number of times in the array.

The order in the array corresponds to the order in which the commands are executed in the command script. Set a reasonable order for the commands so that the command script does not abort with an error if a command cannot be executed. For example, you must first open a project (openProject) before you can change a parameter in it (setParameter).

Example

```
"sequence": [
  "commandName 1",
  "commandName 2",
  "commandName 1",
  "commandName 3"
],
```

23.8.8.2.3 "commands" script section

In the commands section, you define the individual commands of the command script. A command consists at least of a name and the "command" attribute, which determines the command and the further attributes of the command.

Example

```
"commandName1": {
  "command": "commandName",
  "attributeKey": "attributeValue"
},
```

23.8.8.3 Script mode commands

In the following, all available commands are described with the corresponding attributes.

The following table shows an overview of the available commands.

Command	Description
openProject [▶ 380]	Open project file
closeProject [▶ 380]	Close project file
connect [▶ 381]	Establish connection
disconnect [▶ 382]	Disconnect connection
setOnline [▶ 382]	Send/read out configuration
setOnlineByPreset [▶ 384]	Send/read out configuration according to the presets
setOffline [▶ 384]	Set offline
updateFirmware [▶ 385]	Multiple live firmware updates
setParameter [▶ 386]	Modify parameters
performAction [▶ 387]	Executing an action
openMessageBox [▶ 387]	Open message window
wait [▶ 388]	Wait
exportParameter [▶ 388]	Export parameters
importParameter [▶ 389]	Import parameters
updateTemplates [▶ 390]	Update project configuration
takeSnapShot [▶ 390]	Create reverse documentation
discardReverseDocumentation [▶ 391]	Delete reverse documentation

Tab. 262: Script mode commands

23.8.8.3.1 openProject

With the command `openProject`, you can open a project in Script mode, which is required for many commands. When you open a project with `openProject`, `closeProject` is automatically called for the current project.

Attributes

- `"filePath"`: directory of the project file (*.ds6), <binding> <string>

Description

In the `filePath` attribute, you specify the name of the project file to be opened. The specification can be made either as an absolute value or relative to the command script directory (`%COMMANDFILE%`).

Example

```
"openProjectfile": {
  "command": "openProject",
  "filePath": "<your path>"
},
```

23.8.8.3.2 closeProject

With the `closeProject` command, you can close an open project in Script mode. When you open a project with `openProject`, `closeProject` is automatically called for the current project.

Attributes

- `"saveAs"`: Storage directory of the project file (*.ds6), <optional> <string>
- `"saveBeforeClose"`: <optional> <Boolean>

Description

`saveAs` specifies the storage location of the project. Alternatively, the project can be saved at the path specified in the `filePath` attribute before it is closed with `saveBeforeClose: true`. By default, a dialog box opens if the project has been modified.

Example

```
"closeProjectfile": {
  "command": "closeProject",
  "saveBeforeClose": true
},
```

23.8.8.3.3 connect

With the connect command, you can establish a direct connection to the drive controllers of a module in Script mode.

Requirements for communication with the drive controllers include a direct connection to the drive controller and assignment to the module within the project under which this drive controller is recorded.

Attribute

- "module": Reference of the module in the project, <binding> <string>

One of the attributes listed below must be specified for the assignment. The IP address can always be used. The production number can be used only if the drive controller can be found by searching in a network. The reference can be used only if the drive controller can be found by searching in a network and a unique reference is defined for each drive controller that is found:

- "ipAddress": IPv4 address of the direct connection, <optional> <string>
- "serialNumber": Production number of the drive controller, <optional> <integer>
- "reference": Reference of the drive controller, <optional> <string>

Information

During the search, all drive controllers within the broadcast domain are found via IPv4 limited broadcast.

Requirements for finding a drive controller in the network:

- Network supports IPv4 limited broadcast
- All drive controllers and the PC are in the same subnet (broadcast domain)

Description

The command establishes a direct connection to the drive controller with the corresponding IP address, production number or reference.

Example

```
"ipConnect": {
  "command": "connect",
  "module": "M1",
  "ipAddress": "192.168.3.2"
},
"serialnumberConnect": {
  "command": "connect",
  "module": "M1",
  "serialNumber": 70012345
},
"referenceConnect": {
  "command": "connect",
  "module": "M1",
  "reference": "T123"
},
```

23.8.8.3.4 disconnect

With the disconnect command, you can disconnect all existing direct connections in Script mode (without reverse documentation).

Example

```
"DisconnectAll": {
  "command": "disconnect"
},
```

23.8.8.3.5 setOnline

With the setOnline command, you can establish an online connection in Script mode to send a configuration from the project to the drive controller or to read it from the drive controller into the project.

Attributes

- "direction": Read or send access; read or write, <optional> <string>
- "reference": Reference of the drive controller in the project, <optional> <string>
- "targetId": Reference, production number or IGB position of the physical drive controller, <optional> <string> or <integer>
- "targetType": igbPosition, serialNumber or reference, <optional> <string>
- "connectAndAssignMethod": serialNumber or reference, <optional> <string>

Description of single connection

The configuration of the active project file specified with "reference" is loaded into the specified drive controller or vice versa. The specification must be unique. Based on the content of targetType, a decision is made about how to interpret the content of targetId. The online connection is established in the reading or sending direction according to the attribute.

Value set of targetType:

1. "igbPosition": For position 0 (zero), the assignment is made using the most recently connected drive controller
2. "serialNumber": The assignment is made using the production number of the drive controller
3. "reference": The assignment is made based on the reference already existing in the drive controller (E120); this was assigned during the most recently executed project configuration

It is always a prerequisite that a drive controller with this igbPosition, production number or reference must be in the established connection.

Description of multi-connection

When using the connectAndAssignMethod attribute with the values serialNumber or reference (see example 4), the configurations of the active project file are loaded to the corresponding drive controllers most recently connected or vice versa. The online connection is established in the reading or sending direction according to the attribute.

Examples

Example 1

The configuration of the projected drive controller T1 is loaded into the device with the production number 7000026.

```
"sendConfigFromT1to7000026": {  
  "command": "setOnline",  
  "direction": "write",  
  "reference": "T1",  
  "targetId": 7000026,  
  "targetType": "serialNumber"  
},
```

Example 2

```
"readConfigOutOfIgb5intoT2": {  
  "command": "setOnline",  
  "direction": "read",  
  "reference": "T2",  
  "targetId": 5,  
  "targetType": "igbPosition"  
},
```

Example 3

```
"writeFromT3ToArAlt": {  
  "command": "setOnline",  
  "direction": "write",  
  "reference": "T3",  
  "targetId": "ArAlt",  
  "targetType": "reference"  
},
```

Example 4

```
"setOnline": {  
  "command": "setOnline",  
  "direction": "write",  
  "connectAndAssignMethod": "reference"  
},
```

23.8.8.3.6 Sending/reading out a configuration according to the presets (setOnlinebyPreset)

With the setOnlineByPreset command, you can establish an online connection in Script mode to send a configuration from the project to the drive controller or to read it from the drive controller into the project. The command uses the presets stored in the project to establish the connection. If you do not specify any specific drive controllers via the attributes, an online connection is established for all drive controllers in the project.

If you store presets for the connection setup in the project, you can easily store a command script or reuse it for multiple projects. For more information on the presets, see [Presetting connections](#) [▶ 393].

Attributes

- "module": Reference of the module, <optional> <string>
- "reference": Reference of the drive controller, <optional> <string>
- "direction": Read or send access; read or write; overwrites the preset transmission direction, <optional> <string>

Description

The transmission applies to one individual drive controller based on the specification of module and reference (see example 1), but it can also be defined for all drive controllers pre-defined in the project (see example 2).

Examples

Example 1

```
"singleConnectByPresets": {
  "command": "setOnlineByPreset", "module": "m1", "reference": "T1"
},
```

Example 2

```
"multiConnectByPresets": {
  "command": "setOnlineByPreset"
},
```

23.8.8.3.7 setOffline

With the setOffline command, you can disconnect the online connection to all connected drive controllers in Script mode (with or without reverse documentation). You can save changes to the parameter values of the drive controller before disconnecting.

Attribute

- "reverseDocumentation": For true or false, reverse documentation is either created or not, <optional> <Boolean> <default = false>
- "saveValues": For true, the parameter A00 is set to active before setOffline is carried out, <optional> <Boolean> <default = false>

Example

```
"setOfflineAndSaveValues":
{
  "command": "setOffline",
  "reverseDocumentation": false,
  "saveValues": true
},
```

23.8.8.3.8 Updating firmware (updateFirmware)

With the updateFirmware command, you can perform a live firmware update in Script mode for a defined list of drive controllers in the network.

Attributes

- "ipAddresses": List of IP addresses of the drive controllers at the gateways
- "serialNumbers": List of production numbers of the drive controllers at the gateways, <integer>
- "references": List of references of the drive controllers at the gateways
- "connectByMethod": serialNumber, reference or presets, <optional> <string>
 - "serialNumber": In the open project, all drive controllers are provided with a firmware update whose production number matches the production number defined in the project
 - "reference": In the open project, all drive controllers are provided with a firmware update whose references matches the reference defined in the project
 - "presets": In the open project, all drive controllers are provided with a firmware update that corresponds to the drive controllers defined in the presets
- "firmwarePath": Directory in which the firmware files are stored, <optional>
- "firmware": Firmware version
 - "default": In this value, the version of the target firmware corresponds to the DriveControlSuite version (highest firmware version that was loaded)
- "restart": Restart after the update is finished, <optional> <Boolean> <default = false>
- "waitForRenewedAvailability": Wait until the update has been completed and the drive controllers are available again in the network, <optional> <Boolean> <default = false>

Example

```
"updateFirmwareToV_6_4_D": {
  "command": "updateFirmware",
  "firmware": "V 6.4-D",
  "firmwarePath": "<your path>",
  "ipAddresses": ["192.168.3.101",
                 "192.168.3.102",
                 "192.168.3.103"
  ],
  "restart": true,
  "waitForRenewedAvailability": true
},
```

23.8.8.3.9 Changing the parameter value (setParameter)

With the setParameter command, you can change the value of a parameter in Script mode. You can execute the command both offline and with an existing online connection.

Attributes

- "module": Reference of the module, <binding> <string>
- "reference": Reference of the drive controller, <binding> <string>
- "coordinate": Coordinate of the parameter, <binding> <string>
- "value": Value of the parameter, <binding> <string>

Example

```
"setA10[3]:" {  
  "command": "setParameter",  
  "module": "M1",  
  "reference": "T2",  
  "coordinate": "A10[3]",  
  "value": "2"  
},
```

23.8.8.3.10 performAction

With the performAction command, you can perform an action in Script mode. You can only execute the command if there is an existing online connection.

Attributes

- "reference": Reference of the drive controller, <optional> <string>
 - If the specification is missing, the action is executed on all connected drive controllers
- "module": Reference of the module, <optional> <string>
 - If the specification is missing, the action is executed on all connected drive controllers
- "coordinate": Coordinate of the action parameter, <binding> <string>
- "waitForDone": Wait until the action has been completed, <optional> <Boolean> <default=true>
- "timeout", <optional> <integer><default = 60> (timeout in seconds):
 - If waitForDone is true: If the timeout is reached before the action has been fully completed, the command was unsuccessful and the sequence has been interrupted
 - If waitForDone is false: After the action is started, there is a wait until the timeout has expired; then the sequence is continued; the command is considered successfully processed
- "livingSpace": Axis (in the case of multiple axes, those to which a parameter is assigned), <optional> <string><default=Global>

Possible values:

```
"livingSpace": "Global",
"livingSpace": "Axis1",
"livingSpace": "Axis2",
"livingSpace": "Axis3",
"livingSpace": "Axis4",
```

Example

```
"restartSIAx1": {
  "command": "performAction",
  "module": "M1",
  "reference": "SIAx1",
  "coordinate": "A09",
  "livingSpace": "Global",
  "waitForDone": false,
  "timeout": 10
},
```

23.8.8.3.11 Opening a message (openMessageBox)

With the openMessageBox command, you can open a message in Script mode that displays the specified text. The command script is stopped until the message is confirmed with OK.

Attributes

- "text": text of the message, <binding> <string>

Example

```
"ShowMsgBox": {
  "command": "openMessageBox",
  "text": "Please press OK!"
},
```

23.8.8.3.12 wait

With the wait command, you can pause the command script in Script mode for the specified time.

Attribute

- "seconds": Wait time in seconds, <binding> <integer>

Example

```
"Wait15Secs": {
  "command": "wait",
  "seconds": 15
},
```

23.8.8.3.13 Exporting parameter values (exportParameter)

With the exportParameter command, you can export the parameter values of a drive controller, a module or the entire project in Script mode. If you do not define any specific drive controller or module via the attributes, the parameter values of the entire project are exported. You can work with the variables listed below to have unique file names when exporting the entire project. These are replaced by the actual values during export.

Attributes

- "exportPath": Directory to which the parameter values are exported as a text file, <binding> <string>
- "module": Reference of the module, <optional> <string>
- "reference": Reference of the drive controller, <optional> <string>

Variables

Variable	Description
%m%	Module reference
%M%	Designation of the module
%r%	Reference of the drive controller
%d%	Designation of the drive controller
%i%	Iteration over the number of drive controllers

Tab. 263: Script mode: Variables for importing and exporting parameters

Example

```
"ExportSingle": {
  "command": "exportParameter",
  "module": "M1",
  "reference": "T2",
  "exportPath": "%COMMANDFILE%/parameters_%r%-%d%_ProjectName.txt"
},
,
"ExportMulti": {
  "command": "exportParameter",
  "exportPath": "%COMMANDFILE%/parameters_%r%-%d%_ProjectName.txt"
},
,
```

23.8.8.3.14 Importing parameter values (importParameter)

With the `importParameter` command, you can import previously exported parameter values for a drive controller, a module or the entire project in Script mode. If you do not define a specific drive controller or module via the attributes, the parameter values of the entire project are imported. You can work with the variables listed below to have unique file names when exporting the entire project. These are replaced by the actual values during export.

Attributes

- `"importPath"`: Path to the text file from which the parameter values are imported, <binding> <string>
- `"module"`: Reference of the module, <optional> <string>
- `"reference"`: Reference of the drive controller, <optional> <string>
- `"deleteAfter"`: If true, the text file with the parameter values will be deleted after import <optional> <Boolean><default = true>
- `"reportPath"`: Path under which the change overview (*.html) is saved, <binding> <string>

Variables

Variable	Description
%m%	Module reference
%M%	Designation of the module
%r%	Reference of the drive controller
%d%	Designation of the drive controller
%i%	Iteration over the number of drive controllers

Tab. 264: Script mode: Variables for importing and exporting parameters

Example

```

"ImportSingle": {
  "command": "importParameter",
  "module": "M1",
  "reference": "T2",
  "importPath": "%COMMANDFILE%/parameters_%r%-%d%_ProjectName.txt",
  "reportPath": "%COMMANDFILE%/parameterImportReport_ ProjectName.html",
  "deleteAfter": false
},
,
"ImportMulti": {
  "command": "importParameter",
  "importPath": "%COMMANDFILE%/parameters_%r%-%d%_ProjectName.txt",
  "reportPath": "%COMMANDFILE%/parameterImportReport_ ProjectName.html",
  "deleteAfter": false
},
,

```

23.8.8.3.15 updateTemplates

With the updateTemplates command, you can update the project configuration of the drive controllers to the latest version in Script mode (templates and system parameter version).

Attributes

- "reportPath": Generates an overview (*.html) of the changes in the project configuration, <optional> <string>

Example

```
"updateTemplates": {
  "command": "updateTemplates",
  "reportPath": "%COMMANDFILE%/updateReport.html"
},
```

23.8.8.3.16 Creating reverse documentation (takeSnapshot)

With the takeSnapshot command, you can establish an online connection in Script mode to read out the configurations of the connected drive controllers into the project and to create reverse documentation when disconnecting. The configurations are read out into a new module in the project tree. If you do not use the attributes to specify any specific drive controllers, the configuration is read out for all drive controllers in the network and reverse documentation is created.

If no project is open, the command creates a new, empty project.

Attributes

- "ipAddresses": List of IP addresses of the drive controllers at the gateways, <optional> <string array>
- "serialNumbers": List of production numbers of the drive controllers at the gateways, <optional> <integer array>
- "references": List of references of the drive controllers at the gateways, <optional> <string array>

Information

During the search, all drive controllers within the broadcast domain are found via IPv4 limited broadcast.

Requirements for finding a drive controller in the network:

- Network supports IPv4 limited broadcast
- All drive controllers and the PC are in the same subnet (broadcast domain)

Description

The command establishes a direct connection to the gateway drive controllers with the corresponding IP addresses, production numbers or references.

Example 1

```
"takeSnapshot": {
  "command": "takeSnapshot"
},
```

Example 2

```
"takeSnapshotIpAddresses": {
  "command": "takeSnapshot",
  "ipAddresses": ["192.168.3.4", "192.168.3.139"]
},
```

Example 3

```
"takeSnapshotReferences": {
  "command": "takeSnapshot",
  "references": ["T3", "T4"]
},
```

Example 4

```
"takeSnapshotSerialNumbers": {
  "command": "takeSnapshot",
  "serialNumbers": [9011564, 9012296]
},
```

23.8.8.3.17 Deleting reverse documentation (discardReverseDocumentation)

With the discardReverseDocumentation command, you can delete one or all instances of reverse documentation in Script mode. If you do not define any specific drive controller via the attributes, the reverse documentation of all drive controllers in the project is deleted.

Attributes

- "reference": Reference of the drive controller, <optional> <string>
- "module": Reference of the module, <optional> <string>

Example

```
"discardReverseDocu": {
  "command": "discardReverseDocumentation",
  "reference": "T1"
  "module": "M1"
},
```

23.8.8.4 Executing a command script

To execute a command script, in addition to the actual script, you need a batch file with which you pass the command script to DriveControlSuite. You can execute the command script either when DriveControlSuite is opened from the DriveControlSuite – Script mode window or when DriveControlSuite is closed by double-clicking on the corresponding batch file.

Information

Place all the files you need to execute a command script in the same directory. To execute a command script, you need at least 2 files (command script and batch file). If you want to log the script execution, you also need a log file. Depending on the application, you may also need a project file if you want to create or import a backup, for example.

Information

For application examples for the Script mode, go to our download center at <http://www.stoerber.de/en/downloads/> and search for `Script mode`. The application examples contain sample files for the 3 following use cases: update firmware (firmware update), save configuration (backup) and import configuration (restore). You can adapt the sample files to your application by changing the number and addressing of the drive controllers and also the file names and path specifications.

Creating a command script

Create a command script (*.json) that contains the appropriate commands and attribute values for your application.

- ✓ You are in the directory for the command script files.
- 1. Create a new text file via the Windows Explorer context menu.
- 2. Assign a suitable file name and change the file extension from *.txt to *.json.
 - 2.1. Example: `FirmwareUpdate.json`.
- 3. Open the file.
- 4. Write the command script for your application by defining the settings, sequence and commands script sections.

4.1. Example:

```
{
  "settings": {
    "logFilePath": "%COMMANDFILE%/FirmwareUpdate.log",
    "quitWhenDone": "never"
  },
  "sequence": [
    "UpdateFirmware"
  ],
  "UpdateFirmware": {
    "command": "updateFirmware",
    "firmware": "V 6.4-D",
    "ipAddresses":
      [ "200.0.0.1",
        "200.0.0.2",
        "200.0.0.3"
      ],
    "restart": true
  }
}
```

- 5. Save the command script.

Creating a batch file

Create a batch file (*.bat) with which you pass the command script to DriveControlSuite.

- ✓ You are in the directory for the command script files.
- 1. Create a new text file via the Windows Explorer context menu.
- 2. Assign a suitable file name and change the file extension from *.txt to *.bat.
 - 2.1. Example: `FirmwareUpdate.bat`.
- 3. Open the file.
- 4. Specify the path to the EXE file of DriveControlSuite and assign the command script.

4.1. Example:

```
"C:\Program Files (x86)\STOBER\DriveControlSuite\bin\DS6A.exe"
FirmwareUpdate.json
```

- 5. Save the batch file.

Executing a command script

Execute a command script with DriveControlSuite closed or open.

- ✓ You are in DriveControlSuite.
- 1. Use the key combination [Ctrl] + [F9].
 - ⇒ The DriveControlSuite – Script mode window opens.
- 2. Click Load file.
 - ⇒ The Open file dialog box opens.
- 3. Navigate to the desired command script and click Open.
- 4. To run the command script, click Run.
 - ⇒ The command script will be executed.
 - ⇒ The DriveControlSuite – Script mode window displays information about the status of the command script in the Overview, Messages and Log file areas.

Information

You can execute a command script even when DriveControlSuite is closed by double-clicking the associated batch file. Double-clicking the batch file executes the command script and the DriveControlSuite – Script Mode window will open to display information about the status of the command script.

23.8.8.5 Presetting connections

You need the presets for the connection setup for the setOnlineByPreset command in Script mode. If you store presets for establishing the connection in the project, you can easily keep a command script or reuse it for multiple projects.

The IP addresses stored in the presets can be taken into account for establishing the connection when searching for drive controllers in the local network.

- ✓ You are in DriveControlSuite.
- ✓ Your project is open.
- 1. Select the project in the project tree and choose Preset connections from the context menu.
 - ⇒ The Preset connections window opens.
- 2. Direction selection:
Select whether read or send access to the drive controllers is to be made when the connection is established.
- 3. Target selection:
Select how the configuration and drive controller are to be assigned to each other when the connection is established (IP address, reference, production number, PLC device name).
- 4. Confirm the presets with OK.
 - ⇒ The presets are taken into account in the next execution of the setOnlineByPreset command.
 - ⇒ The stored IP addresses can be taken into account when searching for drive controllers in the local network.

23.8.8.6 Application examples for EtherCAT

Examples are provided to illustrate how Script mode functions and how you can use it.

The files required for running the application examples can be found in our download center at:

<http://www.stoerber.de/en/downloads/>.

Enter `Script mode` in the search field.

The package contains the example files for the following actions:

- Carry out a firmware update (FirmwareUpdate)
- Load the prepared configuration (Restore)
- Saving the current configuration (Backup)

The requirements for executing the actions are almost identical for all example files (see Running a script).

If you would like to use the example files, you must adapt them (file names and paths, addressing of the drive controllers).

Test setup

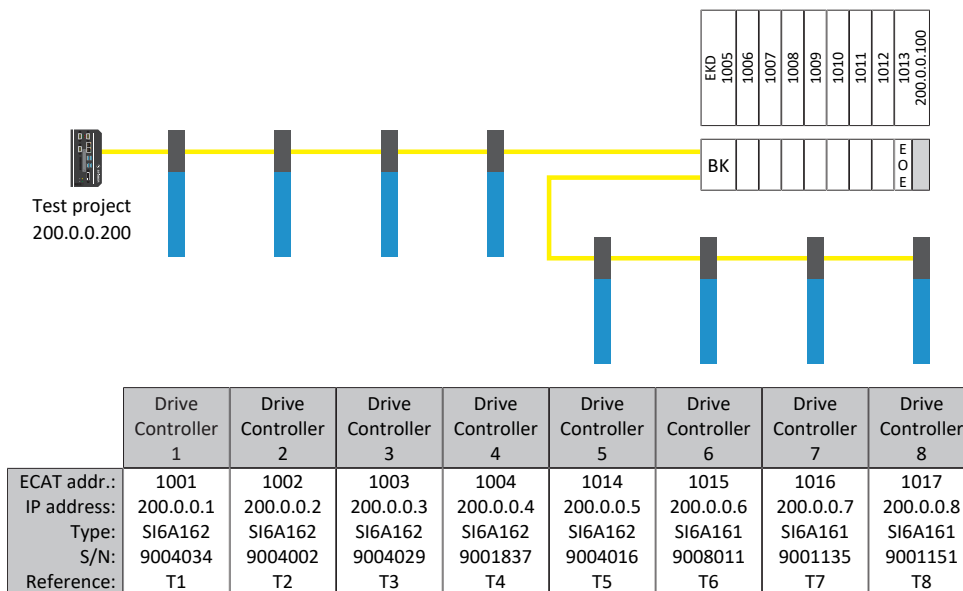

Fig. 78: Test setup of the application examples

Eight drive controllers of the SI6 series with fixed IP addresses 200.0.0.1 - 200.0.0.8 assigned by the EtherCAT MainDevice.

Variante 1

DriveControlSuite runs on the same IPC as the EtherCAT MainDevice.

Variante 2

The DriveControlSuite runs on a PC or laptop. The PC or laptop are on the same network as the IPC, but not on the same network as the EoE device group. A route must also be set here. For more information, see [Network route \[▶ 396\]](#).

23.8.8.6.1 Carrying out a firmware update

Requirements

- DriveControlSuite version 6.4-D or later is the default installation
- All drive controllers are operated with firmware version 6.4-A or later
- All drive controllers can be reached through a direct connection using IP addresses 200.0.0.1 to 200.0.0.8

Behavior of the script

The script for the drive controllers with the IP addresses 200.0.0.1 - 200.0.0.8 transfers a firmware update to firmware version 6.4-D. The drive controllers are then restarted.

Information

Be aware that values that have been changed or only stored in volatile memory are lost and that fieldbus communication and the connection to DriveControlSuite are interrupted in the event of a drive controller restart.

23.8.8.6.2 Load the prepared configuration (Restore)

Requirements

- DriveControlSuite version 6.4-D or later is the default installation
- All drive controllers are operated with firmware version 6.4-A or later
- All drive controllers can be reached through a direct connection using IP addresses 200.0.0.1 to 200.0.0.8
- A project file Restore.ds6 with the drive controllers

Behavior of the script

The configurations of the drive controllers projected in the Restore.ds6 project are transferred to the drive controllers with the parameterized IP addresses by a script.

Information

Be aware that values that have been changed or only stored in volatile memory are lost and that fieldbus communication and the connection to DriveControlSuite are interrupted in the event of a drive controller restart.

ATTENTION!

Machine damage from uncontrolled stopping!

Note that sending a configuration includes a brief stop of the device configuration. Communication with the EtherCAT MainDevice is interrupted. For this reason, the script may be run only in the pre-operational state.

23.8.8.6.3 Saving the current configuration (Backup)

Requirements

- DriveControlSuite version 6.4-D or later is the default installation
- All drive controllers are operated with firmware version 6.4-A or later
- All drive controllers can be reached through a direct connection using IP addresses 200.0.0.1 to 200.0.0.8
- A project file Backup.ds6 with the drive controllers.

Behavior of the script:

The configurations of the drive controllers with the parameterized IP addresses are saved in the Backup.ds6 file by a script.

23.8.8.6.4 Network route

The Internet Protocol (IP) ensures that data packets are communicated across network boundaries. Routing is the determination of a suitable path for transferring the data packets.

Particularly when EoE is used, it is often necessary to create a route manually.

Information

Note that manually routing to the controller will function only if the IP address of the controller and the IP address of the PC in question are in the same network. Otherwise, the network administration has to add a static route to the router's routing table.

Creating a network route

In Windows, the route is created as follows:

```
route ADD 200.0.0.0 MASK 255.0.0.0 192.168.12.36
```

Explanation:

200.0.0.0 is the EoE network with a network mask of 255.0.0.0.

192.168.12.36 is the address of the controller that connects to the EoE network.

Deleting a network route

In Windows, the route is deleted as follows:

```
route delete 200.0.0.0
```

23.8.8.7 Exit statuses

Calling a command script returns the exit statuses described below, which can be output on a Windows PC using the command prompt, for example. The exit status for the successful execution of a command script is 0. An exit status not equal to 0 signals an error.

Exit status	Name	Description or cause	Check and action
0	SUCCESS	Command script was executed without errors	—
100	JSON-ERROR	Error parsing the command script	Check syntax of JSON file and correct if necessary
101	JSON-FILE-NOT-EXISTING	Command script was not found	Check assignment of the command script in the batch file and correct if necessary
201	PROJECT-FILE-NOT-EXISTING	Project file was not found	Check attributes in the command script and correct if necessary
202	PROJECT-FILE-NOT-OPENING	Project file could not be opened	Check whether the DS6 project is already open and close it if necessary
203	PROJECT-FILE-NOT-READABLE	Project file was not readable	Check read access rights to the DS6 project and extend them if necessary
204	PROJECT-FILE-WRONG-FW	Project file could not be loaded due to wrong firmware; firmware version of the project file does not match the DriveControlSuite	Check firmware version in DS6 project and correct if necessary
210	CANNOT-SAVE-PROJECT-FILE	Project file could not be saved	Check write access rights to the DS6 project and extend them if necessary
300	CONNECTION-ERROR	Error when establishing a connection	Check network connection; check attributes in the command script and correct if necessary
400	SETONLINE-ERROR	Error during online connection if the error cannot be narrowed down more precisely	Check attributes in the command script and correct if necessary
401	SETONLINE-ERROR-READING	Error with read online connection	Check attributes in the command script and correct if necessary
402	SETONLINE-ERROR-WRITING	Error with write online connection	Check attributes in the command script and correct if necessary
500	FWUPDATE-ERROR	Error during firmware update if the error cannot be narrowed down more precisely	Check attributes in the command script and correct if necessary
501	FWUPDATE-FILE-NOT-FOUND	Error during firmware update if the firmware file was not found	Check attributes in the command script and correct if necessary
502	FWUPDATE-CONTROLLER-NOT-FOUND	Error during firmware update if the drive controller was not found	Check attributes in the command script and correct if necessary
601	PARAIMPORT-FILE-NOT-FOUND	Error during parameter import if the import file was not found	Check attributes in the command script and correct if necessary
602	PARAEXPORT-FILE-NOT-WRITABLE	Error during parameter export if the file could not be written	Check access rights to the directory and file and extend them if necessary
700	ACTION-ERROR	Error when performing an action if the error cannot be narrowed down more precisely	Check attributes in the command script and correct if necessary

Exit status	Name	Description or cause	Check and action
701	ACTION-WRONG-PARAMETER	Error while executing an action if the parameter coordinate was wrong	Check attributes in the command script and correct if necessary
800	SET-PARAMETER-ERROR	Error when writing a parameter value if the error cannot be narrowed down more precisely	Check attributes in the command script and correct if necessary
801	SET-PARAMETER-NOT-WRITABLE	Error when writing a parameter value if the parameter is write-protected	Parameter value cannot be changed; check attributes in the command script and change parameter coordinate if necessary
802	SET-PARAMETER-NOT-EXISTING	Error writing a parameter value if the parameter does not exist	Check attributes in the command script and correct if necessary
900	UPDATE-TEMPLATES-ERROR	Error when updating a template	Check project configuration of the drive controllers for compatibility with the latest version of the templates
1100	SNAPSHOT-ERROR	Error when creating reverse documentation	Check attributes in the command script and correct if necessary
1150	DISCARD-SNAPSHOT-ERROR	Error when deleting reverse documentation	Check attributes in the command script and correct if necessary
1200	ONLINE-BY-PRESET-ERROR	Error during online connection according to the default settings	Check network connection; check attributes in the command script and correct if necessary
1300	START-SAFETY-TOOL-ERROR	Error when starting PASmotion Safety Configurator	If necessary, reinstall DriveControlSuite with PASmotion Safety Configurator

Tab. 265: Script mode: Exit statuses

Extending a batch file

The exit status can be queried with the following command:

```
echo %ERRORLEVEL%
```

The following example shows the content of a batch file (*.bat), extended by the output of the exit status in the penultimate line:

```
echo off
"C:\Program Files (x86)\STOBER\DriveControlSuite\bin\DS6A.exe" FirmwareUpdate.json
IF %ERRORLEVEL% NEQ 0 Echo An error was found:
IF %ERRORLEVEL% EQU 0 Echo No error found:
echo %ERRORLEVEL%
pause
```

23.8.9 Simple Network Time Protocol (SNTP)

An SNTP client is implemented in the drive controller in accordance with RFC4330. This client sets the internal clock of the drive controller to the current time, which it obtains from an external time server. The internal clock runs with an (inaccurate) controllable internal clock in the drive controller. As a result, the time is queried from the server in intervals. It is compared with the internal time and the clock for the internal clock is readjusted accordingly. You define the settings in parameter A199.

Two NTP servers can be defined as time sources, both of which are used as possible time servers. In the case of data traffic via the service interface, the computer through which the drive controller is connected via DriveControlSuite automatically counts as one of the possible time servers. The time servers must be accessible either via EoE, service interface X9 or terminals X200 and X201. Make sure that the time server is accessible from the drive controller. It may be necessary to set the gateway parameter A175 accordingly.

The time is always requested from the same NTP server and then cyclically repeated by the server to track the synchronicity control loop. If the current server fails, the next one in the list is used. A server that was once active is discarded only in case of connection failure to this server or server unavailability.

After the drive controller is switched on, it takes a random time of 1 to 5 minutes (in accordance with RFC4330) until the SNTP client sends its first request to one of the time servers.

The cyclic repetition of a request occurs approximately every 5 to 6 hours.

23.8.9.1 Setting up time service on the computer

On a Windows PC with DriveControlSuite, you can use the registry editor to set up the time service. You must stop the time server in advance and restart it after changing the registry. Proceed as follows:

1. Open the command prompt, e.g. as follows:
 - 1.1. Use the [Windows]+[r] key combination to open the Run dialog box.
 - 1.2. Enter the command `cmd` and confirm with OK.
⇒ The command prompt opens.
2. Stop the time server by using the command `net stop w32time`.
3. Open the registry editor, e.g. as follows:
 - 3.1. Use the [Windows]+[r] key combination to open the Run dialog box.
 - 3.2. Enter the command `regedit` and confirm with OK.
⇒ The registry editor opens.
4. Select HKEY_LOCAL_MACHINE > SYSTEM > CurrentControlSet > Services > W32Time > TimeProvider > NtpServer.
5. Set `Enabled` to the value 1 and confirm with OK.
6. Close the registry editor.
7. Open the command prompt again.
8. Start the time server in the command prompt by using the command `net start w32time`.
⇒ The time service is set up on the PC.

Automation using a command script

If you want to change the registry on the PC via a command script, create a *.reg file by creating an empty text file and renaming the file extension. Then open the file and enter the following content:

```
[HKEY_LOCAL_MACHINE\SYSTEM\CurrentControlSet\Services\W32Time\TimeProviders\NtpServer] "Enabled"=dword:00000001
```

Run the file in the command line of the command prompt.

More commands

If you want to query the status on the current PC, use the following command in the command prompt:

```
w32tm /query /status
```

To query the IP address by PC name, use the following command at the command prompt:

```
nslookup <name>
```

Example:

```
nslookup ptbtime1.ptb.de
Name: ptbtime1.ptb.de
Addresses: 2001:638:610:be01::108 192.53.103.108
```

The IP address is: 192.53.103.108.

23.8.10 Security log

The Security log window shows a complete, antichronological overview of all changes to the firmware and configuration of the drive controller.

Information

In firmware V 6.5-K and later, the Security log window can be reached using either the context menu of the drive controller in the project tree or the button in the Online functions window.

In the Online functions window, the current security log is read out from the drive controller to DriveControlSuite if a direct connection or online connection exists. It can also be saved with the project file. In the project tree, the security log is only read out if there is an existing online connection. If there is no online connection between DS6 and the drive controller, the last security log read out is displayed.

Field	Description
Production number	Production number of the drive controller
Time stamp	Time stamp of the readout (local date and time)

Column	Description
Index	Entry index
Event type	Type of event
Date + time (UTC)	Date and time of the event in UTC (source: DS6)
Operating time	Operating time of the drive controller (source: E30)
Interface	Interface through which the event occurred (DriveControlSuite, SD card)
Event information	Information about the event

Information

The source for the Date + time (UTC) column of the event is the time that the drive controller has at the moment of the event (e.g. via DriveControlSuite or fieldbus). If the configuration of the drive controller is changed via the SD card, the date and time of the event are not recorded.

Button	Description
Export	Exports the security log to a CSV file (*.csv).
Close	Closes the Security log window.

23.8.10.1 Reading out the security log

With an existing online connection, you can read out the current version of the security log from the drive controller to DriveControlSuite in order to track changes to the firmware and configuration of the drive controller and export them if necessary.

Reading out the security log

Read out the security log from the drive controller into DriveControlSuite as described below.

- ✓ You are in the *Online functions* window.
- ✓ You have added a direct connection between DriveControlSuite and the drive controller.

1. Click next to the relevant drive controller on .
- ⇒ The security log is read out from the drive controller.
 - ⇒ The *Security log* window opens.

Exporting the security log

Export the security log to be able to view it later.

- ✓ You have read out the security log from the drive controller to DriveControlSuite.
- ✓ You are in the *Security log* window.

1. Click *Export*.
 - ⇒ The *Export security log* dialog box opens.
 2. Select the directory where you want to save the security log.
 3. Confirm with *Save*.
- ⇒ The security log is saved as a CSV file (*.csv).

23.9 Detailed information

The documentation listed below provides you with further relevant information on the 6th STOBER drive controller generation. The current status of the documentation can be found in our download center at:

<http://www.stoerber.de/en/downloads/>.

Enter the ID of the documentation in the search field.

The grouping of the documentation is intended to provide you with assistance, but is only relevant if you control the drive controller using a fieldbus.

PROFINET

Title	Documentation	Contents	ID
PROFINET communication – SC6, SI6	Manual	Electrical installation, data transfer, commissioning, diagnostics, detailed information	443039
PROFIdrive application – SC6, SI6	Manual	Project configuration, configuration, parameterization, function test, detailed information	443270
Drive Based application (DB) – SC6, SI6	Manual	Project configuration, configuration, parameterization, function test, detailed information	443437
Drive Based Synchronous application (DBS) – SC6, SI6	Manual	Project configuration, configuration, parameterization, function test, detailed information	443059
Drive Based Center Winder application (DBCW) – SC6, SI6	Manual	Project configuration, configuration, parameterization, function test, detailed information	443440
SU6 safety technology – STO and SS1 via PROFIsafe	Manual	Technical data, installation, commissioning, diagnostics, detailed information	443258
SR6 safety technology – STO via terminals	Manual	Technical data, installation, commissioning, diagnostics, detailed information	442741
Connection method	Manual	Selection of encoder, power and hybrid cables, accessories, technical data, connection	443102

EtherCAT

Title	Documentation	Contents	ID
EtherCAT communication – SC6, SI6	Manual	Electrical installation, data transfer, commissioning, diagnostics, detailed information	443025
CiA 402 application – SC6, SI6	Manual	Project planning, configuration, parameterization, function test, detailed information	443080
Drive Based application (DB) – SC6, SI6	Manual	Project configuration, configuration, parameterization, function test, detailed information	443437
Drive Based Synchronous application (DBS) – SC6, SI6	Manual	Project configuration, configuration, parameterization, function test, detailed information	443059
Drive Based Center Winder application (DBCW) – SC6, SI6	Manual	Project configuration, configuration, parameterization, function test, detailed information	443440
SX6 safety technology – Safe drive monitoring using FSoE	Manual	Technical data, installation, commissioning, diagnostics	443337
SY6 safety technology – STO and SS1 via FSoE	Manual	Technical data, installation, commissioning, diagnostics, detailed information	442744
SR6 safety technology – STO via terminals	Manual	Technical data, installation, commissioning, diagnostics, detailed information	442741
Connection method	Manual	Selection of encoder, power and hybrid cables, accessories, technical data, connection	443102

Additional information and sources that form the basis of this documentation or are referenced by the documentation:

EtherCAT Technology Group (ETG), 2015. *ETG.1300: EtherCAT Indicator and Labeling*. ETG.1300 S (R) V1.1.0. Specification. 2015-07-03.

23.10 Symbols in formulas

Symbol	Unit	Explanation
$C_{1\max}$	F	Maximum input capacitance
$C_{\max\text{PU}}$	F	Maximum charging capacity of the power unit
$C_{N,\text{PU}}$	F	Nominal charging capacity of the power unit
C_{PU}	F	Self-capacitance of the power unit
D_{IA}	%	Reduction in the nominal current depending on the installation altitude
D_T	%	Reduction in the nominal current depending on the surrounding temperature
$E_{2\max}$	J	Maximum switch-off energy at the output
η_N	%	Nominal efficiency
$f_{1\max}$	Hz	Maximum input frequency
$f_{2\max}$	Hz	Maximum output frequency
$f_{2\text{PU}}$	Hz	Output frequency of the power unit
f_N	Hz	Rotating magnetic field frequency at nominal speed
$f_{\text{PWM,PU}}$	Hz	Frequency of the pulse width modulation of the power unit
I_0	A	Stall current
$I_{1\max}$	A	Maximum input current
$I_{1\max\text{CU}}$	A	Maximum input current of the control unit
$I_{1N,\text{PU}}$	A	Nominal input current of the power unit
$I_{2\max}$	A	Maximum output current
$I_{2\max\text{PU}}$	%	Maximum output current of the power unit (in relation to the nominal output current)
$I_{2N,\text{PU}}$	A	Nominal output current of the power unit
$I_{2\text{PU(A)}}$	A	Output current of the power unit for axis A
$I_{2\text{PU(B)}}$	A	Output current of the power unit for axis B
i^2t	%	Limit load integral
$I_{d,\text{ref}}$	A	Magnetization-generating reference current in the d/q coordinate system
I_{LINE}	A	Supply current
$I_{\max\text{LINE}}$	A	Maximum supply current
$I_{\min\text{LINE}}$	A	Required supply current
I_N	A	Nominal current
$I_{N,\text{MF}}$	A	Nominal current of the choke or motor filter
$I_{q,\text{ref}}$	A	Torque/force-generating reference current in the d/q coordinate system
K_I	—	Integral coefficient
K_P	—	Proportional coefficient
λ_{LINE}	—	Power factor of the supply grid
M/F_{set}	Nm/N	Set torque or set force
M_0	Nm	Stall torque
$M_{1\text{Bstat}}$	Nm	Static braking torque of the brake in the motor adapter (tolerance +40%, -20%)
M_{2N}	Nm	Nominal torque on the gear unit output (relative to n_{1N})
$M_{2\text{NOT}}$	Nm	Gear unit emergency off torque on the gear unit output for max. 1000 load changes
M_B	Nm	Braking torque
M_{Bstat}	Nm	Static braking torque of the motor brake at 100 °C

Symbol	Unit	Explanation
M_k	Nm	Permitted tilting torque on the output
M_N	Nm	Nominal torque
$M_{N,B}$	Nm	Nominal braking torque
n_{1N}	rpm	Nominal speed at the gear unit input
n_{2N}	min ⁻¹	Nominal speed at the gear unit output
n_{fed}	–	Number of drive controllers connected to the grid
n_N	rpm	Nominal speed: The speed for which the nominal torque M_N is specified
p	–	Number of pole pairs
P_{effRB}	W	Effective power at the external braking resistor
P_{LINE}	W	Power output
P_{maxRB}	W	Maximum power at the external braking resistor
P_{MOT}	W	Motor rating
$P_{totalMOT}$	W	Total rating of all motors
P_V	W	Power loss
$P_{V,CU}$	W	Power loss of the control unit
R_{2minRB}	Ω	Minimum resistance of the external braking resistor
ϑ_{amb}	°C	Surrounding temperature
$\vartheta_{amb,max}$	°C	Maximum surrounding temperature
t_{1B}	ms	Engaging time (also: linking time) of the brake; time span from when the current is switched off until the nominal holding torque is reached
t_{2B}	ms	Release time (also: disengagement time) of the brake; time span from when the current is switched off until the brake is completely released
T_M	Year, a	Mission time
T_i	ms	Reset time
t_{min}	ms	Minimum cycle time of the application
τ_{th}	°C	Thermal time constant
U_0/U	V	Nominal voltage of electrical conductors, expressed by the ratio of 2 values: <ul style="list-style-type: none"> ▪ U_0: RMS value of the voltage between the line conductor and ground ▪ U: RMS value of the voltage between 2 line conductors
U_1	V	Input voltage
U_{1CU}	V	Input voltage of the control unit
U_{1max}	V	Maximum input voltage
U_{1PU}	V	Input voltage of the power unit
U_2	V	Output voltage
U_{2PU}	V	Output voltage of the power unit
$U_{2PU,ZK}$	V	Output voltage of the power unit for the DC link connection (typical values: 400 V _{AC} corresponds to 560 V _{DC} , 480 V _{AC} corresponds to 680 V _{DC})
U_{max}	V	Maximum voltage
U_{maxMOT}	V	Maximum motor voltage
U_{MOT}	V	Motor voltage
U_{offCH}	V	Switch-off threshold of the brake chopper
U_{onCH}	V	On limit of the brake chopper

Symbol	Unit	Explanation
v_{act}	m/min	Actual velocity
v_{set}	m/min	Set velocity
x_{act}	m	Actual position
x_{set}	m	Set position

23.11 Abbreviations

Abbreviation	Meaning
AC	Alternating Current
AEH	Aderendhülse (end sleeve)
AWG	American Wire Gauge
BAT	Battery
BG	Baugröße (size)
CiA	CAN in Automation
CNC	Computerized Numerical Control
CSA	Canadian Standards Association
csp	Cyclic synchronous position mode
cst	Cyclic synchronous torque mode
csv	Cyclic synchronous velocity mode
DC	Direct Current
DHCP	Dynamic Host Configuration Protocol
DI	Digital Input
DMZ	Demilitarized zone
EMC	Electromagnetic Compatibility
ETG	EtherCAT Technology Group
EtherCAT	Ethernet for Control Automation Technology
FAT	File Allocation Table
FSoE	Fail Safe over EtherCAT
HTL	High Threshold Logic
IE	International Efficiency
IE class	Energy efficiency class
IIoT	Industrial Internet of Things
ip	Interpolated position mode
IP	International Protection
IP	Internet Protocol
MDevice	MainDevice
NAT	Nennansprechtemperatur (nominal response temperature)
NTP	Network Time Protocol
P controller	Proportional controller
PE	Protective Earth (grounding conductor)
PELV	Protective Extra Low Voltage

Abbreviation	Meaning
PI controller	Proportional-Integral controller
PID controller	Proportional-Integral-Differential controller
PL	Performance Level
pp	Profile position mode
PRM	Predictive Maintenance
pt	Profile torque mode
PTC	Positive Temperature Coefficient
pv	Profile velocity mode
RCD	Residual Current protective Device
RCM	Residual Current Monitoring device
RFC	Request For Comments
RoHS	Restriction of Hazardous Substances
SCCR	Short-circuit current rating
SD	Secure Digital (memory card)
SDHC	Secure Digital High Capacity (memory card)
S/FTP	Screened/Foiled Twisted Pair
SF/FTP	Screened Foiled/Foiled Twisted Pair
SF/UTP	Screened Foiled/Unshielded Twisted Pair
SIL	Safety Integrity Level
SNTP	Simple Network Time Protocol
PLC	Programmable Logic Controller
SS1	Safe Stop 1
SSI	Serial Synchronous Interface
STO	Safe Torque Off
SubDevice	SubordinateDevice
TCP	Transmission Control Protocol
TTL	Transistor-Transistor Logic
UL	Underwriters Laboratories
W&S	Wake and Shake

24 Contact

24.1 Consultation, service and address

We would be happy to help you!

We offer a wealth of information and services to go with our products on our website:

<http://www.stoeber.de/en/service>

For additional or personalized information, contact our consultation and support service:

<http://www.stoeber.de/en/support>

If you need our system support:

Phone +49 7231 582-3060

systemsupport@stoeber.de

If you need a replacement device:

Phone +49 7231 582-1128

replace@stoeber.de

Call our 24-hour service hotline:

Tel. +49 7231 582-3000

Our address:

STÖBER Antriebstechnik GmbH + Co. KG

Kieselbronner Strasse 12

75177 Pforzheim, Germany

24.2 Your opinion is important to us

We created this documentation to the best of our knowledge with the goal of helping you build and expand your expertise productively and efficiently with our products.

Your suggestions, opinions, wishes and constructive criticism help us to ensure and further develop the quality of our documentation.

If you want to contact us for a specific reason, we would be happy to receive an e-mail from you at:

documentation@stoeber.de

Thank you for your interest.

Your STÖBER editorial team

24.3 Close to customers around the world

We offer you committed, expert advice and support in over 40 countries worldwide:

STOBER AUSTRIA

www.stoerber.at
+43 7613 7600-0
sales@stoerber.at

STOBER FRANCE

www.stoerber.fr
+33 478 98 91 80
sales@stoerber.fr

STOBER ITALY

www.stoerber.it
+39 02 93909570
sales@stoerber.it

STOBER KOREA

www.stoerber.kr
+82 10 5681 6298
sales@stoerber.kr

STOBER SWITZERLAND

www.stoerber.ch
+41 56 496 96 50
sales@stoerber.ch

STOBER TURKEY

www.stoerber.com
+90 216 510 2290
sales-turkey@stoerber.com

STOBER USA

www.stoerber.com
+1 606 759 5090
sales@stoerber.com

STOBER CHINA

www.stoerber.cn
+86 512 5320 8850
sales@stoerber.cn

STOBER Germany

www.stoerber.de
+49 7231 582-0
sales@stoerber.de

STOBER JAPAN

www.stoerber.co.jp
+81-3-5875-7583
sales@stoerber.co.jp

STOBER SWEDEN

www.stoerber.com
+46 702 394 675
neil.arstad@stoerber.de

STOBER TAIWAN

www.stoerber.tw
+886 4 2358 6089
sales@stoerber.tw

STOBER UK

www.stoerber.co.uk
+44 1543 458 858
sales@stoerber.co.uk

Glossary

100Base-TX

Ethernet network standard based on symmetrical copper cables in which the nodes are connected to a switch via copper cables twisted in pairs (shielded twisted pair, CAT 5e quality level). 100Base-TX is the subsequent progression from 10Base-T and includes those properties with the option of a transfer speed of 100 Mbps (Fast Ethernet).

Band

In the context of a scope, a section in the display of a scope image. The recorded channels can be individually assigned, each to one such section.

Braking resistor

Electrical resistor that is switched on by a brake chopper in order to avoid a hazard to electrical components in the event of significant brake energy by limiting the DC link voltage. Braking energy, which is usually only present for brief periods, is converted into heat in the resistor.

Broadcast domain

Logical grouping of network devices within a local network that reaches all nodes via broadcast.

Channel (scope, multi-axis scope)

The reserved disk space for recording a signal in DriveControlSuite. As part of a scope image, up to 12 channels can be recorded simultaneously.

Channel assignment

Source of the data that is recorded with/by/in a channel. For example, this may involve parameters that are transmitted in a cyclical fieldbus communication channel or a parameter that is recorded in a measurement channel.

Circuit breakers

Current-limiting switches for motor or starter protection. They guarantee safe shut-off in the event of a short-circuit and protect loads and systems from overload.

Control cascade

Complete model of the control structure with the position controller, velocity controller and current controller components.

Current controller

Controller that is part of the control cascade and makes sure the deviation between the set and actual torque/force is small. In addition, it uses the deviation to calculate a value for the set current and transfers this to the power unit. The controller has a part that controls torque/force and a part that controls the magnetic flux.

Cyclic redundancy check (CRC)

Procedure for determining a check value for data in order to detect errors during transmission or saving.

DC link discharge time

Time until the DC link capacitors are discharged enough that the device can be worked on safely.

Defense in depth

In accordance with DIN EN IEC 62443-4-1, an approach to defend the system against any kind of attack using multiple independent methods.

Demilitarized zone (DMZ)

Specially controlled network located between the external network (Internet) and internal network. It represents a kind of buffer zone that separates the networks from each other through strict communication rules and firewalls.

Differential (HTL/TTL)

In the context of signal transmission, a process for being able to transmit signals with the highest possible fault tolerance even with longer transmission paths. In this approach, transmission takes place using a pair of signal conductors instead of just one signal conductor. The actual signal is transmitted on one line and the inverse signal on the other.

Discrete Fourier transform (DFT)

Maps a time-discrete signal onto a periodic, discrete frequency spectrum. A Fourier transform can be carried out on a scope image in DriveControlSuite. The spectrum display of the scope image shows all occurring frequencies. The amplitude of a frequency stands for its frequency of occurrence.

Electronic nameplate

The synchronous servo motors are generally equipped with absolute encoders that provide special memory. This memory includes the electronic nameplate, i.e. all type-relevant master data as well as special mechanical and electronic values of a motor. When you operate a drive controller with a synchronous servo motor and an absolute encoder, the electronic nameplate is read and all motor data transferred if the drive controller is connected online. The drive controller automatically determines the associated limit values and control parameters from this data.

Emergency stop

An energy supply to the machine drives that could cause a dangerous situation must either be immediately interrupted (stop category 0) or controlled so that the dangerous movement is stopped as quickly as possible (stop category 1) without creating other risks.

Fail Safe over EtherCAT (FSoE)

Protocol for transferring safety-related data via EtherCAT using a FSoE MainInstance and an indefinite number of FSoE SubInstances (i.e. devices that have a Safety over EtherCAT interface). The protocol enables the realization of functional safety via EtherCAT. FSoE and its implementation are TÜV-certified and comply with the SIL 3 requirements in accordance with IEC 61508.

Firewall

Network security device that monitors incoming and outgoing network traffic and decides whether to allow or block specific traffic based on a set of defined security rules. It is based either on hardware, software or a combination of both.

Frequency analysis

Method for investigating how frequently certain events occur in a certain time span, or how strongly which frequency components are represented in a signal.

i²t model

Computational model for thermal monitoring.

i²t value

Criterion for short-term overload capacity.

Industrial Internet of Things (IIoT)

Subgroup of the Internet of Things (IoT) that focuses specifically on the application of IoT technologies in industrial environments, including manufacturing, logistics and other sectors. The focus is on improving industrial processes, efficiency, automation and real-time data collection. It is about optimizing operations, reducing downtime and maximizing productivity.

IPv4 limited broadcast

Type of broadcast in a network with IPv4 (Internet Protocol version 4). The IP address 255.255.255.255 is entered as the destination. The content of the broadcast is not forwarded by a router, which limits it to the local network.

I-share

Integral share of the controller that acts on the manipulated variable through the temporal integration of the control deviation with the weighting caused by the reset time: the longer the control difference is present, the stronger the response is.

Life performance indicator

Value for the calculated life performance of the geared motor.

Load matrix

Recording of the frequency distribution of speeds and torques that occurred at the output of the geared motor.

Miniature circuit breakers

Special switch that protects electrical systems from overload and short-circuits. It is specifically used for the fuse protection of individual cores or cables. The switch has different triggering characteristics (A, B, C, D) and, thus, serves all application areas in industrial, functional and residential construction.

Multi-axis scope

Analysis tool of DriveControlSuite with graphical output. It can be used to create synchronized scope images of multiple drive controllers or axes in order to measure and depict the progress of parameter values, signal names or physical addresses over time.

MV number

The number of the material variant ordered and delivered as stored in the enterprise resource planning system, i.e. the device-specific combination of all hardware and software components.

Network Time Protocol (NTP)

Standard for synchronizing clocks in computer systems via packet-based communication networks. The protocol uses the connectionless transport protocol UDP or the connection-based TCP. It is specifically designed to provide reliable timing over networks with variable packet runtime.

Output choke

Choke type that delays the current increase at the input of the drive controller or supply module in order to reduce the harmonics in the supply grid and reduces the load of the power feed-in of the devices.

P controller

Controller type in which the manipulated variable is always proportional to the recorded control difference. As a result of this, the controller responds to the control deviation without a delay and only creates a manipulated variable if a deviation is present. It is a fast and stable controller with a permanent control deviation that can be used for non-critical controls where permanent control deviation can be accepted when faults occur, e.g. pressure, flow, fill level and temperature control.

Performance Level (PL)

In accordance with DIN EN ISO 13849-1: Measure for the reliability of a safety function or a component. The Performance Level is measured on a scale of a – e (lowest – highest PL). The higher the PL, the safer and more reliable the function in question is. The PL can be assigned to a specific SIL. A reversed inference from a SIL to a PL is not possible.

PI controller

Controller type that results from a parallel connection of a P and an I-controller. With the right layout, it combines the advantages of both types (stable and fast, no permanent control deviation) and compensates for the disadvantages simultaneously.

PID controller

Universal controller type with a P-, I- and D-share. These three adjustment parameters make the controller flexible and ensure exact and highly dynamic control. However, by implication, it also necessitates a wide variety of variants. It is that much more important to ensure careful construction that is well-coordinated to the system. The application areas for this controller type are control circuits with systems of the second order and higher, which must be stabilized quickly and do not allow for any permanent control deviation.

Plug connectors

Component for disconnecting and connecting cables. The connecting parts are appropriately aligned by the positive locking of the plug pieces, feature detachable, positive attachment by spring force (pin) and are often also secured against unintended disconnection by a screw connection.

Position controller

Controller that is part of the control cascade and makes sure the deviation between the set and actual position is small. To do so, it calculates a set velocity from the deviation and passes it to the velocity controller.

Predictive Maintenance (PRM)

Proactive maintenance process based on permanent monitoring and evaluation of machine and process data. The aim here is to predict future maintenance requirements, thereby avoiding faults and making maintenance processes more efficient.

Pre-trigger

Percentage portion of the recording time that takes place before the trigger and that defines the starting time of the scope image.

Pre-trigger time

Portion of the recording time that takes place before the trigger and that defines the starting time of the scope image.

PROFIdrive

Standardized drive interface for PROFIBUS and PROFINET open standard buses. It defines the device behavior and procedure for accessing internal device data for electrical drives on PROFINET and PROFIBUS. The interface is specified by PROFIBUS and PROFINET International (PI) user organizations, and is specified as the future-proof standard by standard IEC 61800-7-303.

PROFINET

Open Ethernet standard of PROFIBUS Nutzerorganisation e. V. (PNO) for automation.

PROFINET IRT

Transmission method for high-precision as well as synchronized processes in a PROFINET IO system.

PROFINET RT

Transmission method for time-critical process data in a PROFINET IO system.

PROFIsafe

Communication standard for safety standard IEC 61508 that includes both standard as well as fail-safe communication. The standard enables reliable communication for PROFIBUS and PROFINET open standard buses based on standard network components, and is defined as the international standard in standard IEC 61784-3-3.

P-share

Proportional share of the controller gain: the greater this share is, the stronger the influence on the manipulated variable.

PTC thermistor

Thermistor whose resistance significantly changes with the temperature. When a PTC reaches its defined nominal response temperature, the resistance increases dramatically, by two or more times the original resistance, to several kOhms. Since PTC triplets are used, each thermistor monitors one phase of the motor winding. For 3 thermistors, this means all 3 phases are monitored, achieving effective motor protection.

Quantization

Conversion of analog signals into numbers and measurable variables. For this purpose, the analog signals are scanned in regular intervals at the sampling rate and their voltage rating is converted at each of these scanning points to a digital value. The analog signal can only be expressed in a finite number of digital values.

Recording time

Recording of an image, occurrence, acoustic event or other event on a corresponding medium. In the context of a scope, the display of the calculated duration of scope image recording. The memory size, sampling time and channels used form the basis of the calculation.

Reforming

Protective measure for drive controllers. In case of a longer storage time, the oxide layer of the capacitors reacts with the electrolytes. This influences the electrical strength and capacitance. The process to be performed before commissioning re-establishes the dielectric in the capacitors.

Reverse documentation

Refers to a read-only file read out by a drive controller that includes the fault memory in addition to the configuration of a drive controller. This file is a snapshot of the time that the connection between the PC and drive controller was interrupted. The information it contains is used for diagnostics as well as for processing service requests.

RFC

Proposed and published Internet standards, reviewed by the Internet Engineering Task Force (IETF), as consensus-building body that facilitates discussion, and eventually a new standard is established.

Safe Brake Control (SBC)

In accordance with DIN EN 61800-5-2: A safety function that provides safe output signals for controlling external brakes.

Safe Direction (SDI)

In accordance with DIN EN 61800-5-2: A safety function that prevents the motor shaft from moving in the unintended direction.

Safe Stop 1 (SS1)

In accordance with DIN EN 61800-5-2: Procedure for stopping a PDS(SR). With the SS1 safety function, the PDS(SR) performs one of the following functions: a) Triggering and controlling the motor delay variable within defined limits and triggering the STO function if the motor speed falls below a specified limit value (SS1-d), or b) triggering and monitoring the motor delay variable within defined limits and triggering the STO function if the motor speed falls below a specified limit value (SS1-r), or c) triggering the motor delay and triggering the STO function after an application-specific delay (SS1-t). In this case, SS1(-t) corresponds to the time-controlled stop in accordance with IEC 60204-1, stop category 1(-t).

Safe Stop 2 (SS2)

In accordance with DIN EN 61800-5-2: Procedure for stopping a PDS(SR). For the safety function SS2, the PDS(SR) performs one of the following functions: a) Initiation and control of the size of the motor delay within defined limits and triggering the SOS function when the motor speed drops below a defined limit value, or b) Initiation and monitoring of the size of the motor delay within defined limits and initiation of the SOS function when the motor speed drops below a limit value, or c) initiation of the motor delay and initiation of the SOS function after an application-specific time delay. This safety function corresponds to a controlled stop according to IEC 60204-1, stop category 2.

Safe Torque Off (STO)

In accordance with DIN EN 61800-5-2: Procedure for stopping a PDS(SR). The STO safety function prevents the motor from being supplied with any energy that could cause rotation (or motion in a linear motor). The PDS(SR) does not supply the motor with any energy that could generate torque (or force in a linear motor). STO is the most fundamental drive-integrated safety function. It corresponds to an uncontrolled stop in accordance with DIN EN 60204-1, stop category 0.

Safely-Limited Increment (SLI)

In accordance with DIN EN 61800-5-2: A safety function that prevents the motor shaft from exceeding a position increment limit.

Safely-Limited Speed (SLS)

In accordance with DIN EN 61800-5-2: A safety function that prevents the motor from exceeding the defined velocity limit.

Safety Integrity Level (SIL)

In accordance with DIN EN 61800-5-2: Probability of a safety function failure. SIL is divided into levels 1 – 4 (lowest – highest level). SIL precisely assesses systems or subsystems based on the reliability of their safety functions. The higher the SIL, the safer and more reliable the function in question is.

Sampling time

In signal processing, the time after which an analog signal (also called a continuous-time signal) is scanned again, i.e. measured and converted into a discrete-time signal.

Scope

Analysis tool of DriveControlSuite with graphical output. It can be used to create scope images of a drive controller in order to measure and depict the progress of parameter values, signal names or physical addresses over time. The term stems from traditional scope-type measuring instruments.

Scope memory

Disk space in the drive controller that records the data of a scope image.

Security

Term for the protection and safety of components and systems with regard to confidentiality, integrity and availability.

Self-discharge

Passive running process that causes the capacitors to discharge even when no electrical load is connected.

Serial number

Consecutive number stored for a product in the enterprise resource planning system and used for individual identification of the product and for determining the associated customer information.

Short-circuit current rating (SCCR)

Characteristic of electrotechnical components or modules. It is defined as the maximum short-circuit current that a component or system must safely withstand.

Simple Network Time Protocol (SNTP)

Simplified version of the Network Time Protocol (NTP). The structure of the protocol is identical to that of NTP. SNTP clients can thus also obtain the time from NTP servers. The main difference lies in the algorithms used for time synchronization. While NTP usually uses multiple time servers for time synchronization, SNTP uses only one time server.

Single-ended (HTL/TTL)

In the context of signal transmission, electrical signal transmission takes place using a voltage that changes in relation to a constant reference potential.

Synchronous operation

Synchronous movement of the individual axes in multi-axis systems.

System parameter

Parameter that is defined by the firmware. Examples include parameters for motor control, for encoders or parameters of the control cascade.

Template

In the context of the DriveControlSuite commissioning software, a template for graphical programming. This template can be selected in the configuration dialog for device control, communication (fieldbus) or application in a certain version.

Time between two energizing processes

Specified time span between two switching-on processes.

Trigger

Switch or software function that generates a pulse or a switching operation during a triggering event.

Trigger condition

Triggering event that generates a pulse or switching operation.

Velocity controller

Controller that is part of the control cascade and makes sure the deviation between the set and actual velocity is small. In addition, it uses the deviation to calculate a value for the set torque/force and transfers this to the current controller.

Window function

Auxiliary function for minimizing the leakage effect for the Fourier transform.

List of figures

Fig. 1	Defense in depth concept	24
Fig. 2	System overview	27
Fig. 3	SC6A062 nameplate	28
Fig. 4	Sticker with MV and serial number	30
Fig. 5	Asymmetric load on double-axis controllers.....	46
Fig. 6	SC6 dimensional drawing	52
Fig. 7	DL6B dimensional drawing.....	55
Fig. 8	FZMU (1), FZZMU (2) dimensional drawing.....	66
Fig. 9	GVADU, GBADU dimensional drawing	68
Fig. 10	TEP dimensional drawing	70
Fig. 11	Grounding concept in mixed operation of SI6 and SC6 with powered SB6 drive controller.....	75
Fig. 12	Derating the nominal current depending on the clock frequency, TEP3720-0ES41	77
Fig. 13	Derating the nominal current depending on the clock frequency, TEP3820-OCS41	77
Fig. 14	Derating the nominal current depending on the clock frequency, TEP4020-ORS41	78
Fig. 15	Derating the nominal current based on surrounding temperature	78
Fig. 16	Derating the nominal current depending on installation elevation.....	78
Fig. 17	Derating the voltage depending on installation elevation.....	79
Fig. 18	Voltage levels dependent on storage time	81
Fig. 19	Fields on the front of the device for identification	82
Fig. 20	Minimum clearances	84
Fig. 21	SC6 and DL6B drilling diagram	85
Fig. 22	FZMU, FZZMU drilling diagram.....	86
Fig. 23	GVADU, GBADU drilling diagram.....	86
Fig. 24	TEP drilling diagram.....	87
Fig. 25	Determination of the correct length of the copper rails.....	88
Fig. 26	Connection of the grounding conductor	102
Fig. 27	Connection of the grounding conductor	103
Fig. 28	Connection overview using the example of the SC6A162.....	105
Fig. 29	FZMU connection overview	133
Fig. 30	FZZMU connection overview.....	133
Fig. 31	TEP output choke connection example.....	134
Fig. 32	Shielded connection of the power cable.....	135
Fig. 33	LEDs for the functions of the S1 operating button.....	156
Fig. 34	DS6: Program interface	157
Fig. 35	Structure of the control cascade	181

Fig. 36	Schematic sequence of optimization based on relevant parameters	185
Fig. 37	Velocity controller – Filters for the actual velocity	187
Fig. 38	Velocity controller – Proportional coefficient	189
Fig. 39	Scope – Proportional coefficient of the velocity controller (C31), default value	190
Fig. 40	Scope – Proportional coefficient of the velocity controller (C31), continuous oscillations	190
Fig. 41	Scope – Proportional coefficient of the velocity controller (C31), optimized value	191
Fig. 42	Scope – Proportional coefficient of the velocity controller (C31), overshooting	192
Fig. 43	Velocity controller – Integral coefficient	193
Fig. 44	Scope – Integral coefficient of the velocity controller (C32)	194
Fig. 45	Position controller – Proportional coefficient	195
Fig. 46	Position controller – Feedforward control of the velocity controller	196
Fig. 47	Scope – Motor reaches saturation without tracking (B59)	197
Fig. 48	Scope – Motor reaches saturation with tracking (B59)	198
Fig. 49	Brake control in Drive Based applications	205
Fig. 50	Brake control in CiA 402 applications	205
Fig. 51	Brake control in PROFIdrive applications	205
Fig. 52	Brake control for control mode B20 = 0: ASM - V/f-control or 1: ASM - V/f-slip compensated	209
Fig. 53	Brake control for control mode B20 = 2: ASM - vector control	210
Fig. 54	Brake control for control mode B20 = 3: ASM - sensorless vector control	211
Fig. 55	Brake control for control mode B20 = 32: LM - sensorless vector control, 48: SSM-vector control incremental encoder, 64: SSM - vector control or 70: SLM - vector control	212
Fig. 56	Minimum time between 2 release processes for the brake	215
Fig. 57	Scaling of the recorded speed classes	232
Fig. 58	Scaling of the recorded torque classes	233
Fig. 59	Signaling area	241
Fig. 60	Predictive Maintenance: Options for readout	243
Fig. 61	Positions of the diagnostic LEDs on the front and top of the drive controller	245
Fig. 62	LEDs for the state of the drive controller	246
Fig. 63	LEDs for the EtherCAT state	249
Fig. 64	LED for the FSoE state	250
Fig. 65	LED for the FSoE state	251
Fig. 66	LEDs for the PROFINET state	252
Fig. 67	LED for the PROFIsafe state	253
Fig. 68	LEDs for the state of the service network connection	254
Fig. 69	LEDs for the state of the EtherCAT network connection	255
Fig. 70	LEDs for the state of the PROFINET network connection	256

Fig. 71	Scope and multi-axis scope: Program interface	318
Fig. 72	Scope and multi-axis scope: Image editor.....	326
Fig. 73	Multi-axis scope: Network structure.....	334
Fig. 74	Wiring example with direct brake control.....	358
Fig. 75	Wiring example with Quick DC-Link	359
Fig. 76	DriveControlSuite: Establishing a connection	369
Fig. 77	Script mode: Program interface	376
Fig. 78	Test setup of the application examples	394

List of tables

Tab. 1	Described product types, SC6 drive controllers	11
Tab. 2	File number-certified products	12
Tab. 3	Short-circuit current rating (SCCR)	18
Tab. 4	Short-circuit current rating (SCCR)	25
Tab. 5	Meaning of the specifications on the nameplate	29
Tab. 6	Example code for type designation	30
Tab. 7	Meaning of the example code	30
Tab. 8	Meaning of the specifications on the sticker	30
Tab. 9	Available SC6 types and sizes	31
Tab. 10	Device features	40
Tab. 11	Transport and storage conditions	40
Tab. 12	Operating conditions	41
Tab. 13	Discharge times of the DC link circuit	41
Tab. 14	Control unit electrical data	41
Tab. 15	SC6 electrical data, size 0	42
Tab. 16	SC6 electrical data, size 0, for 4 kHz clock frequency	42
Tab. 17	SC6 electrical data, size 0, for 8 kHz clock frequency	42
Tab. 18	Brake chopper electrical data, size 0	42
Tab. 19	SC6 electrical data, size 1	43
Tab. 20	SC6 electrical data, size 1, for 4 kHz clock frequency	43
Tab. 21	SC6 electrical data, size 1, for 8 kHz clock frequency	43
Tab. 22	Brake chopper electrical data, size 1	43
Tab. 23	SC6 electrical data, size 2	44
Tab. 24	SC6 electrical data, size 2, for 4 kHz clock frequency	44
Tab. 25	SC6 electrical data, size 2, for 8 kHz clock frequency	44
Tab. 26	Brake chopper electrical data, size 2	44
Tab. 27	Technical data – Inputs and outputs	45
Tab. 28	X101 electrical data – Digital inputs	45
Tab. 29	X103 electrical data – Digital inputs	45
Tab. 30	Power loss data of the SC6 drive controller in accordance with EN 61800-9-2	48
Tab. 31	Absolute losses of the accessories	49
Tab. 32	Cycle times	49
Tab. 33	Nominal output current I _{2N,PU} dependent on the clock frequency	50
Tab. 34	SC6 dimensions [mm]	52
Tab. 35	SC6 weight [g]	52

Tab. 36	Device features.....	53
Tab. 37	Transport and storage conditions	53
Tab. 38	Operating conditions.....	53
Tab. 39	Assignment of DL6B to SC6	54
Tab. 40	DL6B dimensions [mm]	55
Tab. 41	DL6B weight [g]	55
Tab. 42	X12 electrical data – Digital inputs.....	56
Tab. 43	Motor types and control modes	57
Tab. 44	Encoder connections	58
Tab. 45	Signal level encoder inputs, single-ended	59
Tab. 46	Signal levels of encoder inputs, differential	59
Tab. 47	Encoder models with unsuitable supply voltage range.....	59
Tab. 48	X4 technical data – EnDat 2.1 digital signals	60
Tab. 49	X4 technical data – EnDat 2.2 digital signals	60
Tab. 50	X4 technical data – SSI signals with free setting	60
Tab. 51	X4 technical data – SSI signals with fixed setting	61
Tab. 52	X4 technical data – TTL differential incremental signals	61
Tab. 53	X4 technical data – Resolver signals.....	62
Tab. 54	X4 technical data – EnDat 3 signals	62
Tab. 55	X4 technical data – HIPERFACE DSL signals	62
Tab. 56	Maximum core/cable length [m].....	63
Tab. 57	X101 electrical data – Incremental signals, pulse/direction signals, Hall sensor signals, single-ended HTL ...	63
Tab. 58	Maximum core/cable length [m].....	63
Tab. 59	X103 electrical data – Incremental signals, pulse/direction signals, Hall sensor signals, single-ended HTL ...	63
Tab. 60	X2 electrical data – Brake connection	64
Tab. 61	Triggering limit of temperature sensor	64
Tab. 62	Assignment of FZMU, FZZMU braking resistor – SC6 drive controller	65
Tab. 63	FZMU, FZZMU technical data	65
Tab. 64	FZMU, FZZMU dimensions [mm].....	66
Tab. 65	Assignment of GVADU, GBADU braking resistor – SC6 drive controller	67
Tab. 66	GVADU, GBADU technical data	67
Tab. 67	GVADU, GBADU dimensions [mm].....	68
Tab. 68	TEP technical data	69
Tab. 69	TEP dimensions and weight.....	70
Tab. 70	Minimum clearances [mm]	84
Tab. 71	Drilling dimensions for SC6 drive controller [mm]	85

Tab. 72	Drilling dimensions for Quick DC-Link DL6B [mm]	86
Tab. 73	FZMU, FZZMU drilling dimensions [mm].....	86
Tab. 74	GVADU, GBADU drilling dimensions [mm].....	86
Tab. 75	TEP drilling dimensions	87
Tab. 76	Short-circuit current rating (SCCR)	97
Tab. 77	Line fuses in stand-alone operation	97
Tab. 78	Line fuses for DC link connection	98
Tab. 79	UL-compliant line fuses	99
Tab. 80	Minimum cross-section of the grounding conductor.....	101
Tab. 81	X2 connection description, brake or digital output.....	106
Tab. 82	Maximum core/cable length [m].....	106
Tab. 83	X2 connection description, motor temperature sensor.....	107
Tab. 84	Maximum cable length [m]	107
Tab. 85	Encoder models with unsuitable supply voltage range.....	108
Tab. 86	X4 connection description for EnDat 2.1/2.2 digital encoders and SSI encoders	109
Tab. 87	X4 connection description for differential TTL and differential HTL incremental encoders (HTL via HT6 adapter).....	110
Tab. 88	X4 connection description for resolvers.....	111
Tab. 89	X4 connection description for EnDat 3 and HIPERFACE DSL encoders	112
Tab. 90	Maximum cable length [m]	112
Tab. 91	HT6 connection description for HTL differential encoder (15-pin to 15-pin).....	113
Tab. 92	AP6A00 connection description for resolver (9-pin to 15-pin)	114
Tab. 93	AP6A01 connection description for the resolver and motor temperature sensor (9-pin to 15-pin)	115
Tab. 94	X9 connection description.....	116
Tab. 95	Maximum cable length [m]	116
Tab. 96	Cable requirements.....	116
Tab. 97	X10 connection description, size 0.....	117
Tab. 98	X10 connection description, sizes 1 and 2	117
Tab. 99	Control unit electrical data.....	118
Tab. 100	X11 connection description.....	118
Tab. 101	Maximum core/cable length [m].....	118
Tab. 102	X12 connection description.....	119
Tab. 103	Maximum core/cable length [m].....	119
Tab. 104	X20 connection description, size 0.....	120
Tab. 105	X20 connection description, sizes 1 and 2	120
Tab. 106	Maximum cable length of the power cable [m]	120

Tab. 107	X21 connection description, size 0.....	121
Tab. 108	X21 connection description, sizes 1 and 2	121
Tab. 109	Maximum core/cable length [m].....	121
Tab. 110	X22 connection description, size 0.....	122
Tab. 111	X22 connection description, sizes 1 and 2	122
Tab. 112	Maximum core/cable length [m].....	122
Tab. 113	X101 connection description for digital signals.....	123
Tab. 114	Maximum core/cable length [m].....	123
Tab. 115	X101 connection description for single-ended HTL incremental signals, axis A	123
Tab. 116	X101 connection description for single-ended HTL pulse/direction signals, axis A	124
Tab. 117	X101 connection description for single-ended HTL Hall sensor signals, axis A	124
Tab. 118	Maximum core/cable length [m].....	124
Tab. 119	X103 connection description for digital signals.....	125
Tab. 120	Maximum core/cable length [m].....	125
Tab. 121	X103 connection description for single-ended HTL incremental signals, axis B.....	125
Tab. 122	X103 connection description for single-ended HTL pulse/direction signals, axis B	126
Tab. 123	X103 connection description for single-ended HTL Hall sensor signals, axis B	126
Tab. 124	Maximum core/cable length [m].....	126
Tab. 125	X200 and X201 connection description.....	127
Tab. 126	X200 and X201 connection description.....	128
Tab. 127	X300 electrical data – Supply of brakes and digital outputs	129
Tab. 128	X300 connection description.....	129
Tab. 129	Maximum core/cable length [m].....	129
Tab. 130	FZMU, FZZMU connection description.....	133
Tab. 131	GVADU, GBADU connection description.....	133
Tab. 132	TEP output choke connection description	134
Tab. 133	Maximum cable length of the power cable [m]	137
Tab. 134	con.15 power cable pin assignment.....	138
Tab. 135	con.15 connector dimensions	138
Tab. 136	con.23 power cable pin assignment.....	138
Tab. 137	con.23 connector dimensions	138
Tab. 138	con.40 power cable pin assignment.....	139
Tab. 139	con.40 connector dimensions	139
Tab. 140	con.15 encoder cable pin assignment, EnDat 2.1/2.2 digital	141
Tab. 141	con.15 connector dimensions	141
Tab. 142	con.17 encoder cable pin assignment, EnDat 2.1/2.2 digital	142

Tab. 143	con.17 connector dimensions	142
Tab. 144	con.23 encoder cable pin assignment, EnDat 2.1/2.2 digital	143
Tab. 145	con.23 plug dimensions.....	143
Tab. 146	con.23 encoder cable pin assignment, SSI	144
Tab. 147	con.23 plug dimensions.....	144
Tab. 148	con.23 encoder cable pin assignment, incremental HTL.....	145
Tab. 149	con.23 plug dimensions.....	145
Tab. 150	Encoder cable pin assignment con.15, resolver, "No. 44206" cable label	147
Tab. 151	con.15 connector dimensions	147
Tab. 152	Encoder cable pin assignment con.17, resolver, "No. 44206" cable label	148
Tab. 153	con.17 connector dimensions	148
Tab. 154	Encoder cable pin assignment con.23, resolver, "No. 44206" cable label	149
Tab. 155	con.23 plug dimensions.....	149
Tab. 156	Encoder cable pin assignment con.15, resolver, "Motion Resolver" cable label	150
Tab. 157	con.15 connector dimensions	150
Tab. 158	Encoder cable pin assignment con.17, resolver, "Motion Resolver" cable label	151
Tab. 159	con.17 connector dimensions	151
Tab. 160	Encoder cable pin assignment con.23, resolver, "Motion Resolver" cable label	152
Tab. 161	con.23 plug dimensions.....	152
Tab. 162	con.23 hybrid cable pin assignment.....	154
Tab. 163	con.23 connector dimensions	154
Tab. 164	Status of the LEDs when selecting functions via the S1 operating button	156
Tab. 165	Parameter groups.....	159
Tab. 166	Parameters: Data types, parameter types, possible values	160
Tab. 167	Parameter types.....	161
Tab. 168	Requirements for a direct connection	179
Tab. 169	Guide values for C34	187
Tab. 170	Application cases for the brake test and safe brake management	199
Tab. 171	Information on the load matrix.....	235
Tab. 172	Load matrix: Impermissible characters or control characters.....	236
Tab. 173	Predictive Maintenance files on SD card.....	244
Tab. 174	Meaning of file extensions on SD card	244
Tab. 175	Meaning of the green LED (Run)	246
Tab. 176	Meaning of the red LEDs (error).....	247
Tab. 177	States of the LEDs when starting the drive controller	247
Tab. 178	States of the LEDs when identifying the drive controller in the network	247

Tab. 179	States of the LEDs when using an SD card to transfer a firmware file	248
Tab. 180	States of the LEDs after transferring a firmware file and restarting the drive controller	248
Tab. 181	Meaning of the red LED (error)	249
Tab. 182	Meaning of the green LED (Run)	249
Tab. 183	Meaning of the green LED (FSoE status indicator in accordance with IEC 61784-3)	250
Tab. 184	Meaning of the green LED	251
Tab. 185	Meaning of the red LED (BF)	252
Tab. 186	Meaning of the green LED (Run)	252
Tab. 187	Meaning of the green LED (PROFIsafe status indicator in accordance with IEC 61784-3)	253
Tab. 188	Meaning of the green LED (link)	254
Tab. 189	Meaning of the yellow LED (act.)	254
Tab. 190	Meaning of the green LEDs (LA)	255
Tab. 191	Meaning of the green LEDs (Link)	256
Tab. 192	Meaning of the yellow LEDs (Act.)	256
Tab. 193	Events	258
Tab. 194	Event 31 – Causes and actions	260
Tab. 195	Event 32 – Causes and actions	261
Tab. 196	Event 33 – Causes and actions	262
Tab. 197	Event 34 – Causes and actions	263
Tab. 198	Event 35 – Causes and actions	264
Tab. 199	Event 36 – Causes and actions	264
Tab. 200	Event 37 – Causes and actions	266
Tab. 201	Event 38 – Causes and actions	268
Tab. 202	Event 39 – Causes and actions	269
Tab. 203	Event 40 – Causes and actions	270
Tab. 204	Event 41 – Causes and actions	271
Tab. 205	Event 42 – Causes and actions	272
Tab. 206	Event 44 – Causes and actions	273
Tab. 207	Event 45 – Causes and actions	274
Tab. 208	Event 46 – Causes and actions	275
Tab. 209	Event 47 – Causes and actions	276
Tab. 210	Event 48 – Causes and actions	277
Tab. 211	Event 49 – Causes and actions	278
Tab. 212	Event 50 – Causes and actions	279
Tab. 213	Event 51 – Causes and actions	281
Tab. 214	Event 52 – Causes and actions	282

Tab. 215	Event 53 – Causes and actions	283
Tab. 216	Event 54 – Causes and actions	284
Tab. 217	Event 56 – Causes and actions	285
Tab. 218	Event 57 – Causes and actions	286
Tab. 219	Event 59 – Causes and actions	287
Tab. 220	Events 60 – 67 – Causes and actions	288
Tab. 221	Event 68 – Causes and actions	289
Tab. 222	Event 69 – Causes and actions	290
Tab. 223	Event 70 – Causes and actions	291
Tab. 224	Event 71 – Causes and actions	293
Tab. 225	Event 76 – Causes and actions	295
Tab. 226	Event 77 – Causes and actions	297
Tab. 227	Event 78 – Causes and actions	299
Tab. 228	Event 79 – Causes and actions	300
Tab. 229	Event 80 – Causes and actions	301
Tab. 230	Event 81 – Causes and actions	302
Tab. 231	Event 83 – Causes and actions	303
Tab. 232	Event 84 – Causes and actions	305
Tab. 233	Event 85 – Causes and actions	306
Tab. 234	Event 85 – Causes and actions	307
Tab. 235	Event 87 – Causes and actions	308
Tab. 236	Event 88 – Causes and actions	308
Tab. 237	Event 89 – Causes and actions	309
Tab. 238	Event 90 – Causes and actions	310
Tab. 239	Error list of the SX6 safety module.....	311
Tab. 240	Application cases for scope and multi-axis scope	317
Tab. 241	Weights of SC6 and accessories	351
Tab. 242	Terminal specifications for the base device	352
Tab. 243	Terminal specifications of the safety technology.....	352
Tab. 244	Terminal specifications for the braking resistors	352
Tab. 245	BCF 3,81 180 SN BK specification	353
Tab. 246	BLDF 5.08 180 SN specification	353
Tab. 247	FMC 1,5 -ST-3,5 specification	354
Tab. 248	G 10/2 specification	354
Tab. 249	GFKC 2,5 -ST-7,62 specification	355
Tab. 250	Specification for GFKIC 2.5 -ST-7.62	355

Tab. 251	ISPC 5 -STGCL-7,62 specification	356
Tab. 252	SPC 16 -ST-10,16 specification	356
Tab. 253	SPC 5 -ST-7,62 specification	357
Tab. 254	Overview of hardware components with ID No.....	360
Tab. 255	Evaluation of an SSI encoder at X4 with free setting	361
Tab. 256	Evaluation of an SSI encoder at X4 with fixed setting	362
Tab. 257	Examples of rotational SSI encoders at X4	363
Tab. 258	Examples of translational SSI encoders at X4.....	363
Tab. 259	Commutation finding with control mode B20 = 48 or 70	364
Tab. 260	Programs and services.....	368
Tab. 261	Protocols and ports for a direct connection.....	368
Tab. 262	Script mode commands.....	379
Tab. 263	Script mode: Variables for importing and exporting parameters	388
Tab. 264	Script mode: Variables for importing and exporting parameters	389
Tab. 265	Script mode: Exit statuses	397

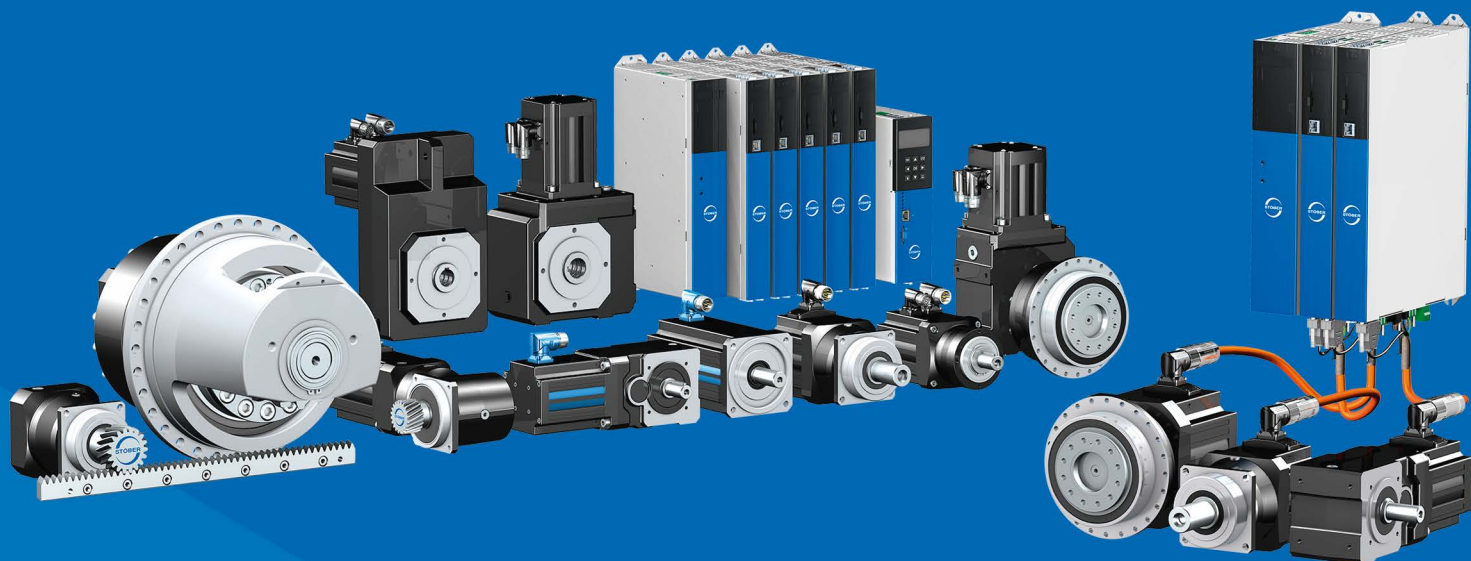

4 4 2 7 9 0 . 0 9

11/2024

STÖBER Antriebstechnik GmbH + Co. KG
Kieselbronner Str. 12
75177 Pforzheim
Germany
Tel. +49 7231 582-0
mail@stoerber.de
www.stoerber.com

24 h Service Hotline
+49 7231 582-3000



STÖBER

www.stoerber.com