

PROFI[®] NET

PROFINET – SD6 Manual

en-US
08/2024
ID 442710.05

Table of contents

- Table of contents 2**
- 1 Foreword 5**
- 2 User information 6**
 - 2.1 Storage and transfer 6
 - 2.2 Described product 6
 - 2.3 Directives and standards 6
 - 2.4 Timeliness 6
 - 2.5 Original language 6
 - 2.6 Limitation of liability 6
 - 2.7 Formatting conventions 7
 - 2.7.1 Display of warning messages and information 7
 - 2.7.2 Markup of text elements 8
 - 2.7.3 Mathematics and formulas 8
 - 2.8 Trademarks 9
 - 2.9 Explanation of terms 9
- 3 Safety notes 10**
- 4 Network structure 11**
- 5 PN6 communication module 12**
 - 5.1 Installation 12
- 6 Connection 13**
 - 6.1 Selecting suitable cables 13
 - 6.2 X200, X201: Fieldbus connection 13
- 7 What you should know before commissioning 14**
 - 7.1 Program interfaces 14
 - 7.1.1 DS6 program interface 14
 - 7.1.2 TIA Portal program interface 18
 - 7.2 Meaning of parameters 20
 - 7.2.1 Parameter groups 20
 - 7.2.2 Parameter types and data types 21
 - 7.2.3 Parameter types 22
 - 7.2.4 Parameter structure 22
 - 7.2.5 Parameter visibility 23
 - 7.3 Signal sources and process data mapping 24
 - 7.4 Non-volatile memory 24

8	Commissioning	25
8.1	DS6: Configuring the drive controller	26
8.1.1	Initiating the project	26
8.1.2	Parameterizing general PROFINET settings	30
8.1.3	Configuring PZD transmission.....	31
8.1.4	Mapping the mechanical axis model	33
8.1.5	Transmitting and saving a configuration	38
8.1.6	Testing the configuration.....	41
8.2	TIA Portal: Setting up a PROFINET network.....	42
8.2.1	Installing the GSD file.....	42
8.2.2	Projecting the PROFINET network	43
8.2.3	Configuring network addresses	44
8.2.4	Configuring the drive controller	45
8.2.5	Transmitting the configuration.....	48
8.2.6	Testing communication	49
9	Monitoring and diagnostics	50
9.1	Connection monitoring.....	50
9.2	LED display.....	51
9.2.1	PROFINET state	51
9.2.2	PROFINET network connection.....	52
9.3	Events	53
9.3.1	Event 52: Communication	54
9.4	Parameters	55
9.4.1	A270 X20x state G6 V0	55
9.4.2	A271 PN state G6 V0	55
9.4.3	A272 PN module/submodule G6 V1.....	56
9.4.4	A273 PN device name G6 V0	56
9.4.5	A274 PN IP address G6 V0	56
9.4.6	A275 PN subnet mask G6 V0	56
9.4.7	A276 PN gateway G6 V0.....	56
9.4.8	A279 PN MAC addresses G6 V0.....	57
10	More on PROFINET?	58
10.1	PROFINET.....	58
10.2	Device classes	58
10.3	Communication	59
10.3.1	Cyclical communication: Process data.....	59
10.3.2	Acyclical communication: Parameter channel data	59
10.3.3	Programming acyclical communication services	63
10.4	Communication protocols	64

- 10.5 Ethernet network addressing 65
 - 10.5.1 MAC address 65
 - 10.5.2 IP address 65
 - 10.5.3 Subnet mask 65
 - 10.5.4 Subnets and gateways 66
 - 10.5.5 MAC and IP addressing using device names 66
- 10.6 Cycle times 66
- 10.7 Activating and executing actions 67
- 10.8 Fieldbus scaling 69
- 11 Appendix 70**
 - 11.1 Addressing parameters for RECORD record 70
 - 11.1.1 Determining the Axis_number 70
 - 11.1.2 Calculating the Parameter_number 70
 - 11.1.3 Determining the subindex 71
 - 11.2 RDREC, WRREC: RECORD 71
 - 11.2.1 WRREC: RECORD request: Header structure 71
 - 11.2.2 RDREC: RECORD response: Header structure 72
 - 11.2.3 RDREC, WRREC: Error codes 73
 - 11.2.4 Attribute and format elements: Possible combinations 74
 - 11.3 Process data modules 75
 - 11.4 Detailed information 76
 - 11.5 Abbreviations 77
- 12 Contact 78**
 - 12.1 Consultation, service and address 78
 - 12.2 Your opinion is important to us 78
 - 12.3 Close to customers around the world 79
- Glossary 80**
- List of figures 82**
- List of tables 83**

1 Foreword

PROFINET, an open industrial Ethernet standard, is especially well-suited for applications that require fast communication with a high data rate combined with industrial IT functions. PROFINET is real-time capable and uses IT standards like TCP/IP.

STOBER drive controllers support PROFINET, a development of the successful PROFIBUS standard. The drive controllers are tailored for real-time communication of I/O data and offer the ability to transfer all required data, parameters and IT functions at the same time.

For drive controllers of the SD6 series, the fieldbus functionality is provided via the PN6 communication module.

2 User information

This documentation supports you in installing and connecting the PN6 communication module in order to connect a drive controller of the SD6 series (IO device) in combination with a controller (IO controller) using a PROFINET network.

Technical knowledge

Operating your PROFINET network requires having familiarity with PROFINET network technology and the basics of the associated Siemens SIMATIC automation systems.

Technical requirements

Before you begin operating your PROFINET network, you need to wire the drive controllers and initially check that they are functioning correctly. To do so, follow the instructions in the manual for the SD6 drive controller.

2.1 Storage and transfer

As this documentation contains important information for handling the product safely and efficiently, it must be stored in the immediate vicinity of the product until product disposal and be accessible to qualified personnel at all times.

Also pass on this documentation if the product is transferred or sold to a third party.

2.2 Described product

This documentation is binding for:

SD6 series drive controllers in combination with the DriveControlSuite software (DS6) in V 6.6-B or later and associated firmware in V 6.6-B or later.

2.3 Directives and standards

Refer to the drive controller documentation for the European directives and standards relevant to the drive controller and accessories.

2.4 Timeliness

Check whether this document is the latest version of the documentation. We make the latest document versions for our products available for download on our website:

<http://www.stoeber.de/en/downloads/>.

2.5 Original language

The original language of this documentation is German; all other language versions are derived from the original language.

2.6 Limitation of liability

This documentation was created taking into account the applicable standards and regulations as well as the current state of technology.

No warranty or liability claims for damage shall result from failure to comply with the documentation or from use that deviates from the intended use of the product. This is especially true for damage caused by individual technical modifications to the product or the project configuration and operation of the product by unqualified personnel.

2.7 Formatting conventions

Orientation guides in the form of signal words, symbols and special text markups are used to emphasize specific information so that you are able identify it in this documentation quickly.

2.7.1 Display of warning messages and information

Warning messages are identified with symbols. They indicate special risks when handling the product and are accompanied by relevant signal words that express the extent of the risk. Furthermore, useful tips and recommendations for efficient, error-free operation are specially highlighted.

ATTENTION!

Attention

This indicates that damage to property may occur

- if the stated precautionary measures are not taken.

⚠ CAUTION!

Caution

This word with a warning triangle indicates that minor personal injury may occur

- if the stated precautionary measures are not taken.

⚠ WARNING!

Warning

This word with a warning triangle means there may be a considerable risk of fatal injury

- if the stated precautionary measures are not taken.

⚠ DANGER!

Danger

This word with a warning triangle indicates that there is a considerable risk of fatal injury

- if the stated precautionary measures are not taken.

Information

Information indicates important information about the product or serves to emphasize a section in the documentation that deserves special attention from the reader.

2.7.2 Markup of text elements

Certain elements of the continuous text are distinguished as follows.

Important information	Words or expressions with a special meaning
Interpolated position mode	Optional: File or product name or other name
<u>Detailed information</u>	Internal cross-reference
http://www.samplelink.com	External cross-reference

Software and other displays

The following formatting is used to identify the various information content of elements referenced by the software interface or a drive controller display, as well as any user entries.

Main menu Settings	Window names, dialog box names, page names or buttons, combined proper nouns, functions referenced by the interface
Select Referencing method A	Predefined entry
Save your <own IP address>	User-defined entry
EVENT 52: COMMUNICATION	Displays (status, messages, warnings, faults)

Keyboard shortcuts and command sequences or paths are represented as follows.

[Ctrl], [Ctrl] + [S]	Key, key combination
Table > Insert table	Navigation to menus/submenus (path specification)

2.7.3 Mathematics and formulas

The following signs are used to represent mathematical relationships and formulas.

–	Subtraction
+	Addition
×	Multiplication
÷	Division
	Absolute value

2.8 Trademarks

The following names used in connection with the device, its optional equipment and its accessories are trademarks or registered trademarks of other companies:

EnDat®	EnDat® and the EnDat® logo are registered trademarks of Dr. Johannes Heidenhain GmbH, Germany.
PROFIBUS®, PROFINET®	PROFIBUS® and PROFINET® are registered trademarks of PROFIBUS Nutzerorganisation e.V., Germany.
SIMATIC®, TIA Portal®	SIMATIC® and TIA Portal® are registered trademarks of Siemens AG, Germany.

All other trademarks not listed here are the property of their respective owners.

Products that are registered as trademarks are not specially indicated in this documentation. Existing property rights (patents, trademarks, protection of utility models) are to be observed.

2.9 Explanation of terms

As relevant standards and products of other manufacturers are referenced, different manufacturer- or standard-specific names are used for the same term in this documentation.

For improved understandability, the names in this documentation are standardized to the terminology of STOBER to the greatest extent possible. The correlation of STOBER names to other sources can be found in the following table.

STOBER	PROFINET
Controller	IO controller
Drive controller	IO device

Tab. 1: Correlation of STOBER terminology to PROFINET

3 Safety notes

WARNING!

Risk of fatal injury if safety notes and residual risks are not observed!

Failure to observe the safety notes and residual risks in the drive controller documentation may result in accidents causing serious injury or death.

- Observe the safety notes in the drive controller documentation.
 - Consider the residual risks in the risk assessment for the machine or system.
-

WARNING!

Malfunction of the machine due to incorrect or modified parameterization!

In the event of incorrect or modified parameterization, malfunctions can occur on machines or systems which can lead to serious injuries or death.

- Observe the security notes in the drive controller documentation.
 - Protect the parameterization, e.g. from unauthorized access.
 - Take appropriate measures for possible malfunctions (e.g. emergency off or emergency stop).
-

4 Network structure

A PROFINET network generally consists of a PROFINET segment with a controller (IO controller) and all IO devices belonging to this segment, i.e. SD6 series drive controllers and a PC as the IO supervisor.

The PROFINET network structure is generally tailored to the specific requirements of the respective system. STOBER drive controllers support a star, line or tree topology.

All PROFINET nodes are integrated into the PROFINET network using internal or external switches (100 Mbps).

You can configure and parameterize the drive controllers using the DriveControlSuite DS6 software from STOBER; Siemens TIA Portal lets you do this for the entire PROFINET network, for instance.

The following graphic presents an abstract of a PROFINET network.

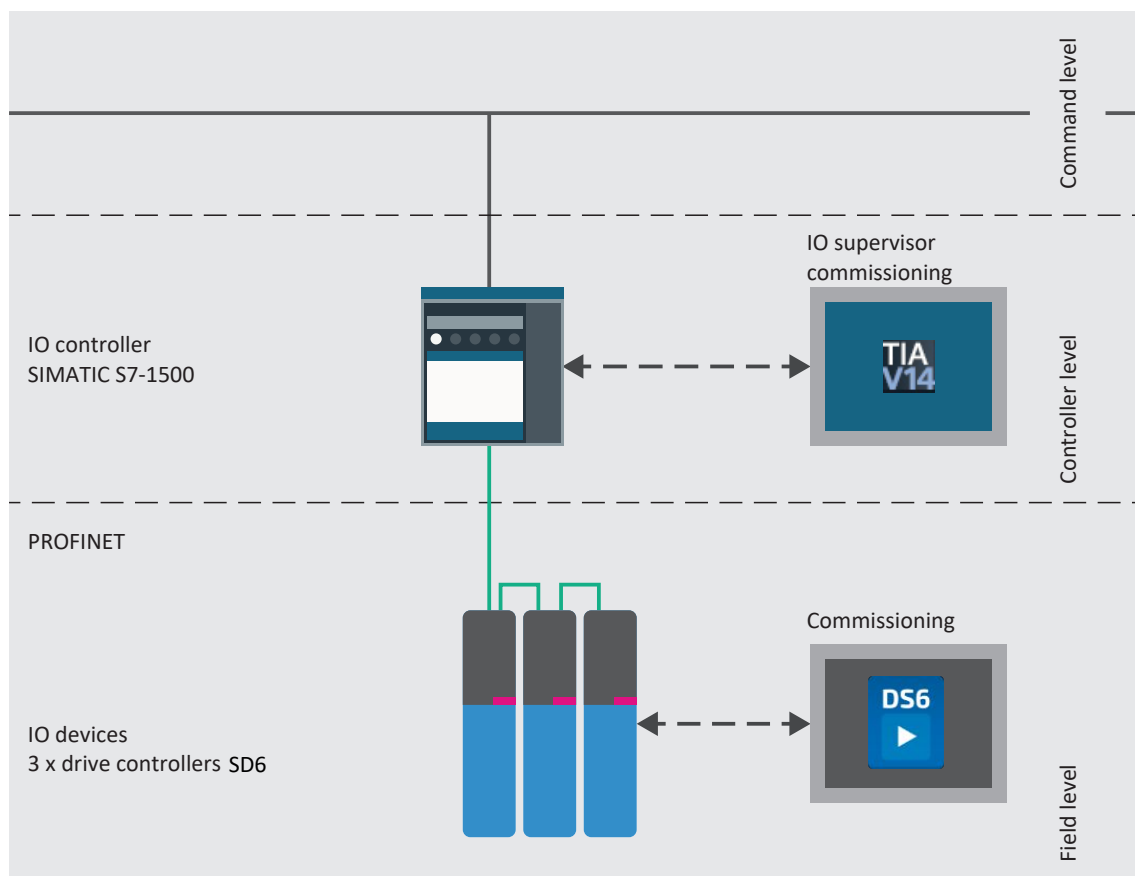

Fig. 1: PROFINET: Network structure

5 PN6 communication module

The drive controllers of the SD6 series are connected with the controller via the PN6 communication module, which provides the necessary fieldbus interface.

The communication module matches the PROFINET standard and enables cyclical and acyclical data exchange between the drive controllers and the controller.

5.1 Installation

Installation work is permitted only when no voltage is present. Observe the 5 safety rules in accordance with DIN VDE 0105.

In order to prevent the drive controller from overheating, note the minimum clearances listed in the technical data during installation.

Protect the device against falling parts (wire scraps, wires, pieces of metal, etc.) during installation or other work in the control cabinet. Parts with conductive properties may result in a short-circuit or failure inside the drive controller.

Remove the additional covers before commissioning so that the drive controller does not overheat.

WARNING!

Electrical voltage! Risk of fatal injury due to electric shock!

Hazardous voltages may be present on the connection terminals and the cables connected to them.

- Always switch off all power supply voltage before working on the devices!
- Note that the discharge time of the DC link capacitors is up to 6 minutes. You can only determine the absence of voltage after this time period.

ATTENTION!

Damage to property due to electrostatic discharge!

Take appropriate measures when handling exposed printed boards, e.g. wearing ESD-safe clothing.

Do not touch contact surfaces.

Tool and material

You will need:

- A TORX screwdriver TX10
- The cover and screws included with the communication module

Installation

1. Unscrew the fastening screw of the dummy cover on top of the drive controller and remove the cover.
2. Slide the communication module on the guide rails into the drive controller.
3. Press on the module in order to push the pin contacts into the box header.
4. Set the tabs of the cover included with the communication module in front in the notch at an angle.
5. Place the cover on the drive controller so that the tabs lie under the edge.
6. Attach the cover using both screws.

6 Connection

For network connection, PROFINET only allows switches; these in turn allow for flexible network structure and nearly unlimited network expansion of several kilometers at maximum speed.

6.1 Selecting suitable cables

The PROFINET transmission technology is based on the Fast Ethernet standard.

The connections between the nodes of a PROFINET network generally consist of symmetrical, shielded copper cables twisted in pairs (shielded twisted pair, CAT 5e quality level). Fiber-optic cables are also a possible means of transmission.

Signals are transmitted according to the 100BASE TX method, i.e. with a transfer rate of 100 Mbps at a frequency of 125 MHz. A maximum of 1440 bytes can be transferred per frame. The maximum cable length is 100 m.

PROFINET cables exist in different versions that are tailored to different application scenarios and ambient conditions.

We recommend using the cables and plug connectors specified in the PROFINET installation guidelines. They are adjusted for use in automation technology with regard to usage, resistance, EMC properties and color coding.

There are type A, B and C cables, differentiated by installation type:

- Type A
4-wire shielded copper cable for fixed installation
- Type B
4-wire shielded copper cable for flexible installation
- Type C
4-wire shielded copper cable for constant movements

6.2 X200, X201: Fieldbus connection

In order to be able to connect the drive controllers to other PROFINET nodes, an integrated switch with both X200 and X201 RJ-45 sockets is provided. The sockets are located on top of the device. The associated pin assignment and color coding correspond to the EIA/TIA-T568B standard.

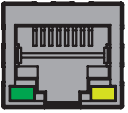
Socket	Pin	Designation	Function
1 2 ... 7 8 	1	Tx+	Communication
	2	Tx-	
	3	Rx+	
	4	—	—
	5	—	—
	6	Rx-	Communication
	7	—	—
	8	—	—

Tab. 2: X200 and X201 connection description

7 What you should know before commissioning

The following chapters provide a quick introduction to the structure of the program interface and accompanying window designations as well as relevant information about parameters and generally saving your project configuration.

7.1 Program interfaces

The following chapters include an overview of the program interfaces for the described software components.

7.1.1 DS6 program interface

Using the graphical interface of the DriveControlSuite commissioning software (DS6), you can project, parameterize and commission your drive project quickly and efficiently. In case of service, you can evaluate diagnostic information such as operating states, fault memories and fault counters of your drive project using DriveControlSuite.

Information

The program interface of DriveControlSuite is available in German, English and French. To change the language of the program interface, select **Settings > Language**.

Information

The DriveControlSuite help in the menu bar can be reached via **Help > Help for DS6** or via the [F1] key on your keyboard. When you press [F1] in an area of the program, the corresponding help topic opens.

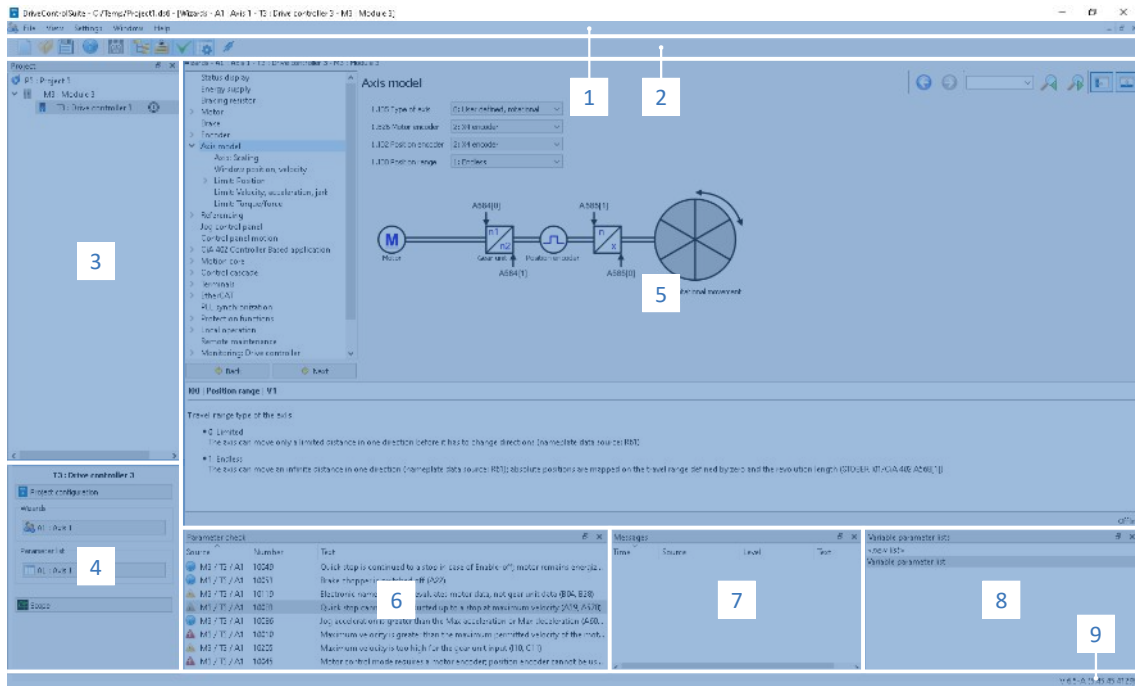

Fig. 2: DS6: Program interface





No.	Area	Description
1	Menu bar	Using the File, View, Settings and Window menus, you can open and save projects, display and hide program windows, select the interface language and access level and change between different windows in the workspace.
2	Toolbar	The toolbar enables quick access to frequently needed functions, like opening and saving projects and hiding and displaying windows in the program interface.
3	Project tree	The project tree forms the structure of your drive project in the form of modules and drive controllers. Select an element using the project tree first in order to edit it using the project menu.
4	Project menu	The project menu offers you various functions for editing the project, module and drive controller. The project menu adapts to the element that you selected in the project tree.
5	Workspace	The different windows which can be used to edit your drive project, such as the configuration dialog, wizards, the parameter list or the scope analysis tool, open in the workspace.
6	Parameter check	The parameter check points out irregularities and inconsistencies that were detected in the plausibility check of calculable parameters.
7	Messages	The entries in the messages log the connection and communication status of the drive controllers, incorrect inputs caught by the system, errors when opening a project or rule violations in the graphical programming.
8	Variable parameter lists	You can use variable parameter lists to compile any parameters in individual parameter lists for a quick overview.
9	Status bar	In the status bar, you can find the specifications of the software version and get additional information about the project file, the devices and the progress of the process during processes such as loading projects.

7.1.1.1 Configuring the view

In DriveControlSuite, you can change the visibility and arrangement of areas and windows, such as to optimize the available space in the workspace when working with smaller screens.

Showing/hiding areas

Use the icons in the toolbar or the items in the View menu to show or hide specific areas in DriveControlSuite as needed.

Icon	Item	Description
–	Reset	Resets the view to factory settings.
	Project	Shows/hides the Project window (project tree, project menu).
	Messages	Shows/hides the Messages window.
	Parameter check	Shows/hides the Parameter check window.
	Variable parameter lists	Shows/hides the Variable parameter lists window.

Arrange and group areas

You can undock and rearrange the individual areas via drag and drop. If you drag an undocked window to the edge of DriveControlSuite, you can release it there in a color-highlighted area either next to or on top of another window to redock it.

When you release the window onto another window, the two areas are merged into one window where you can use tabs to switch between the areas.

7.1.1.2 Navigation using sensitive circuit diagrams

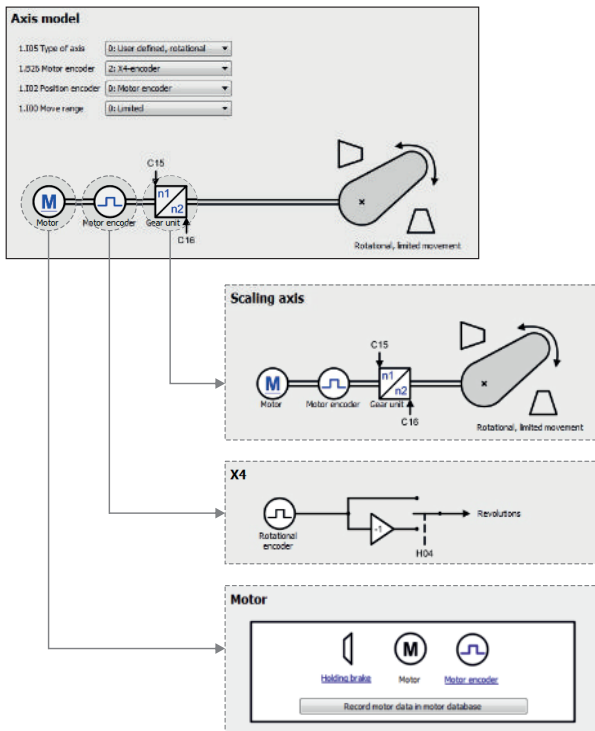

Fig. 3: DriveControlSuite: Navigation using text links and symbols

In order to graphically illustrate the processing sequence of actual and set values, the use of signals or the arrangement of drive components and to make configuring the accompanying parameters easier, they are displayed on the respective wizard pages of the workspace in the form of circuit diagrams.

Blue text links or clickable icons indicate links within the program. These refer to the corresponding wizard pages and, as a result, allow you to reach additional helpful detail pages with a click.

7.1.2 TIA Portal program interface

The Siemens Totally Integrated Automation Portal (TIA Portal) offers a platform you can use to commission your PROFINET system. The TIA Portal is broken down into the portal view and the project view.

TIA portal view

The TIA overall functionality is broken down into different task areas that you can reach using portals. The following graphic shows the interface elements of the TIA portal view relevant to this documentation.

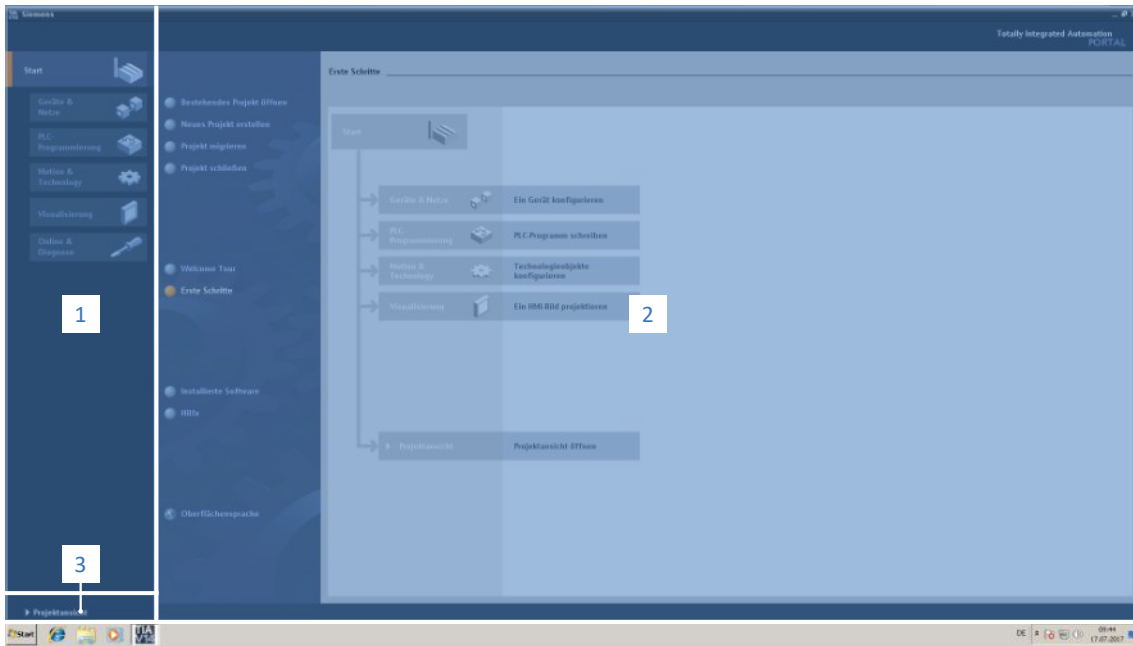

Fig. 4: TIA Portal: Program interface of the portal view

No.	Area	Description
1	Portal selection	The portal selection offers you access to various portals for different tasks and functions.
2	Portal functions	Depending on the selected portal, the portal functions are available here.
3	Project view	The button lets you change to the project view.

TIA project view

The TIA project view offers you access to all components of a project. The following graphic shows the interface elements of the TIA portal view relevant to this documentation.

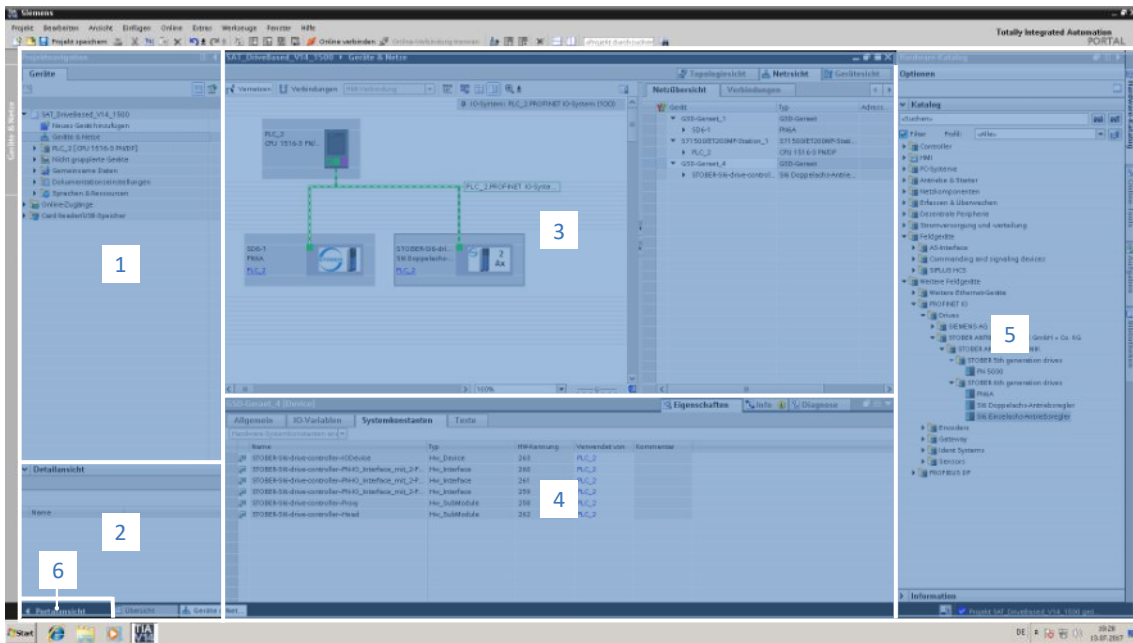

Fig. 5: TIA Portal: Program interface of the project view

No.	Area	Description
1	Project navigation	Project navigation offers you access to all components of your TIA project.
2	Details view	The details view shows you additional information about a selected object.
3	Workspace	In the workspace, you can edit objects in the topology view, network view or device view, for example.
4	Inspector window	The inspector window shows you additional information about a selected object.
5	Task cards	Task cards are available depending on the selected object and grant you access to the hardware catalog, online tools, tasks or libraries, for example.
6	Portal view	The button lets you change to the portal view.

7.2 Meaning of parameters

You can use parameters to adapt the function of the drive controller to your individual application. In addition, parameters visualize the current actual values (actual velocity, actual torque, etc.) and trigger actions such as Save values, Test phase, etc.

Interpretation of parameter identification

Parameter identification consists of the following elements, where short forms are also possible, i.e. only specifying a coordinate or the combination of coordinate and name.

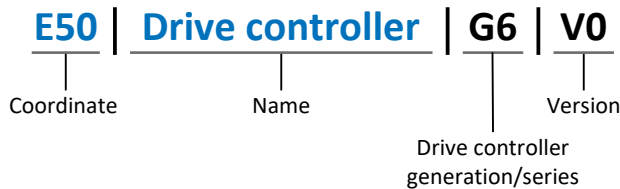

7.2.1 Parameter groups

Parameters are assigned to individual groups by topic. The drive controllers differentiate between the following parameter groups.

Group	Topic
A	Drive controllers, communication, cycle times
B	Motor
C	Machine, velocity, torque/force, comparators
D	Set value
E	Display
F	Terminals, analog and digital inputs and outputs, brake
G	Technology – Part 1 (application-dependent)
H	Encoder
I	Motion (all motion settings)
J	Motion blocks
K	Control panel
L	Technology – Part 2 (application-dependent)
M	Profiles (application-dependent)
N	Additional functions (application-dependent; e.g. extended cam control unit)
P	Customer-specific parameters (programming)
Q	Customer-specific parameters, instance-dependent (programming)
R	Production data for the drive controller, motor, brakes, motor adapter, gear unit and geared motor
S	Safety (safety technology)
T	Scope
U	Protection functions
Z	Fault counter

Tab. 3: Parameter groups

7.2.2 Parameter types and data types

In addition to topic-based sorting in individual groups, all parameters belong to a certain data type and parameter type. The data type of a parameter is displayed in the parameter list, properties table. The connections between parameter types, data types and their value range can be found in the following table.

Data type	Parameter type	Length	Value range (decimal)
INT8	Integer or selection	1 byte (signed)	-128 – 127
INT16	Integer	2 bytes (1 word, signed)	-32768 – 32767
INT32	Integer or position	4 bytes (1 double word, signed)	-2 147 483 648 – 2 147 483 647
BOOL	Binary number	1 bit (internal: LSB in 1 byte)	0, 1
BYTE	Binary number	1 byte (unsigned)	0 – 255
WORD	Binary number	2 bytes (1 word, unsigned)	0 – 65535
DWORD	Binary number or parameter address	4 bytes (1 double word, unsigned)	0 – 4 294 967 295
REAL32 (single type according to IEE754)	Floating-point number	4 bytes (1 double word, signed)	-3.40282×10^{38} – 3.40282×10^{38}
STR8	Text	8 characters	—
STR16	Text	16 characters	—
STR80	Text	80 characters	—

Tab. 4: Parameters: Data types, parameter types, possible values

Parameter types: Use

- Integer, floating-point number
For general computing processes
Example: Set and actual values
- Selection
Numeric value to which a direct meaning is assigned
Example: Sources for signals or set values
- Binary number
Bit-oriented parameter information that is collected in binary
Example: Control and status words
- Position
Integer combined with associated units and decimal places
Example: Actual and set values of positions
- Velocity, acceleration, deceleration, jerk
Floating-point number combined with associated units
Example: Actual and set values for velocity, acceleration, deceleration, jerk
- Parameter address
Referencing of a parameter
Example: In F40 AO1 source, for example, E08 n-motor filtered can be parameterized
- Text
Outputs or messages

7.2.3 Parameter types

The following types of parameters are differentiated.

Parameter type	Description	Example
Simple parameters	Consist of one group and one line with a defined value.	A21 Brake resistor R: Value = 100 ohms
Array parameters	Consist of a group, a line and multiple sequential (listed) elements, which have the same properties but different values.	A10 Access level <ul style="list-style-type: none"> A10[0] access level: Value = Access level via operating unit A10[2] access level: Value = Access level via CANopen and EtherCAT A10[4] access level: Value = Access level via PROFINET
Record parameters	Consist of a group, a line and multiple sequential (listed) elements, which can have different properties and different values.	A00 Save values <ul style="list-style-type: none"> A00[0] Start: Value = Start action A00[1] Progress: Value = Display action progress A00[2] Result: Value = Display action result

Tab. 5: Parameter types

7.2.4 Parameter structure

Every parameter has specific coordinates with the following structure.

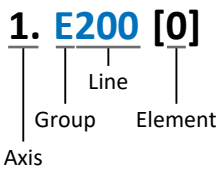

- **Axis (optional)**
Axis to which an axis-specific parameter is assigned; not applicable for global parameters (value range: 1 - 4).
- **Group**
The thematic group to which a parameter belongs (value range: A – Z).
- **Line**
Distinguishes the parameters within a parameter group (value range: 0 – 999).
- **Element (optional)**
Elements of an array or record parameter (value range: 0 – 16000).

7.2.5 Parameter visibility

The visibility of a parameter is controlled by the access level you set in DriveControlSuite and by the properties you project for the respective drive controller (e.g. hardware, firmware and application). A parameter can also be shown or hidden depending on other parameters or settings. For example, the parameters of an additional function are only shown as soon as you activate the relevant additional function.

Access level

The access options for the individual software parameters are ranked hierarchically and divided into individual levels. This means that parameters can be hidden for a specific purpose and, relatedly, their configuration options can be locked starting from a specific level.

Each parameter has one access level for read access (visibility) and one access level for write access (editability).

The following levels are present:

- Level 0
Elementary parameters
- Level 1
Important parameters of an application
- Level 2
Important parameters for service with extensive diagnostic options
- Level 3
All parameters needed for commissioning and optimizing an application

The parameter A10 Access level controls general access to parameters:

- Over the drive controller display (A10[0])
- Over CANopen or EtherCAT (A10[2])
- Over PROFINET (A10[3])

Information

It is not possible to write to or read the parameter hidden in DriveControlSuite during communication via fieldbus.

Hardware

Which parameters are available to you in DriveControlSuite is determined by which series you select in the configuration dialog for the drive controller, for example, or whether you project an option module. Basically, the only parameters that are displayed are the ones you need to parameterize the configured hardware.

For example, a drive controller can evaluate an encoder using terminal X120, provided that a corresponding terminal module has been installed. The accompanying evaluation is activated using parameter H120. However, this parameter is visible only if the terminal module was initially selected during the drive project configuration.

Firmware

Due to the further development and updating of functions for the drive controllers, new parameters and also new versions of existing parameters are continuously being implemented in DriveControlSuite and in the firmware. The parameters are displayed in the software according to the DriveControlSuite version used and the configured firmware version of the respective drive controller.

Applications

Applications generally differ in terms of functions and their control. For this reason, different parameters are available with each application.

7.3 Signal sources and process data mapping

The transmission of control signals and set values in DriveControlSuite meets the following principles.

Signal sources

Drive controllers are controlled either over a fieldbus, using mixed operation consisting of a fieldbus system and terminals or exclusively using terminals.

You can use the corresponding selection parameters, referred to as signal sources, to configure whether the control signals and set values of the application are obtained over a fieldbus or using terminals.

In case of activation over a fieldbus, parameters that are selected as data sources for control signals or set values must be part of the subsequent process data mapping. In the case of activation using terminals, the respective analog or digital inputs are specified directly.

Process data mapping

If you are working with a fieldbus system and have selected the source parameters for control signals and set values, configure the fieldbus-specific settings, e.g. the assignment of the process data channels for transmitting receive and transmit process data, as the last step.

7.4 Non-volatile memory

All project configurations, parameterizations and related changes to parameter values are in effect after transmission to the drive controller, but are only stored in volatile memory.

Saving to a drive controller

To save the configuration in non-volatile memory on a drive controller, you have the following options:

- Saving the configuration using the *Save values wizard*:
Project menu > Wizards area > Projected axis > Save values wizard: Select the Save values action
- Saving the configuration using the parameter list:
Project menu > Parameter list area > Projected axis > Group A: Drive controller > A00 Save values: Set the parameter A00[0] to the value 1: Active
- Saving the configuration using the operating unit:
Drive controller with operating unit: Press the save button for 3 s

Saving to all drive controllers within a project

To save the configuration in non-volatile memory on several drive controllers, you have the following options:

- Saving the configuration using the toolbar:
Toolbar > Save values icon: Click the Save values icon
- Saving the configuration using the Online functions window:
Project menu > Online connection button > Online functions window: Click on Save values (A00)

Information

Do not shut off the drive controller while saving. If the supply voltage to the control unit is interrupted while saving, the drive controller will start without an executable configuration the next time it is switched on. To successfully complete the saving procedure, the configuration must be stored again on the drive controller and in non-volatile memory.

8 Commissioning

The following chapters describe the commissioning of a PROFINET network, consisting of a Siemens controller and multiple STOBER drive controllers, with the help of DriveControlSuite and the Siemens TIA Portal.

We assume the following system environment **as an example** so that you can follow the individual commissioning steps better:

- Drive controllers of the SD6 series in firmware version 6.6-B or later
- DS6 commissioning software version 6.6-B or later

in combination with

- Siemens SIMATIC S7-1500 controller
- Siemens Totally Integrated Automation Portal (TIA Portal) V16 automation software

Commissioning is divided into the following steps:

1. DriveControlSuite:
Project all drive controllers in your PROFINET network (device control, application and process data), parameterize all general PROFINET settings as well as the PZD transmission, motor and axis model, then transmit your configuration to the drive controllers of your PROFINET network.
2. TIA Portal:
Next, map your actual PROFINET network in TIA Portal and configure the individual nodes. Transfer the configuration to the controller and start up your PROFINET network.

Information

Before you start commissioning your PROFINET network using DriveControlSuite and TIA Portal, you must network all nodes of your PROFINET network with each other.

8.1 DS6: Configuring the drive controller

Project and configure all drive controllers for your drive system in DriveControlSuite DS6 (see the chapter [DS6 program interface](#) [▶ 14]).

Information

The steps required for commissioning PROFINET are described based on the drive-based Drive Based application in combination with Drive Based device control.

For further information on commissioning the application, refer to the corresponding Drive Based application manual (see [Detailed information](#) [▶ 76]).

Information

Always perform the steps described below in the specified order!

Some parameters are interdependent and do not become accessible to you until you have first configured certain settings. Follow the steps in the specified sequence so that you can finish the parameterization completely.

8.1.1 Initiating the project

In order to be able to configure all drive controllers and axes of your drive system using DriveControlSuite, you must record them as part of a project.

8.1.1.1 Projecting the drive controller and axis

Create a new project and project the first drive controller along with the accompanying axis.

Information

Make sure that you project the correct series in the Drive controller tab. The projected series cannot be changed afterwards.

Creating a new project

1. Start DriveControlSuite.
2. On the start screen, click Create new project.
 - ⇒ The new project is created and the configuration dialog for the first drive controller opens.
 - ⇒ The Drive controller button is active.

Projecting the drive controller

1. Properties tab:

Establish the relationship between your circuit diagram and the drive controller to be projected in DriveControlSuite.

1.1. Reference:

Define the reference code (equipment code) of the drive controller.

1.2. Designation:

Give the drive controller a unique name.

1.3. Version:

Version your project configuration.

1.4. Description:

If necessary, save additional supporting information (e.g., the change history).

2. Drive controller tab:

Select the series and device type of the drive controller.

3. Option modules tab:

Project the option modules of the drive controller.

3.1. Communication module:

Select the PN6 communication module for the transmission of PROFINET process data.

3.2. Terminal module:

If you are controlling the drive controller via analog and digital inputs, select the corresponding terminal module.

3.3. Safety module:

If the drive controller is part of a safety circuit, select the corresponding safety module.

4. Device control tab:

Project the basic control of the drive controller.

4.1. Device control:

Select device control Drive Based.

4.2. Rx process data, Tx process data:

Select PROFINET Rx and PROFINET Tx for transmitting PROFINET process data.

Projecting the axis

1. Click Axis 1.
2. Properties tab:
Establish the relationship between your circuit diagram and the axis to be projected in DriveControlSuite.
 - 2.1. Reference:
Define the reference code (equipment code) of the axis.
 - 2.2. Designation:
Give the axis a unique name.
 - 2.3. Version:
Version your project configuration.
 - 2.4. Description:
If necessary, save additional supporting information (e.g., the change history).
3. Application tab:
Select the Drive Based application.
4. Motor tab:
Select the type of motor you operate with this axis. If you are working with motors from third-party suppliers, enter the accompanying motor data later.
5. Confirm with OK.

8.1.1.2 Configuring safety technology

If the drive controller is part of a safety circuit, you must configure the safety technology in accordance with the commissioning steps outlined in the corresponding manual in the next step (see [Detailed information \[► 76\]](#)).

8.1.1.3 Creating other drive controllers and modules

In DriveControlSuite, all drive controllers within a project are grouped using modules. If you add a new drive controller to your project, be sure to always assign it to an existing module. Group drive controllers in a module if, for example, they are located in the same control cabinet or work together to operate the same machine part.

Creating a drive controller

1. In the project tree, select your project P1 > module M1 > context menu **Create new drive controller**.
⇒ The drive controller is created in the project tree and the configuration dialog opens.
2. Project the drive controller as described in [Projecting the drive controller and axis](#).
3. Repeat the steps for all other drive controllers that you want to project.

Creating a module

1. In the project tree, select your project P1 > context menu **Create new module**.
⇒ The module is created in the project tree.
2. Project the module as described in [Projecting the module \[► 29\]](#).
3. Repeat the steps for all other modules that you want to project.

8.1.1.4 Projecting the module

Give your module a unique name, enter the reference code and, as an option, store additional information like the version and change history of the module.

1. Select the module in the project tree and click on **Project configuration** in the project menu.
 - ⇒ The configuration dialog for the module opens.
2. Establish the relationship between your circuit diagram and the module in DriveControlSuite.
 - 2.1. **Reference:**
Define the reference code (equipment code) of the module.
 - 2.2. **Designation:**
Give the module a unique name.
 - 2.3. **Version:**
Version the module.
 - 2.4. **Description:**
If necessary, save additional supporting information (e.g., the change history).
3. Confirm with **OK**.

8.1.1.5 Projecting the project

Give your project a unique name, enter the reference code and, as an option, store additional information like the version and change history of the project.

1. Select the project in the project tree and click on **Project configuration** in the project menu.
 - ⇒ The configuration dialog for the project opens.
2. Establish the relationship between your circuit diagram and the project in DriveControlSuite.
 - 2.1. **Reference:**
Define the reference code (equipment code) of the project.
 - 2.2. **Designation:**
Give the project a unique name.
 - 2.3. **Version:**
Version the project.
 - 2.4. **Description:**
If necessary, save additional supporting information (e.g., the change history).
3. Confirm with **OK**.

8.1.2 Parameterizing general PROFINET settings

- ✓ You have projected the PROFINET Rx and PROFINET Tx process data for the drive controller.
- 1. Select the relevant drive controller in the project tree and click on the desired projected axis in the Project menu > Wizard area.
- 2. Select the PROFINET wizard.
- 3. A100 Fieldbus scaling:
Leave the default value at 1: Native (values are passed unchanged).
- 4. A273 PN device name:
Elements [0] to [2] show the PROFINET device name that was assigned in TIA Portal if there is an online connection between the drive controller and controller.
In elements [3] to [5], you have the option to enter the device name. This eliminates the need to assign the device name in TIA Portal.
- 5. A109 PZD-Timeout:
Define the time that results from the tolerated failure time for monitoring the PZD communication plus the watchdog time of the controller (TIA Portal: watchdog time) in the PROFINET network (default value: 20 ms).

8.1.3 Configuring PZD transmission

The PZD channel (process data transmission channel) serves to transfer control and status information as well as actual and set values between a controller (IO controller) and drive controller (IO device) cyclically in real time.

The direction of data flow is important in this data exchange. From the perspective of the drive controller, PROFINET distinguishes between receive PZD (RxPZD) and transmit PZD (TxPZD). STOBER drive controllers support a flexible assignment of the parameter values to be transmitted.

The planned projected application determines which process data is exchanged between the controller and drive controller during cyclical data transmission.

In Drive Based applications, the process data is pre-assigned accordingly by the standard mapping. Check the standard mapping and adjust it if necessary.

For further information on the standard mapping of the Drive Based application, refer to the corresponding application manual.

Information

For fieldbus communication via PROFINET, the processing of process data in some controllers is WORD-oriented (16 bits). In Drive Based applications, the standard mapping is pre-assigned appropriately. If changes are made to the standard mapping, take the parameter data type that you are adding to or removing from the mapping into account.

If you add or remove parameters of the BYTE or INT8 data type (8 bit), this can cause problems in the data structures of the controller. If necessary, use parameter A101 Dummy byte to fill the 8-bit gaps that result in the process data and implement the necessary data structure for the controller.

8.1.3.1 Adapting RxPZD

Information

You define the scope of transmission of cyclical PZD in TIA Portal by projecting a corresponding process data module for each axis of the drive controller.

- ✓ You have projected the Drive Based application.
- 1. Select the relevant drive controller in the project tree and click on the desired projected axis in the Project menu > Wizard area.
- 2. Select the PROFINET wizard > Received process data RxPZD.
- 3. Check the standard mapping and adapt it to your requirements if necessary.
A90[0] – A90[5], A91[0] – A91[5], A92[0] – A92[5]:
Target parameters whose values are received by the drive controller from the controller. The position provides information about the receiving sequence.
- 4. Resulting data length:
Shows the overall length of the PZD to be transmitted if there is an online connection to the controller. The value must not exceed the data volume of the process data module that you project in TIA Portal (max. 72 bytes/36 words).

8.1.3.2 Adapting TxPZD

Information

You define the scope of transmission of cyclical PZD in TIA Portal by projecting a corresponding process data module for each axis of the drive controller.

- ✓ You have projected the Drive Based application.
- 1. Select the relevant drive controller in the project tree and click on the desired projected axis in the Project menu > Wizard area.
- 2. Select the PROFINET wizard > Transmitted process data TxPZD.
- 3. Check the standard mapping and adapt it to your requirements if necessary.
A94[0] – A94[5], A95[0] – A95[5], A96[0] – A96[5]:
Source parameters whose values the drive controller sends to the controller. The position provides information about the transmission sequence.
- 4. Resulting data length:
Shows the overall length of the PZD to be transmitted if there is an online connection to the controller. The value must not exceed the data volume of the process data module that you project in TIA Portal (max. 72 bytes/36 words).

8.1.4 Mapping the mechanical axis model

To be able to put your real drive train with one or more drive controllers into operation, you must map your complete mechanical environment in DriveControlSuite.

The 6th generation of STOBER drive controllers are specially developed for communication between the drive controller and controller on the basis of the actual variables at the output (° or mm of real axis movement). The scaling of the axis model is calculated by the drive controller's firmware independently of the encoder model, without any rounding errors or drift.

8.1.4.1 Parameterizing the motor

You have projected a synchronous servo motor with EnDat 2.1/2.2 digital encoder and optional brake.

By projecting the corresponding motor, limiting values for currents and torques as well as associated temperature data are automatically transferred to the respective parameters of the individual wizards. All additional data on the brake and encoder is transferred at the same time.

Motor protection

The drive controller has an i²t model of the motor, a computational model for thermal monitoring of the motor. To activate it and set up the protective function, configure the following settings (deviating from the presets): U10 = 2: Warning and U11 = 1.00 s. This model can be used instead of or in addition to temperature-monitored motor protection.

8.1.4.2 Parameterizing the axis model

Parameterize the setup of your drive in this order:

- Define the axis model
- Scale the axis
- Parameterize the position and velocity window
- Limit the axis (optional)
 - Limit the position
 - Limit the velocity, acceleration and jerk
 - Limit the torque and force

8.1.4.2.1 Define the axis model

1. Select the relevant drive controller in the project tree and click on the desired projected axis in the Project menu > Wizard area.
2. Select the Axis model wizard.
3. I05 Type of axis:
Define whether the axis type is rotational or translational.
 - 3.1. If you would like to configure the units of measure and the number of decimal places individually for specifying and displaying positions, velocities, accelerations and jerk, select 0: User defined, rotational or 1: User defined, translational.
 - 3.2. If the units of measure and the number of decimal places for specifying and displaying positions, velocities, accelerations and jerk are to be fixed, select 2: Rotational or 3: Translational.
4. B26 Motor encoder:
Define the interface to which the motor encoder is connected.
5. I02 Position encoder (optional):
Define the interface to which the position encoder is connected.
6. I00 Position range:
Define whether the travel range of the axis is limited or endless (modulo).
7. If you select I00 = 1: Endless, parameterize a revolution length when you scale the axis.

Information

When you parameterize I05 Type of axis, you can either use selection 0: User defined, rotational or 1: User defined, translational to configure units of measure and the number of decimal places for the axis model individually or use selections 2: Rotational and 3: Translational to revert to preset values.

Selection 0: User defined, rotational and selection 1: User defined, translational let you configure the unit of measure (I09) and the decimal places (I06) individually. Velocity, acceleration and jerk are represented as the derivative of the unit of measure with respect to time.

Selection 2: Rotational sets the following units of measure for the axis model: position in $^{\circ}$, velocity in rpm, acceleration in rad/s^2 , jerk in rad/s^3 .

Selection 3: Translational sets the following units of measure for the axis model: position in mm, velocity in m/s, acceleration in m/s^2 , jerk in m/s^3 .

Information

If you do not parameterize it differently for I02 Position encoder, B26 Motor encoder is used for position control as standard.

8.1.4.2.2 Scale the axis

1. Select the relevant drive controller in the project tree and click on the desired projected axis in the Project menu > Wizard area.
2. Select the Axis model wizard > Axis: Scaling.
3. Scale the axis by configuring the overall gear ratio between the motor and output.
To simplify this scaling for you, you are provided with the scaling calculator Conversion of positions, velocities, accelerations, torque/force, which calculates the effects of changed motion variables on the entire system.
4. I01 Circular length:
If you have selected 1: Endless for I00 Position range, enter the revolution length.
5. I06 Decimal places position (optional):
If you have selected 0: User defined, rotational or 1: User defined, translational for I05 Type of axis, define the desired number of decimal places.
6. I09 Measure unit (optional):
If you have selected 0: User defined, rotational or 1: User defined, translational for I05 Type of axis, define the desired unit of measure.
7. I03 Axis polarity:
Use the polarity to specify the direction of interpretation between the axis movement and motor movement.

Information

A change to parameter I06 moves the decimal separator for all axis-specific position values! Ideally, define I06 before parameterizing other position values and then check them.

If the axis receives set value specifications from a controller or follows the master values of a master, the resolution of position values directly impacts the smooth operation of the axis. Therefore, you should define a sufficient number of decimal places appropriate for your application.

Information

Parameter I297 Maximum speed position encoder must be parameterized according to your application case. If I297 is set too low, the permitted maximum speed is exceeded even at normal operating speeds. On the other hand, if I297 is set too high, measuring errors of the encoder can be overlooked.

I297 depends on the following parameters: I05 Type of axis, I06 Decimal places position, I09 Measure unit as well as I07 Distance factor numerator position and I08 Distance factor denominator position or A585 Feed constant for CiA 402. If you have made changes to one of the parameters listed, select I297 accordingly as well.

8.1.4.2.3 Parameterizing the position and velocity window

Enter position limits and velocity zones for set values. To do so, parameterize boundary values for reaching a position or velocity.

1. Select the **Axis model wizard** > **Window position, velocity**.
2. **C40 Velocity window:**
Parameterize a tolerance window for velocity tests.
3. **I22 Target window:**
Parameterize a tolerance window for position tests.
4. **I87 Actual position in window time:**
Parameterize how long a drive must stay in the specified position window before a corresponding status message is output.
5. **I21 Maximal following error:**
Parameterize a tolerance window for lag tests.

8.1.4.2.4 Limiting the axis

As an option, you can limit the maximum permitted motion variables of position, velocity, acceleration, jerk and torque/force according to your application.

Information

To simplify the scaling and limiting of the axis, the **Axis model wizard** > **Axis: Scaling** provides you with the **Conversion of position, velocities, accelerations, torque/force** scaling calculator, which calculates the effects of changed motion variables on the entire system. You can use the scaling calculator to enter values for motion variables of the motor, gear unit output and axis in order to convert the values to all other locations in the axis model.

Limiting the position

To secure the travel range of the axis, you have the option to limit the permitted positions using a software or hardware limit switch.

1. Select the relevant drive controller in the project tree and click on the desired projected axis in the **Project menu** > **Wizard area**.
2. Select the **Axis model wizard** > **Limit: Position**.
3. **I101 Source positive /limit switch, I102 Source negative /limit switch:**
To limit the travel range of the axis via hardware limit switches, select the source of the digital signal that is used to evaluate a limit switch at the positive or negative end of the travel range.
 - 3.1. If a fieldbus is the source, select **2: Parameter**.
 - 3.2. If a digital input (direct or inverted) acts as the source, select the corresponding input.
4. **I50 Software stop positive, I51 Software stop negative:**
To limit the travel range of the axis via software limit switches, define the largest or smallest permitted position for software position limiting.

Limiting velocity, acceleration, jerk

As an option, you can limit the motion variables of velocity, acceleration and jerk and define the quick stop deceleration according to your application. The default values are designed for slow velocities without gear units.

1. Select the **Motor wizard**.
2. **B83 v-max motor**:
Determine the maximum permitted velocity of the motor.
3. Select the **Axis model wizard > Axis: Scaling**.
4. **Conversion of positions, velocities, accelerations, torque/force area**:
Use the scaling calculator to determine the maximum permitted velocity of the output using the maximum permitted velocity of the motor.
5. Select the **Axis model wizard > Limit: Velocity, acceleration, jerk**.
6. **I10 Maximal speed**:
Define the maximum permitted velocity for the output.
7. **I11 Maximal acceleration**:
Define the maximum permitted acceleration for the output.
8. **I16 Maximal jerk**:
Define the maximum permitted jerk for the output.
9. **I17 Quickstop deceleration**:
Define the desired quick stop deceleration for the output.

Limiting torque/force

As an option, you can limit the torque/force according to your application. The default values take into account the rated operation together with the overload reserves.

1. Select the **Axis model wizard > Limit: Torque/force**.
2. **C03 Maximum positive torque/force, C05 Maximum negative torque/force**:
Define the maximum permitted set torque/maximum permitted set force.
3. **C08 Maximum torque/force for quick stop**:
Define the maximum permitted set torque/maximum permitted set force in case of a quick stop and in case of drive-controlled emergency stop SS1, SS1 and SS2.

8.1.5 Transmitting and saving a configuration

In order to transmit and save the configuration to one or more drive controllers, you must connect your PC and the drive controllers over the network.

WARNING!

Injury to persons and material damage due to axis movement!

If there is an online connection between DriveControlSuite and the drive controller, changes to the configuration can lead to unexpected axis movements.

- Only change the configuration if you have visual contact with the axis.
- Make sure that no people or objects are within the travel range.
- For access via remote maintenance, there must be a communication link between you and a person on site with eye contact to the axis.

Information

During the search, all drive controllers within the broadcast domain are found via IPv4 limited broadcast.

Requirements for finding a drive controller in the network:

- Network supports IPv4 limited broadcast
- All drive controllers and the PC are in the same subnet (broadcast domain)

8.1.5.1 Transmitting the configuration

The steps for transmitting the configuration vary depending on the safety technology.

Drive controller without SE6 option (advanced safety technology)

- ✓ The drive controllers are switched on and can be found in the network.
- 1. In the project tree, select the module under which you have recorded your drive controller and click **Online connection** in the project menu.
 - ⇒ The **Add connection** dialog box opens. All drive controllers found via IPv4 limited broadcast are displayed.
- 2. **Direct connection** tab, **IP address** column:
 - Activate the IP addresses in question and confirm your selection with **OK**.
 - ⇒ The **Online functions** window opens. All drive controllers connected through the selected IP addresses are displayed.
- 3. Select the module and the drive controller to which you would like to transfer the configuration. Change the selection of transmission type from **Read** to **Send**.
- 4. Change the selection **Create new drive controller**:
 - Select the configuration that you would like to transfer to the drive controller.
- 5. Repeat steps 3 and 4 for all other drive controllers to which you would like to transfer your configuration.
- 6. **Online** tab:
 - Click **Establish online connections**.
 - ⇒ The configurations are transferred to the drive controllers.

Drive controller with SE6 option (advanced safety technology)

- ✓ The drive controllers are switched on and can be found in the network.
- 1. In the project tree, select the module under which you have recorded your drive controller and click **Online connection** in the project menu.
 - ⇒ The **Add connection** dialog box opens. All drive controllers found via IPv4 limited broadcast are displayed.
- 2. **Direct connection** tab, **IP address** column:
Activate the IP addresses in question and confirm your selection with **OK**.
 - ⇒ The **Online functions** window opens. All drive controllers connected through the selected IP addresses are displayed.
- 3. Select the module and the drive controller to which you would like to transfer the configuration. Change the selection of transmission type from **Read** to **Send**.
- 4. Change the selection **Create new drive controller**:
Select the configuration that you would like to transfer to the drive controller.
- 5. Repeat steps 3 and 4 for all other drive controllers to which you would like to transfer your configuration.
- 6. **Online** tab:
Click **Establish online connections**.
 - ⇒ The configurations are transferred to the drive controllers.
 - ⇒ The **PASmotion Safety Configurator** configuration tool opens.
- 1. In the project administration, navigate from **PASmotion Safety Configurator** to the safety module for the drive controller and double-click to open it.
 - ⇒ The wizard for device synchronization opens.
 - ⇒ The project configuration and device configuration are checked against each other.
- 2. If the configurations match, click **Done** after device synchronization has finished.
- 3. Optional: If the configurations do not match, click **Next** after device synchronization has finished.
 - 3.1. Confirm the serial number of the safety module and click **Next**.
 - 3.2. Enter the password for the configuration on the safety module and click **Next**.
 - 3.3. Click **Download**.
 - ⇒ The project configuration is transferred to the safety module.
 - 3.4. After the successful transfer, click **Done**.
- 4. **Home page, CRC safety configuration**:
Document the checksum of the safety functions in the machine documentation.
- 5. Repeat the steps for each additional safety module in your project.
- 6. Exit **PASmotion Safety Configurator**.
 - ⇒ Transfer of the configuration is completed.

Information

If you do not know the password for the configuration on the safety module and would like to send a new safety configuration, you can delete the safety configuration on the safety module in **DriveControlSuite** using parameter **S33**.

8.1.5.2 Saving the configuration

- ✓ You have successfully transferred the configuration.
- 1. Online functions **window**, Online **tab**, Actions for drive controller in online operation **area**:
Click Save values (A00).
 - ⇒ The Save values (A00) **window** opens.
- 2. Select on which drive controllers you want to save the configuration.
- 3. Click Start action.
 - ⇒ The configuration is stored on the drive controllers in non-volatile memory.
- 4. Close the Save values (A00) **window**.

Information

For the configuration to take effect on the drive controller, a restart is required: for example, after the configuration is saved on the drive controller for the first time or when changes are made to the firmware or process data mapping.

Restarting a drive controller

- ✓ You have stored the configuration on the drive controller in non-volatile memory.
- 1. Online functions **window**, Online **tab**:
Click Restart (A09).
 - ⇒ The Restart (A09) **window** opens.
- 2. Select which of the connected drive controllers you want to restart.
- 3. Click Start action.
- 4. Confirm the safety note with OK.
 - ⇒ The Restart (A09) **window** closes.
- ⇒ The fieldbus communication and connection between DriveControlSuite and drive controllers are interrupted.
- ⇒ The selected drive controllers restart.

8.1.6 Testing the configuration

After you have transferred the configuration to the drive controller, first check your projected axis model and the parameterized electrical and mechanical data for plausibility before continuing with the parameterization.

You can test the configuration quickly and easily via DriveControlSuite or, as an alternative, directly via the operating unit of the drive controller. For further information, refer to the corresponding manual of the drive controller.

Information

Make sure that the values of the control panel are compatible with your projected axis model in order to obtain useful test results that you can use to optimize your configuration for the respective axis.

The scaling calculator is available under the *Axis model wizard > Axis: Scaling* to recalculate the values for the control panel according to your projected axis model.

WARNING!

Injury to persons and material damage due to axis movement!

When you activate the control panel, DriveControlSuite gives you sole control of the motions of the axis. If you are using a controller, it no longer monitors the axis movements after the control panel is activated. The controller cannot intervene to prevent collisions. The controller takes over control again when the control panel is deactivated, which can cause unexpected axis movements.

- Do not switch to other windows when the control panel is active.
- Only use the control panel if you have visual contact with the axis.
- Make sure that no people or objects are within the travel range.
- For access via remote maintenance, there must be a communication link between you and a person on site with eye contact to the axis.

Testing the configuration using the jog control panel

- ✓ There is an online connection between DriveControlSuite and the drive controller.
 - ✓ You have successfully stored the configuration on the drive controller.
 - ✓ No safety function is active.
1. Select the relevant drive controller in the project tree and click on the desired projected axis in the Project menu > Wizard area.
 2. Select the Jog control panel wizard.
 3. Click Control panel on and then Enable.
 - ⇒ The axis is monitored via the active control panel.
 4. Check the default values of the control panel and adjust them to your projected axis model if necessary.
 5. To test the configuration of your projected axis for direction of motion, velocity, etc., move the axis gradually using the Jog+, Jog-, Jog step+ and Jog step- buttons.
 6. Use your test results to optimize your configuration as necessary.
 7. To deactivate the control panel, click on Control panel off.

Information

Jog+ and Jog- cause a continual manual movement in the positive or negative direction. Jog step+ and Jog step- move the axis relative to the current actual position by the increment specified in I14.

Jog+ and Jog- have a higher priority than Jog step+ and Jog step-.

8.2 TIA Portal: Setting up a PROFINET network

A PROFINET networks generally consists of a controller (IO controller) and multiple drive controllers (IO devices). Using TIA Portal, map your real PROFINET network in a TIA project, configure all PROFINET nodes and link them logically with each other. Then, transfer the configuration to the controller and check the cyclical communication.

Information

Always perform the steps described below in the specified order!

Some parameters are interdependent and do not become accessible to you until you have first configured certain settings. Follow the steps in the specified sequence so that you can finish the parameterization completely.

8.2.1 Installing the GSD file

To be able to map the STOBER drive controllers of your PROFINET network in your TIA project, you must import and install a GSD file (general station description file) from STOBER in your TIA project. STOBER drive controllers are available in the hardware catalog of your TIA project as soon as the GSD file has been installed.

Information

If you have already downloaded a GSD file from the STOBER download area at an earlier point, make sure that you are using the current version of the GSD file required.

- ✓ You have downloaded the current version of the GSD file from the STOBER download area and saved it locally.
 - ✓ You have created a TIA project and are in the TIA project view.
1. In the menu bar, select **Options > Manage general station description files (GSD)**.
 - ⇒ The **Manage general station description files** window opens.
 2. **Installed GSDs tab > Source path area:**
Select the directory in which you have stored the GSD file from STOBER and confirm with **OK**.
 - ⇒ The GSD file is displayed in the **Content of the imported path area**.
 3. **Content of the imported path area:**
Select the desired GSD file and click on **Install**.
 - ⇒ The GSD file is installed; the STOBER drive controllers are available in the hardware catalog.

8.2.2 Projecting the PROFINET network

Map the controller and all drive controllers of your PROFINET network in a TIA project by selecting the corresponding modules from the hardware catalog and incorporating them into the project.

8.2.2.1 Projecting the controller

Project the controller of your PROFINET network.

- ✓ You have created a TIA project and installed the GSD file from STOBER.
- ✓ You are in the TIA network view; the hardware catalog is open.
- 1. Hardware catalog:
Select **Controller > SIMATIC S7-1500 > CPU** and open the folder of the CPU type that belongs to your controller.
- 2. Drag and drop the desired controller into the network view.
- ⇒ The controller is incorporated into your TIA project.

8.2.2.2 Projecting the drive controller

Project all drive controllers of your PROFINET network.

- ✓ You have created a TIA project and installed the GSD file from STOBER.
- ✓ You are in the TIA network view; the hardware catalog is open.
- 1. Hardware catalog:
Select **Other field devices > PROFINET IO > Drives > STOBER ANTRIEBSTECHNIK GmbH & Co. KG > STOBER ANTRIEBSTECHNIK > STOBER 6th generation drives > PN6A**.
- 2. Drag and drop the desired drive controller into the network view.
⇒ The drive controller is incorporated into your TIA project.
- 3. Repeat steps 1 and 2 for all drive controllers of your PROFINET network.

8.2.2.3 Linking the controller and drive controller logically

Establish a logical gate link between the controller and drive controllers in order to enable the communication between the devices.

- ✓ You have projected the controller and drive controllers.
- ✓ You are in the TIA network view.
- 1. Click on the interface of the controller and drag a connection to the interface of the first drive controller while holding the mouse button.
- 2. Repeat the process for all drive controllers of your PROFINET network.
- ⇒ The controller and drive controllers of your PROFINET network are linked logically with each other.

Information

To be able to link the controller and drive controllers with each other logically, you must be in the TIA network view.

8.2.3 Configuring network addresses

As needed, you can change the IP address and subnet mask of the controller.

- ✓ You are in the TIA network view.
- 1. Double-click on the controller of your PROFINET network.
 - ⇒ This switches you to the respective device view; the Inspector window shows the device properties.
- 2. Inspector window > General tab:
Select PROFINET interface > Ethernet addresses in the area navigation.
- 3. IP protocol area > Set IP address in the project:
If not set by default, activate this option and change the IP address and subnet mask of the controller.
- ⇒ The IP address and subnet mask of the controller are configured.

8.2.4 Configuring the drive controller

Assign a device name for the drive controllers of your TIA project to be able to identify them in the PROFINET network. Then, project the process data modules and configure the settings for PZD transmission between the controller and drive controller.

8.2.4.1 Assigning device names

Assign a device name for your drive controllers to be able to identify them in the PROFINET network.

- ✓ You are in the TIA network view.
- 1. Double-click on a drive controller of your PROFINET network.
 - ⇒ This switches you to the respective device view; the Inspector window shows the device properties.
- 2. Inspector window > General tab:
Select General in the area navigation.
- 3. Name:
Assign a device name for the drive controller that corresponds to the PROFINET naming conventions.
- 4. Device view:
Select the relevant drive controller and select Assign device name using its context menu.
 - ⇒ The Assign PROFINET device name window opens.
- 5. Click on Update list.
 - ⇒ All drive controllers are listed that were found in the subnet.
 - ⇒ Depending on the drive controller, the device type, IP address and MAC address are displayed.
- 6. Mark the drive controller that you would like to name and click on Assign name.
 - ⇒ The device name is assigned to the selected drive controller.

Information

Alternatively, you can enter the device name in DriveControlSuite in parameter A273[3] to [5]. This eliminates steps 4 to 6 in TIA Portal for assigning the device name.

Information

Using Flash LED, you can identify which drive controller you have currently selected if multiple drive controllers are found in the same subnet.

As an alternative, you can identify the drive controller by its MAC address. The MAC address of the drive controller can be read off in parameter A279 PN MAC addresses in DriveControlSuite (PROFINET wizard > Diagnostics).

8.2.4.2 Projecting the process data module

Define the data volume for the PZD transmission of the PROFINET communication by projecting a process data module for each axis.

- ✓ You are in the TIA network view; the hardware catalog is open.
- 1. Double-click on a drive controller of your PROFINET network.
 - ⇒ This switches you to the respective device view; the inspector window shows the device properties.
- 2. Hardware catalog:
Select Module > Cat 1: Process data modules (PZD), all consistent.
- 3. Select a process data module with a data volume that corresponds at least to your process data map in the drive controller.
- 4. Drag and drop the selected module into the device overview of the drive controller at slot 1 provided for this.
- 5. If you are using a double-axis controller, repeat the process for the second axis and slot 2.
 - ⇒ The input and output addresses of the drive controller are generated automatically.

8.2.4.3 Configuring PZD transmission

For the PZD transmission, configure the cycle time for the data exchange as well as the watchdog time for the monitoring of PROFINET communication between the controller and drive controller.

✓ You are in the TIA network view.

1. Double-click on a drive controller of your PROFINET network.

⇒ This switches you to the respective device view; the inspector window shows the device properties.

2. Inspector window:

In the area navigation, select PROFINET interface [X1] > Advanced options > Real-time settings > IO cycle.

3. Update time:

Configure the cycle time in which the controller and drive controller exchange data.

3.1. Calculate update time automatically:

If the cycle time is to be calculated automatically, select this option.

3.2. Set update time manually:

If you want to set the cycle time manually, select this option and specify the desired time.

3.3. Adapt update time when send clock changes:

If you have set the cycle time manually and if the ratio between cycle time and transmission cycle is to remain constant, also select this option.

4. Watchdog time area:

Configure the watchdog time for monitoring the PROFINET communication.

4.1. Accepted update cycles without IO data:

Enter the number of permitted cycles after which the PROFINET watchdog is triggered in case of an interruption in PROFINET communication.

4.2. Watchdog time:

The watchdog time for PROFINET communication is calculated automatically based on the cycle time and the permitted cycles without data exchange and must not exceed 1.92 seconds.

Information

The application-dependent cycle time of the drive controller can be read off in parameter A150 Cycle time in DriveControlSuite.

8.2.5 Transmitting the configuration

Transmit the configuration of your TIA project from your PC to your controller.

- ✓ You have fully mapped and parameterized your PROFINET network in the TIA project.
- 1. Project navigation > Devices tab:
Select the folder of the controller in question.
- 2. Select Online > Advanced download to device in the menu bar.
⇒ The Advanced download window opens.
- 3. Select target device area:
Select Show all compatible nodes and click on Start search.
⇒ All controllers are listed that were found in the subnet.
- 4. Select the controller where you would like to transfer the configuration and click on Download.
⇒ The Software synchronization before downloading to a device window opens.
- 5. Click on Continue without synchronizing.
⇒ The Preview download window opens.
- 6. Click on Download.
⇒ The configuration is transmitted to the selected controller and the Results of the download process window opens.
- 7. Click on Finish.
⇒ The download process is complete; the configuration was transmitted successfully to the controller.

Information

If there is an online connection, you can identify which controller you have currently selected using Flash LED if multiple controllers are located in the same subnet.

Information

In DriveControlSuite, parameter A271 provides information about the state of the drive controller in the PROFINET network. If the application selected in DriveControlSuite does not match the inserted module in TIA Portal, the status 6: Configuration Application / PROFINE does not fit is output there.

- In this case, make sure that the device control and the PROFIdrive application are projected in DriveControlSuite and that a PROFIdrive module has been inserted in TIA Portal.

Information

Parameter A272 in DriveControlSuite provides information about the submodules projected in TIA Portal (display format: XXX YYY ZZZ; XXX = submodule ID (telegram no.), YYY = TxPZD data length in bytes, ZZZ = RxPZD data length in bytes).

8.2.6 Testing communication

Check the communication between the controller and drive controllers of your PROFINET network using the diagnostics buffer of the controller.

✓ You have transferred the configuration to the controller.

1. Project tree > Devices tab:

Open the folder of the relevant controller.

2. Double-click Online & diagnostics.

⇒ This switches you to the respective device view.

3. Select Online access in the area navigation.

4. Online access area:

Click on Go online.

⇒ An online connection to the selected controller is being established.

5. In the area navigation, select Diagnostics > Diagnostics buffer.

6. Results area:

Check the events in the diagnostics buffer for possible errors and correct their causes if necessary.

⇒ The connection between the controller and drive controller is projected and a data exchange between the nodes in the PROFINET network is possible.

Information

If there is an online connection, you can identify which controller you have currently selected using Flash LED if multiple controllers are located in the same subnet.

Information

Setup of the PROFINET network is complete. As an option, you can continue by programming the acyclical communication services, as described in [Programming acyclical communication services \[► 63\]](#).

9 Monitoring and diagnostics

For monitoring purposes and in the event of a fault, the various monitoring and diagnostic options described below are available.

9.1 Connection monitoring

In order that the drive does not respond in an unwanted manner in the event of an interruption of the PROFINET connection (cable break, etc.), we recommend monitoring the arrival of cyclical process data.

PROFINET provides the watchdog time (TIA Portal: response monitoring time) for connection monitoring. This time, in combination with the cycle time (TIA Portal: update time), defines the IO cycle in the controller (IO controller).

The cycle time determines the interval in which data is transmitted from the controller to the drive controller in question (IO device) and vice versa. It depends on various factors, including the data volume to be transferred, and is generally calculated in TIA Portal automatically for each drive controller.

The watchdog time corresponds to the number of permitted cycles without a data transfer. In addition to the watchdog time of the controller, parameter A109 PZD-Timeout can also be activated in DriveControlSuite. At the end of the watchdog time projected for the controller, the PZD timeout also takes effect in the firmware of the drive controller.

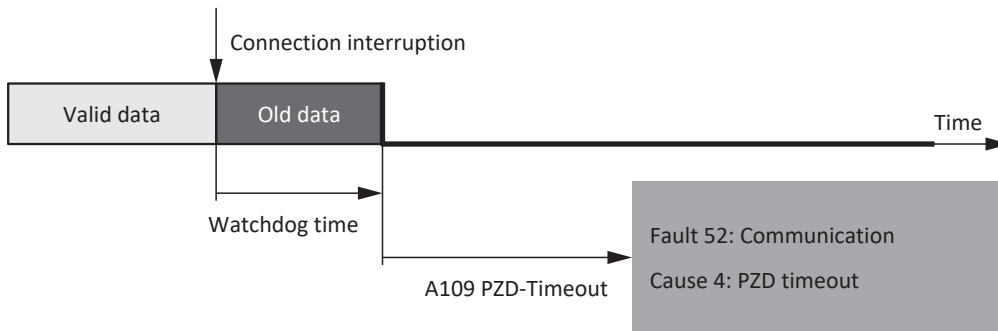

Fig. 6: PROFINET: Connection monitoring

The configured watchdog time runs down as soon as an error has occurred, and then the timeout parameterized in A109. Once the timeout has also elapsed, the drive controller changes to the **Fault** device state with the accompanying event 52: Communication, cause 4: PZD-Timeout.

9.2 LED display

The drive controllers feature diagnostic LEDs that visualize the state of fieldbus communication and the states of the physical connection.

9.2.1 PROFINET state

There are 2 LEDs on the front of the drive controller that provide information about the connection between the controller and drive controller and about the state of the data exchange. This information can also be read out in parameter A271 PN state.

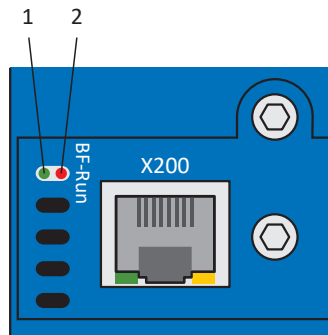

Fig. 7: LEDs for the PROFINET state

- 1 Red: BF (bus error)
- 2 Green: Run

Red LED	Conduct	Description
	Off	No error
	Rapid flashing	Data exchange with controller not active
	On	No network connection

Tab. 6: Meaning of the red LED (BF)

Green LED	Conduct	Description
	Off	No connection
	Single blink	Connection is set up to controller
	Single blink, inverse	Controller activates DHCP signal service
	Flashing	Existing connection to controller; data exchange expected
	On	Existing connection to controller

Tab. 7: Meaning of the green LED (Run)

9.2.2 PROFINET network connection

The Act. and Link LEDs at X200 and X201 on the top of the device indicate the state of the PROFINET network connection.

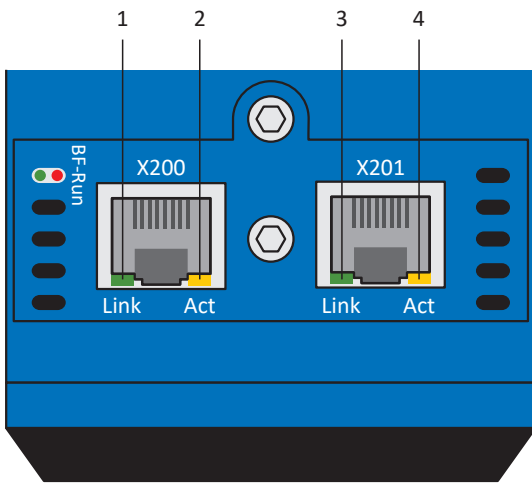





Fig. 8: LEDs for the state of the PROFINET network connection

- 1 Green: Link at X201
- 2 Yellow: Activity at X201
- 3 Green: Link at X200
- 4 Yellow: Activity at X200

Green LED	Behavior	Description
	Off	No network connection
	On	Network connection exists

Tab. 8: Meaning of the green LEDs (Link)

Yellow LED	Behavior	Description
	Off	No data exchange
	Flashing	Active data exchange with IO controller

Tab. 9: Meaning of the yellow LEDs (Act.)

9.3 Events

The drive controller has a self-monitoring system that uses test rules to protect the drive system from damage. Violating the test rules triggers a corresponding event. There is no possible way for you as the user to intervene in some events, such as the Short/ground event. In others, you can influence the effects and responses.

Possible effects include:

- **Message:** Information that can be evaluated by the controller
- **Warning:** Information that can be evaluated by the controller and becomes a fault after a defined time span has elapsed without the cause being resolved
- **Fault:** Immediate drive controller response; the power unit is disabled and axis movement is no longer controlled by the drive controller or the axis is brought to a standstill by a quick stop or emergency braking

Depending on the event, there are various measures you can take to rectify the cause. As soon as the cause has been successfully rectified, you can usually acknowledge the event immediately. If the drive controller has to be restarted, a corresponding note can be found in the measures.

ATTENTION!

Damage to property due to interruption of a quick stop or emergency braking!

If, when executing a quick stop or emergency braking, a fault occurs or STO is active, the quick stop or emergency braking is interrupted. In this case, the machine can be damaged by the uncontrolled axis movement.

Information

To make it easier for control programmers to set up the human-machine interface (HMI), a list of events and their causes can be found in the STOBER download center at <http://www.stoeber.de/en/downloads/> by searching for `Events`.

9.3.1 Event 52: Communication

The drive controller has a **fault** if:

- A29 = 0: Inactive for Drive Based device control

Response:

- The power unit is disabled and axis movement is no longer controlled by the drive controller
- The brakes are applied in the event of an inactive release override (F06)

The drive controller has a **fault with a quick stop** if:

- A29 = 1: Active for Drive Based device control

Response:

- The axis is stopped by a quick stop
- During the quick stop, the brakes remain released
- At the end of the quick stop, the power unit is disabled and axis movement is no longer controlled by the drive controller
- The brakes are applied in the event of an inactive release override (F06)

Cause		Check and action
4: PZD-Timeout	Missing process data	Check the cycle time in the controller and tolerated failure time for monitoring the PZD communication in the drive controller and correct if necessary (A109)
14: PZD parameter figure faulty	Missing mapping	Check the mapping for unmappable parameters and correct them if necessary

Tab. 10: Event 52 – Causes and actions

9.4 Parameters

The following diagnostic parameters are available for you in PROFINET communication in combination with drive controllers of the SD6 series.

9.4.1 A270 | X20x state | G6 | V0

State of the network connection (fieldbus).

- [0]: X200
 - 0: Error
 - 1: No connection
No network cable plugged in
 - 2: 10 MBit/s
Connection active; transfer rate of 10 Mbps
 - 3: 100 MBit/s
Connection active; transfer rate of 100 Mbps, half-duplex
 - 4: Link OK
Connection active; transfer rate of 100 Mbps, full-duplex
- [1]: X201
See [0]: X200

9.4.2 A271 | PN state | G6 | V0

State of the drive controller in the PROFINET network.

- 0: Offline
Hardware not ready for use
- 1: Step 1
Hardware ready for use; no connection to the IO controller
- 2: Step 2
IP address received; connection to the IO controller is set up
- 3: Phase 1
Drive controller is configured by the IO controller
- 4: Phase 2
Device start-up of IO controller and drive controller completed; process data communication is started
- 5: Cyclic data exchange
Process data communication active
- 6: Configuration Application / PROFINE does not fit
Configuration of the drive controller (projected application) and configuration of the IO controller (projected modules) is contradictory; check whether the application selected in DriveControlSuite matches the connected module in the TIA Portal.

9.4.3 A272 | PN module/submodule | G6 | V1

Display of the IDs and data lengths of the submodules in the PROFINET network (source: IO controller; display format: XXX YYY ZZZ; XXX = submodule ID (telegram no.), YYY = data length of TxPZD in bytes, ZZZ = data length of RxPZD in bytes).

- [0] – [4]: Display of submodules

The assignment of elements results from the drive controller type and the configuration in the controller. There is no fixed assignment of submodules to parameter elements. For single-axis controllers, only element [0] is usually described, since a slot for a submodule is provided on the controller side for single-axis controllers. For double-axis controllers with two slots, elements [0] and [1] are usually described. If the drive controller is equipped with the SU6 safety module for PROFIsafe, the following element contains the information on the safety module. In the PROFIdrive application, a second submodule for an additional telegram can be configured for each axis. This is displayed after the submodule for the telegram.

Example of double-axis controller with PROFIdrive application and PROFIsafe safety module:

- [0]: Telegram of axis A
- [1]: Additional telegram of axis A
- [2]: Telegram of axis B
- [3]: Additional telegram of axis B
- [4]: PROFIsafe
- [0]: Single-axis controller, double-axis controller axis A
- [1]: Double-axis controller axis B

9.4.4 A273 | PN device name | G6 | V0

Device name of the drive controller (IO device) in the PROFINET network (source: IO controller).

- [0] – [2]: Current device name; parts 1 – 3 (additional use: DriveControlSuite connection dialog)
- [3] – [5]: Device name after the next fieldbus restart; parts 1 – 3

9.4.5 A274 | PN IP address | G6 | V0

IP address of the drive controller in the PROFINET network (source: IO controller).

- [0]: Current IP address
- [1]: IP address after the next fieldbus restart

9.4.6 A275 | PN subnet mask | G6 | V0

Subnet mask of the drive controller in the PROFINET network (source: IO controller).

- [0]: Current subnet mask
- [1]: Subnet mask after the next fieldbus restart

9.4.7 A276 | PN gateway | G6 | V0

Gateway address of the drive controller in the PROFINET network (source: IO controller).

- [0]: Current gateway address
- [1]: Gateway address after the next fieldbus restart

9.4.8 A279 | PN MAC addresses | G6 | V0

MAC addresses of the drive controller in the PROFINET network.

- [0]: PROFINET device
- [1]: X200
- [2]: X201

10 More on PROFINET?

The following chapters summarize the key terms, services and relationships relating to PROFINET.

10.1 PROFINET

PROFINET (process field network) is the open industrial Ethernet standard for automation from Siemens, developed in collaboration with the PROFIBUS-Nutzerorganisation e. V. PROFINET is standardized in IEC 61158 and IEC 61784.

PROFINET is based on Ethernet TCP/IP and is primarily used in cases where fast data communication over Ethernet networks combined with industrial IT functions are needed.

PROFINET transfers process data (PZD), data for parameterization (parameter channel data), data for diagnostic purposes, alarms and IT applications – all over a single network.

PROFINET transmits data with and without a real-time request, while process data and alarms are exclusively transferred using the real-time communication. PROFINET provides two versions in order to scale this optimally: PROFINET RT for unsynchronized communication and PROFINET IRT for cycle-synchronized real-time communication.

PROFINET follows the provider-consumer model where communication partners are on equal footing. Data can be sent without a request from another network node. Normally, in the case of a data exchange, a controller (IO controller) reads in the signals from the drive controllers (IO devices), processes them and provides them back to the drive controllers.

10.2 Device classes

PROFINET classifies network nodes into the following device classes based on their tasks.

IO supervisor (PC)

An IO supervisor is typically a piece of engineering and diagnostics software that can access all process and configuration data and process alarms or diagnostic messages. The supervisor is normally only integrated into the network on a temporary basis.

IO controller (controller)

An IO controller controls data communication, i.e. it receives process data and event-controlled messages and processes them. A programmable logic controller (PLC, e.g. SIMATIC S7-1500) normally handles the role of the IO controller.

IO device (drive controller)

An IO device is typically a decentrally located field device (e.g. a drive controller) that is assigned to at least one IO controller.

An IO device transmits process and configuration data as well as alarms. It normally consists of modules that contain the individual input and output signals of the respective process.

10.3 Communication

A controller (IO controller) controls and regulates communication with drive controllers (IO devices) in the PROFINET network. In the process, the controller transmits cyclical process data (PZD), such as control commands, to the drive controllers and receives current status information from them.

In addition, the controller and drive controller acyclically exchange data that is not time-critical, such as configuration parameter values or one-time events, using parameter channel data.

Both communication services run in parallel, with transmission of cyclical PZD having higher priority. In each cyclical exchange of data, an acyclical frame is injected as needed.

Information

It is not possible to write to or read the parameter hidden in DriveControlSuite during communication via fieldbus.

10.3.1 Cyclical communication: Process data

Process data (PZD) is normally data that is required for controlling and observing the ongoing process, such as set positions, travel velocities or acceleration information.

It is generally used for data exchange in real time. It also gives you simultaneous access to multiple drive parameters. Process data is exchanged quickly and cyclically with a high priority over the RT real-time channel.

For PROFINET, the cyclical data traffic relies directly on the MAC address of a device and does not contain any IP addresses. This keeps the overall length of a data packet relatively small.

The direction of data flow is of critical importance in this data transfer. From the perspective of the respective nodes, a distinction is made between receive PZD (RxPZD) and transmit PZD (TxPZD).

The specific communication elements that are sent and received in specific PZD can be configured for the specific manufacturer. The length and structure of the process data are defined as part of the project configuration in TIA Portal by means of the process data modules (see the chapter [Process data modules \[▶ 75\]](#)).

Currently, per drive controller, 18 parameter values with a maximum total length of 72 bytes (36 words) can be exchanged between the controller and drive controller.

For further information on scaling the process data, see [Fieldbus scaling \[▶ 69\]](#).

10.3.2 Acyclical communication: Parameter channel data

Information

If you use the example project provided by STOBER for programming acyclical communication services, this chapter is not relevant in practice.

The parameter channel is used to transfer data that is not time-critical. Parameter channel data enables read and write access to the configuration parameters of a drive controller and transfers one-time events.

Parameter channel data is transmitted acyclically in ongoing cyclical PROFINET operation, without impairing PZD communication. This requires drive-specific acyclical communication services. You can either program them based on the RDREC and WRREC SIMATIC system function blocks (see the following chapters) or load a STOBER-specific example project specifically tailored to the STOBER drive controllers from the STOBER download area in your TIA Portal and parameterize the parameters appropriately for your system environment.

10.3.2.1 RDREC and WRREC: Input and output parameters

In order to transfer acyclical parameter channel data, PROFINET offers the **Read record** and **Write record** functions. The associated interfaces are controlled using the RDREC (read record) and WRREC (write record) SIMANTIC system function blocks that operate asynchronously.

RDREC and WRREC contain special input and output parameters in a defined sequence. Both blocks communicate with the IO devices in the network using the input and output parameters described below.

RDREC: Input and output parameters

The RDREC block reads a RECORD out of a hardware component addressed in the ID parameter.

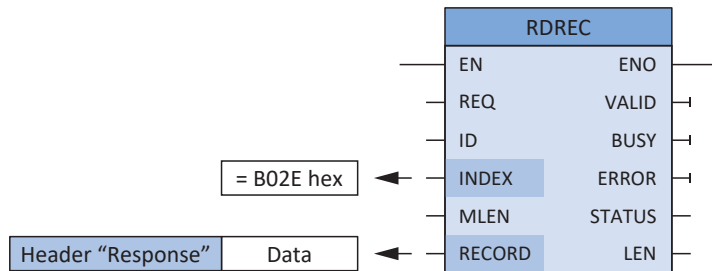

Fig. 9: RDREC system function block: Input and output parameters

Parameters	Data type	Declaration	
EN	BOOL	IN	Release input
REQ	BOOL	IN	Transfer record (REQ = 1: Start transfer)
ID	HW_IO	IN	Hardware identifier for an IO device; is issued automatically and can be read out in the device properties (System constants tab), for example
INDEX	DINT	IN	Record number (the associated value must always be B02E hex)
MLEN	UINT	IN	Maximum length of the record to be transferred
ENO	BOOL	OUT	Release output
VALID	BOOL	OUT	Record was received and is valid
BUSY	BOOL	OUT	Status of the reading (BUSY = 1: still not finished)
ERROR	BOOL	OUT	Status of the reading (ERROR = 1: faulty)
STATUS	DWORD	OUT	Status of the RDREC block or error information
LEN	UINT	OUT	Length of the record that was read
RECORD	Variant	IN/OUT	Record (consisting of header + data, see the chapter RDREC, WRREC: RECORD [▶ 71])

Tab. 11: Parameters of the RDREC system function block

WRREC: Input and output parameters

The WRREC system function block transfers the RECORD to a hardware component addressed in the ID parameter.

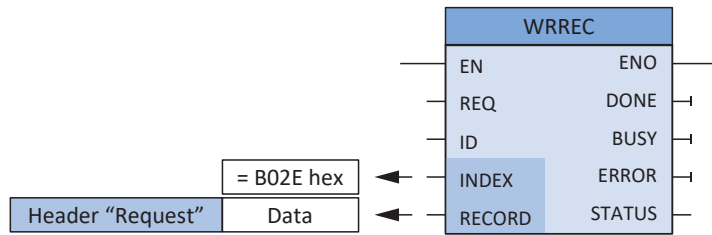

Fig. 10: WRREC system function block: Input and output parameters

Parameters	Data type	Declaration	
EN	BOOL	IN	Release input
REQ	BOOL	IN	Transfer record (REQ = 1: Start transfer)
ID	HW_IO	IN	Hardware ID for an IO device; is issued automatically and can be read out using TIA Hardware Manager > Device > Properties, for example
INDEX	DINT	IN	Record number (the associated value must always be B02E hex)
ENO	BOOL	OUT	Release output
DONE	BOOL	OUT	Status of the communication: Record was transferred
BUSY	BOOL	OUT	Status of the writing (BUSY = 1: still not finished)
ERROR	BOOL	OUT	Status of the writing (ERROR = 1: faulty)
STATUS	DWORD	OUT	Status of the WRREC block or error information
RECORD	Variant	IN/OUT	Record (consisting of header + data, see the chapter RDREC , WRREC: RECORD [▶ 71])

Tab. 12: Parameters of the WRREC system function block

10.3.2.2 RDREC and WRREC: Acyclical communication flow

The following diagrams clarify the communication flow of the RDREC and WRREC system function blocks.

Read record flow

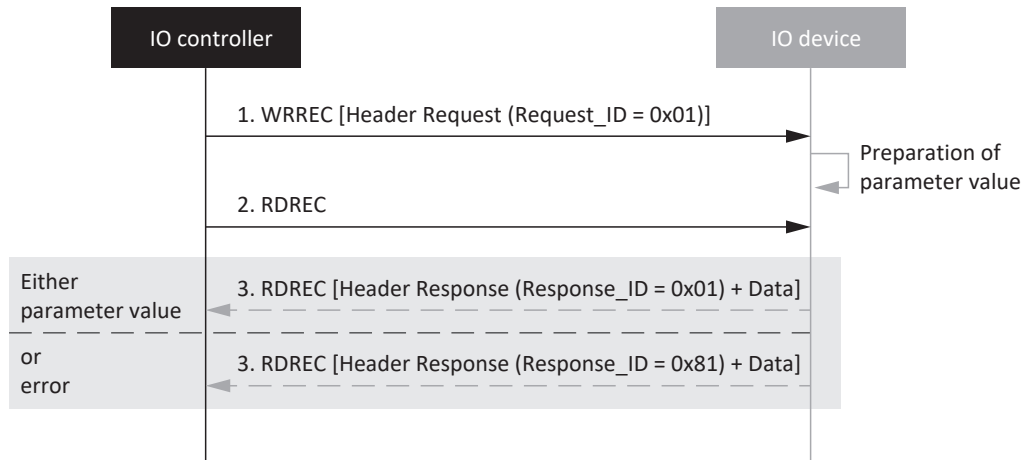

Fig. 11: RDREC flow

During RDREC, be aware that each parameter service begins with a read record request and ends with a read record response.

Write record flow

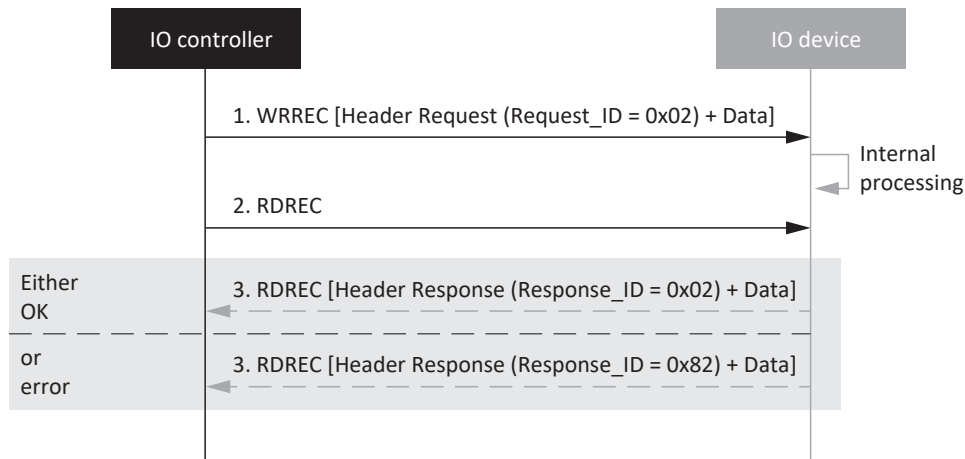

Fig. 12: WRREC flow

10.3.3 Programming acyclical communication services

To be able to transfer parameters acyclically, PROFINET provides the **Read record** and **Write record** services.

The services are controlled using SIMATIC function blocks RDREC and WRREC. You can either integrate this into the PLC program yourself or load and parameterize one of the example projects provided for download by STOBER in the TIA Portal.

Information

In the context of the latter, observe the documentation belonging to the example projects.

1. To get the latest project version, switch to the download area on the STOBER website <http://www.stoeber.de/en/downloads/> and enter the term `TIA Portal` in the search field.
 - ⇒ The TIA Portal Parameter Services (examples for generation 6) project is displayed in the result list.
2. Start the download and save the file to your PC.
3. Unpack the ZIP file.
 - ⇒ The ZIP file contains a ZAP15_1 file (SAT_Param_Example_V15_1500) for the SIMATIC S7-1500 controller from Siemens.
4. TIA Portal:
Select `Project > Retrieve` and navigate to the directory where you saved the example project.
5. Open the example project.
 - ⇒ The example project is loaded in the TIA project view.
6. Project tree > Devices tab:
Open the folder of the controller > Program blocks
7. `G6_Read_Acyclic` and `G6_Write_Acyclic` function blocks:
Parameterize the blocks as described in the documentation of the example project.

Information

Note that only one acyclic access per device may be active at the same time! When using the services in combination with internal function blocks, access coordination must be resolved in the application.

In the example project provided by STOBER, the `xLockAcyclic` bit coordinates simultaneous acyclical access to a drive controller. The bit locks the communication for other blocks. Every block that acyclically accesses a drive controller locks access using the `xLockAcyclic` bit and enables it again by resetting the bit as soon as the data exchange has ended.

10.4 Communication protocols

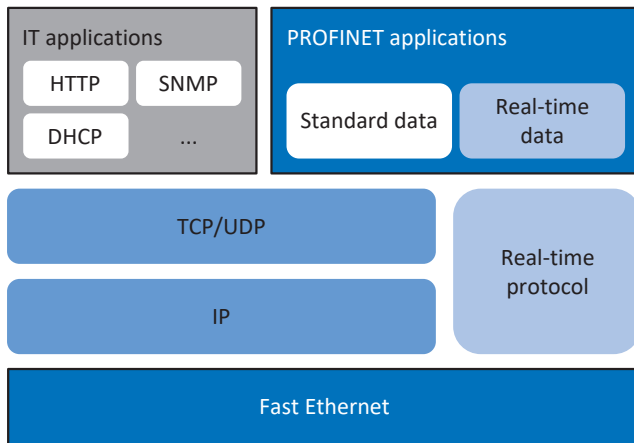

Fig. 13: PROFINET communication protocols

One protocol optimized for fast Ethernet is suitable for real-time communication: the real-time protocol. It allows for a high-performance transfer of cyclical real-time data and event-driven messages.

Standard PROFINET data without a real-time request, such as parameter values or diagnostic data, is usually transferred using the TCP/IP or UDP/IP protocols. For typical IT applications such as the transfer of websites, e-mails, etc., PROFINET relies on standard IT protocols such as HTTP or SNMP.

10.5 Ethernet network addressing

All nodes in the PROFINET network are based on the Industrial Ethernet Standard, meaning that the assignment of the following addresses and names is important to be able to communicate with drive controllers in the PROFINET IO system.

10.5.1 MAC address

Each network interface of a device in an Ethernet network requires its own address – a MAC address. The MAC address is used as a source and destination address for cyclical data exchange.

A MAC address consists of a fixed and a variable part. The fixed part identifies the manufacturer (3 bytes) and the variable part distinguishes the individual Ethernet nodes and must be globally unique (also 3 bytes). A MAC address can only communicate between two nodes of the same subnet.

The MAC addresses of the interfaces are issued by STOBER and cannot be changed.

Information

The MAC address range of the STOBER hardware is: 00:11:39:00:00:00 – 00:11:39:FF:FF:FF

You can read out the MAC address of the PROFINET interface using parameter A279 PN MAC addresses.

10.5.2 IP address

Each PROFINET node has to support various Ethernet-based protocols, at least TCP/IP and UDP/IP.

All data packets sent over the IP protocol contain the respective recipient and sender addresses. Consequently, each PROFINET node needs a unique IP address to be able to receive communication.

The IP protocol is hardware-independent; unlike the fixed MAC address, the IP address is explicitly assigned to each drive controller.

The IP address is for acyclical data exchange, e.g. transferring the configuration to the controller, configuring the drive controllers and reading out device and diagnostic information.

An IPv4 address consists of 4 decimal numbers from the value range 0 – 255 separated by a decimal.

Read out the IP address of a drive controller using parameter A274 PN IP address.

10.5.3 Subnet mask

An IP address always consists of a network ID (for identifying the network) and a host ID (for identifying the node). A subnet mask defines which parts of the IP address are assigned to the network ID. It has the structure of the IP address but only marks the network ID.

Read out the subnet mask using the A275 PN subnet mask parameter.

10.5.4 Subnets and gateways

The IP addresses of a network are usually subdivided into subnets. The purpose of subnets is to provide autonomous networks with an address range. All PROFINET nodes connected by switches are in a subnet, meaning that they communicate over a direct path. All nodes of a subnet have the same subnet mask.

Gateways are components of a subnet and are responsible for forwarding subnet-specific network queries to other subnets.

Information
<p>Be aware that real-time communication is only possible within a subnet due to addressing with MAC addresses. It is not possible to use routers for real-time communication via PROFINET.</p>

10.5.5 MAC and IP addressing using device names

To be able to provide unique identification of a drive controller (IO device) in a PROFINET IO system, it must have a symbolic device name that is unique in the system. It is assigned during the project planning phase in TIA Portal and then transferred to the drive controllers. The device name is used for parameterizing the individual drive controllers during system start-up and assigning the respective MAC and IP addresses, the latter using DCP or DHCP.

Observe the following conventions when specifying device names:

- The device name must be limited to a maximum of 240 characters. Letters, numbers, periods and dashes are permitted.
- A name component, i.e. a character string between 2 periods, may be a maximum of 63 characters long.
- Special characters like umlauts, brackets, question marks, slashes, spaces, etc. are not allowed.
- The device name may not begin with numbers.
- The device name may neither begin nor end with a minus sign (-) or a period (.).
- The device name may not take the form n.n.n.n (n = 0 – 999).
- The device name may not begin with the character sequence **port-xyz-** (x, y, z = 0 – 9).
- Underscores (_) are not allowed.

10.6 Cycle times

Possible cycle times can be found in the following table.

Type	Cycle times	Relevant parameters
PROFINET RT fieldbus, cyclical communication	1 ms, 2 ms, 4 ms, 8 ms	Adjustable in the TIA Portal

Tab. 13: Cycle times

10.7 Activating and executing actions

To be able to activate and execute actions via fieldbus, you must first enable action activation in DriveControlSuite and extend the process data by the control byte and status word for actions.

Enabling action activation

1. Select the relevant drive controller in the project tree and click on the desired projected axis in the Project menu > Wizard area.
2. Select the Drive Based application wizard > Additional functions.
3. Enable the Action activation option.

Adjusting receive process data

1. Select the relevant drive controller in the project tree and click on the desired projected axis in the Project menu > Wizard area.
2. Select the PROFINET wizard > Received process data RxPZD.
3. A90[0] – A90[5], A91[0] – A91[5], A92[0] – A92[5]:
Add A75, the control byte for activating actions, to the receive process data.

Adjusting transmit process data

1. Select the relevant drive controller in the project tree and click on the desired projected axis in the Project menu > Wizard area.
2. Select the PROFINET wizard > Transmitted process data TxPZD.
3. A94[0] – A94[5], A95[0] – A95[5], A96[0] – A96[5]:
Add A69, the status word for activating actions, to the transmit process data.

Executing an action

Then execute the desired action. Here, take into account any prerequisites with regard to the device state as well as any further measures required after the start of the action. All prerequisites as well as more detailed information on the individual actions can be found in the corresponding parameter descriptions in DriveControlSuite.

Selecting an action	Establishing the device state	Starting an action	Executing the next step	Completing an action (by progress = 100%)
0001 bin = Save values (A00)	—	Execute (A75, bit 0 =1)	—	Undo execute (A75, bit 0 = 0)
0011 bin = Reset memorized values (A37)				
0111 bin = Clear reference (I38)				
1000 bin = Delete limit switch memory (I52)				
0010 bin = Restart (A09)	E48 ≠ 4: Enabled + E48 ≠ 7: Quick stop	Execute (A75, bit 0 =1)	—	Undo execute (A75, bit 0 = 0)
1101 bin = Test winding (B43)	E48 = 2: Ready for switch-on	Execute (A75, bit 0 =1)	—	Undo execute (A75, bit 0 = 0)
1010 bin = Test phase (B40)	E48 = 2: Ready for switch-on	Execute (A75, bit 0 =1)	Enable drive controller (E48 = 4: Enabled)	Undo execute (A75, bit 0 = 0) + Undo enable
1011 bin = Calibrate motor (B41)				
1100 bin = Optimize current controller (B42)				
1110 bin = Optimize current controller (standstill) (B49)				
0100 bin = Test brake (B300)				
0101 bin = Grind brake (B301)				
0110 bin = Brake 2 grind (B302)				
1001 bin = Test brake (S18)				

Tab. 14: Selecting and executing an action

10.8 Fieldbus scaling

Use parameter A100 in the DriveControlSuite commissioning software to define the scaling for the cyclical transmission of process data in the PROFINET network. The values are either converted and represented as an integer or transmitted as a raw value without scaling according to their data types. The acyclical transmission of the parameter channel data is defined by the attributes of the parameter channel (see [Attribute and format elements: Possible combinations \[▶ 74\]](#)). The values are also either transmitted as an integer or without scaling.

Regardless of the selected settings or attributes in parameter A100, the configuration as well as the firmware both work exclusively with raw values. The following graphic shows an overview of fieldbus scaling.

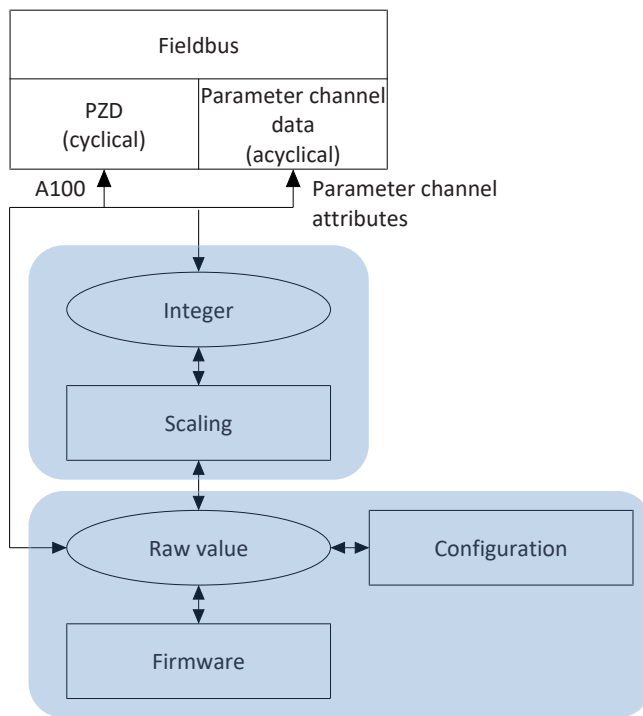

Fig. 14: Overview of fieldbus scaling

For transmission as an integer, the number of decimal places can be defined for all parameters that affect positions, velocities, accelerations, decelerations and jerk. For all other parameters, the number of decimal places is fixed. The values for scaling are output in DriveControlSuite with the properties of a parameter. The following table lists the parameters which you can use to define the number of decimal places for scaled transmission.

Scaling	Axis model	Master axis model
Position	I06	G46
Velocity	I66	G66
Acceleration, deceleration, jerk	I67	G67

Tab. 15: Fieldbus scaling for integer: Parameters for defining the decimal places

11 Appendix

11.1 Addressing parameters for RECORD record

To be able to address a parameter via fieldbus, you need its Axis_number, Parameter_number and subindex. These are calculated from the STOBER parameter coordinates (axis, group, line, element).

For basic information on the parameters, see [Meaning of parameters \[▶ 20\]](#).

11.1.1 Determining the Axis_number

The Axis_number corresponds to the axis of the parameter.

11.1.2 Calculating the Parameter_number

Information

Note that the Parameter_number in the RECORD record must be specified in hexadecimal form.

The Parameter_number is calculated from the group and line of the parameter according to the following formula:

$$\text{Parameter_number decimal} = 8192 + (\text{number of the group} \times 512) + \text{number of the line}$$

Calculation example for parameter E200 (number of the group = 4 , number of the line = 200):

$$\text{Parameter_number E200} = 8192 + (4 \times 512) + 200 = 10440 = 28C8 \text{ hex}$$

Group	Number	Addressable parameters
A: Drive controller	0	A00 – A511
B: Motor	1	B00 – B511
C: Machine	2	C00 – C511
D: Target value	3	D00 – D511
E: Display	4	E00 – E511
F: Terminals	5	F00 – F511
G: Technology	6	G00 – G511
H: Encoder	7	H00 – H511
I: Motion	8	I00 – I511
J: Motion blocks	9	J00 – J511
K: Control panel	10	K00 – K511
M: Profile	12	M00 – M511
P: Customer-specific parameters	15	P00 – P511
Q: Customer-specific parameters, instance-dependent	16	Q00 – Q511
R: Production data	17	R00 – R511
S: Safety	18	S00 – S511
T: Scope	19	T00 – T511
U: Safety functions	20	U00 – U511
Z: Fault counter	25	Z00 – Z511

Tab. 16: Groups and parameters

11.1.3 Determining the subindex

The subindex corresponds to the element of the array or record parameter. The subindex of simple parameters is 0.

11.2 RDREC, WRREC: RECORD

11.2.1 WRREC: RECORD request: Header structure

Parameter values are generally transferred using the RECORD header. For a RECORD request, the header consists of the following elements in the specified sequence.

Element	Data type	Value, value range	
Request_reference	BYTE	0 hex – FF hex	Freely selectable request number
Request_ID	BYTE	1 hex	Read request
		2 hex	Write request
		All other values	Reserved
Axis_number	BYTE	0 – 3	Addressing the axis
Number_of_parameters	BYTE	1	Number of parameters to be processed
		All other values	Reserved
Attributes	BYTE	10 hex	Access type: Value
		80 hex	Access type: Raw value
		81 hex	Access type: Integer
		82 hex	Access type: Floating point
Number_of_elements	BYTE	1 – 32 hex	1 – 50 Parameters are to be written or read
Parameter_number	WORD	2000 hex – 5FFF hex	Group and line of a parameter
Subindex	WORD	0 – 3E80 hex	Element of an array and record parameter; in single parameters, the value = 0
Format (Condition: Request_ID = 2 hex)	BYTE	8 hex	Transfer format: FLOAT
		41 hex	Transfer format: BYTE
		42 hex	Transfer format: WORD
		43 hex	Transfer format: DWORD
		1C hex, 1D hex, 1E hex	Transfer format: STRING with 8, 16 or 80 characters
Number_of_values (Condition: Request_ID = 2 hex)	BYTE	1 – 50	Number of values to be processed; value = 1 (in a simple parameter) or value = value of Number_of_elements; since a RECORD request may not exceed a length of 240 bytes, it is not always possible – depending on the respective format – to transfer max. 50 elements
1st value (Condition: Request_ID = 2 hex)	DINT	1st parameter value	Value in a simple parameter
2nd value – 50th value (Condition: Request_ID = 2 hex)	DINT	1 – 32 hex	Value = Value of Number_of_elements

Tab. 17: WRREC: RECORD request: Header structure

11.2.2 RDREC: RECORD response: Header structure

Parameter values are generally transferred using the RECORD header. For a RECORD response, the header consists of the following elements in the specified sequence.

Element	Data type	Value, value range	
Response_reference	BYTE	0 hex – FF hex	Value = Request number of RECORD request
Response_ID	BYTE	1 hex	Positive answer to a read request
		2 hex	Positive answer to a write request
		81 hex	Negative answer to a read request
		82 hex	Negative answer to a write request
Axis_number	BYTE	0 – 3	Addressing the axis
Number_of_parameters	BYTE	1	Number of parameters to be processed
Format	BYTE	8 hex	Transfer format: FLOAT
		41 hex	Transfer format: BYTE
		42 hex	Transfer format: WORD
		43 hex	Transfer format: DWORD
		1C hex, 1D hex, 1E hex	Transfer format: STRING with 8, 16 or 80 characters
		44 hex	Error in case of error
Number_of_values	BYTE	1	Number of values to be processed
1st value or error code	DINT	1st parameter value	Value in a simple parameter
	WORD		Error code in case of error (see table RDREC, WRREC: Error codes [▶ 73])
2nd value – 50th value	DINT	1 – 32 hex	Value = Value of Number_of_elements

Tab. 18: RDREC: RECORD response: Header structure

11.2.3 RDREC, WRREC: Error codes

The following table shows the possible error codes for the RDREC and WRREC system function blocks.

Error code	Cause
0 hex	Parameter unfamiliar or configuration stopped
1 hex	Access to read-only parameter
2 hex	Access to parameter with value outside the limit
3 hex	Access to unavailable subindex (array parameter)
B hex	User level not reached
11 hex	Parameter may not be changed in the current device state; deactivate release
14 hex	Invalid value within maximum limits; only occurs in the case of selection parameters with a broken definition range
16 hex	One or more incorrect values in the attribute, Number_of_elements, Parameter_number and subindex elements
17 hex	Invalid format specification
18 hex	Contrary value in the Number_of_elements and Number_of_values elements
21 hex	Invalid Request_ID = Service not supported; applies to errors in the header of the request block
A5 hex	Error cannot be specified in more detail
B0 hex	Parameter service currently not possible or valid parameter description not present
B2 hex	Unfamiliar parameter address (parameter or element does not exist)
B3 hex	Read/write access not possible for specified parameter address
B9 hex	Parameter service: Value in definition gap (observe ENUM list)
BA hex	Parameter service: Clash with other values
C0 hex	Parameter service: Error in pre-read function
C1 hex	Parameter service: Error in post-write function; value has already been received

Tab. 19: RDREC, WRREC: Error codes

11.2.4 Attribute and format elements: Possible combinations

The **attribute** element describes the access to a parameter structure (e.g. to values, descriptive texts, etc.); the **format** element describes the transfer format of a parameter. The values of both elements can be combined as follows.

Attribute	Format				
	FLOAT (8 hex)	BYTE (41 hex)	WORD (42 hex)	DWORD (43 hex)	STRING (1C hex, 1D hex, 1E hex)
Value (10 hex)	Not permitted	Not permitted	Not permitted	Scaled value for all parameters represented as integer (4 bytes)	8, 16 or 80 characters
Raw value (80 hex)	Unscaled raw value, specifically for FLOAT data type (4 bytes)	Unscaled raw value, specifically for BOOL, WORD, I8 data types (1 byte)	Unscaled raw value, specifically for WORD, I16 data types (2 bytes)	Unscaled raw value, specifically for DWORD, I32 data types (4 bytes)	Not permitted
Integer (81 hex)	Not permitted	Not permitted	Not permitted	Scaled value for all parameters represented as integer (4 bytes)	Not permitted
Floating point (82 hex)	Scaled representation for all parameters as floating point (4 bytes)	Not permitted	Not permitted	Not permitted	Not permitted

Tab. 20: Attribute, format: Possible combinations

11.3 Process data modules

Process data modules determine the data volume for the PZD transmission. During configuration in TIA Portal, one of the following process data modules must be configured for each axis of the drive controller. When creating a new project, we recommend the **all consistent** transfer type.

Module	Input data [byte]	Output data [byte]	Transfer
M101 02W PZD all cons.	4	4	2 words (inputs, outputs), all consistent*
M102 04W PZD all cons.	8	8	4 words (inputs, outputs), all consistent
M103 06W PZD all cons.	12	12	6 words (inputs, outputs), all consistent
M104 12W PZD all cons.	24	24	12 words (inputs, outputs), all consistent
M105 18W PZD all cons.	36	36	18 words (inputs, outputs), all consistent
M106 24W PZD all cons.	48	48	24 words (inputs, outputs), all consistent
M107 36W PZD all cons.	72	72	36 words (inputs, outputs), all consistent
M111 02W PZD Item cons.	4	4	2 words (inputs, outputs), Items consistent**
M112 04W PZD Item cons.	8	8	4 words (inputs, outputs), Items consistent
M113 06W PZD Item cons.	12	12	6 words (inputs, outputs), Items consistent
M114 12W PZD Item cons.	24	24	12 words (inputs, outputs), Items consistent
M115 18W PZD Item cons.	36	36	18 words (inputs, outputs), Items consistent
M116 24W PZD Item cons.	48	48	24 words (inputs, outputs), Items consistent
M117 36W PZD Item cons.	72	72	36 words (inputs, outputs), Items consistent

Tab. 21: Process data modules

*) all consistent: Process data packet is processed once the packet has been fully received

**) Items consistent: Individual parameters of the packet are processed once the parameter has been fully received

11.4 Detailed information

The documentation listed below provides you with further relevant information on the 6th STOBER drive controller generation. The current status of the documentation can be found in our download center at:

<http://www.stoeber.de/en/downloads/>.

Enter the ID of the documentation in the search field.

Title	Documentation	Contents	ID
SD6 drive controller	Manual	System design, technical data, project configuration, storage, installation, connection, commissioning, operation, service, diagnostics	442426
Drive Based application (DB) – SD6	Manual	Project configuration, configuration, parameterization, function test, detailed information	442706

Additional information and sources that form the basis of this documentation or are referenced by the documentation:

Information concerning PROFINET

You can find general information on PROFINET on the PROFIBUS & PROFINET International (PI) website at <http://www.profibus.com>. PROFINET-specific guidelines, profiles, presentations, brochures and software are available in the corresponding download area.

Information concerning the Siemens TIA Portal

The most important information about the Siemens TIA Portal and additional documents, links and training courses can be found at

<http://www.industry.siemens.com/topics/global/en/tia-portal/pages/default.aspx>.

SD6 – Device description

A GSD file for easily integrating the drive controllers of the SD6 series into the respective system environment can be found in the STOBER download center <http://www.stoeber.de/en/downloads/>, search term GSD.

STOBER TIA Portal example projects – Programming acyclical communication services

STOBER-specific example projects along with the accompanying documentation for programming acyclical communication services in TIA Portal can be found in the STOBER download center <http://www.stoeber.de/en/downloads/> using the search term TIA Portal.

11.5 Abbreviations

Abbreviation	Meaning
BF	Busfehler (Bus error)
CBA	Component Based Automation
CPU	Central Processing Unit
DCP	Discovery and Configuration Protocol
DHCP	Dynamic Host Configuration Protocol
DP	Decentral peripherals
EMC	Electromagnetic Compatibility
GSD	General Station Description data
GSDML	General Station Description Markup Language
HMI	Human Machine Interface
HTTP	Hypertext Transfer Protocol
IEC	International Electrotechnical Commission
IEEE	Institute of Electrical and Electronics Engineers
I/O	Input/Output
IP	Internet Protocol
IRT	Isochronous Real-Time
LAN	Local Area Network
LSB	Least Significant Bit
MAC	Media Access Control
PG	Programmiergerät (programming device)
PROFIBUS	Process Field Bus
PROFINET	Process Field Network
PZD	Prozessdaten (process data)
RDREC	Read Record
RT	Real-Time
RxPZD	Receive PZD (receive process data)
SNMP	Simple Network Management Protocol
PLC	Programmable Logic Controller
TIA	Totally Integrated Automation
TCP	Transmission Control Protocol
TxPZD	Transmit PZD (transmit process data)
UDP	User Data Protocol
WRREC	Write Record

12 Contact

12.1 Consultation, service and address

We would be happy to help you!

We offer a wealth of information and services to go with our products on our website:

<http://www.stoeber.de/en/service>

For additional or personalized information, contact our consultation and support service:

<http://www.stoeber.de/en/support>

If you need our system support:

Phone +49 7231 582-3060

systemsupport@stoeber.de

If you need a replacement device:

Phone +49 7231 582-1128

replace@stoeber.de

Call our 24-hour service hotline:

Tel. +49 7231 582-3000

Our address:

STÖBER Antriebstechnik GmbH + Co. KG

Kieselbronner Strasse 12

75177 Pforzheim, Germany

12.2 Your opinion is important to us

We created this documentation to the best of our knowledge with the goal of helping you build and expand your expertise productively and efficiently with our products.

Your suggestions, opinions, wishes and constructive criticism help us to ensure and further develop the quality of our documentation.

If you want to contact us for a specific reason, we would be happy to receive an e-mail from you at:

documentation@stoeber.de

Thank you for your interest.

Your STÖBER editorial team

12.3 Close to customers around the world

We offer you committed, expert advice and support in over 40 countries worldwide:

STOBER AUSTRIA

www.stoerber.at
+43 7613 7600-0
sales@stoerber.at

STOBER FRANCE

www.stoerber.fr
+33 478 98 91 80
sales@stoerber.fr

STOBER HUNGARY

www.stoerber.de
+36 53 5011140
info@emtc.hu

STOBER JAPAN

www.stoerber.co.jp
+81-3-5875-7583
sales@stoerber.co.jp

STOBER TAIWAN

www.stoerber.tw
+886 4 2358 6089
sales@stoerber.tw

STOBER UK

www.stoerber.co.uk
+44 1543 458 858
sales@stoerber.co.uk

STOBER CHINA

www.stoerber.cn
+86 512 5320 8850
sales@stoerber.cn

STOBER Germany

www.stoerber.de
+49 4 7231 582-0
sales@stoerber.de

STOBER ITALY

www.stoerber.it
+39 02 93909570
sales@stoerber.it

STOBER SWITZERLAND

www.stoerber.ch
+41 56 496 96 50
sales@stoerber.ch

STOBER TURKEY

www.stoerber.com
+90 216 510 2290
sales-turkey@stoerber.com

STOBER USA

www.stoerber.com
+1 606 759 5090
sales@stoerber.com

Glossary

100Base-TX

Ethernet network standard based on symmetrical copper cables in which the nodes are connected to a switch via copper cables twisted in pairs (shielded twisted pair, CAT 5e quality level). 100Base-TX is the subsequent progression from 10Base-T and includes those properties with the option of a transfer speed of 100 Mbps (Fast Ethernet).

Broadcast domain

Logical grouping of network devices within a local network that reaches all nodes via broadcast.

GSD file

Includes the technical features of a PROFINET IO device (type, configuration data, parameters, diagnostic information, etc.) in XML format in accordance with the GSDML specification. A GSD file serves as the configuration basis for project configuration systems and is generally provided by the respective device manufacturer.

i²t model

Computational model for thermal monitoring.

IO controller

Generally, a programmable logic controller that controls automation tasks and regulates data communication.

IO device

A decentralized field device that is assigned logically to a PROFINET IO controller that manages and controls it. An IO device consists of multiple modules and submodules.

IO supervisor

Generally, engineering software that can access all process and configuration data. An IO supervisor is only engaged temporarily for parameterizing the IO devices, commissioning the IO system and for diagnostic purposes.

IPv4 limited broadcast

Type of broadcast in a network with IPv4 (Internet Protocol version 4). The IP address 255.255.255.255 is entered as the destination. The content of the broadcast is not forwarded by a router, which limits it to the local network.

MAC address

Hardware address for unique identification of a device in an Ethernet network. The MAC address is assigned by the manufacturer and consists of a 3-byte manufacturer ID and 3-byte device ID.

Process data (PZD)

Control and status information that is time-critical and transmitted in the PROFINET network cyclically using telegrams. Depending on the view of the respective node, a distinction is made between receive PZD (RxPZD) and transmit PZD (TxPZD).

PROFINET

Open Ethernet standard of PROFIBUS Nutzerorganisation e. V. (PNO) for automation.

PROFINET RT

Transmission method for time-critical process data in a PROFINET IO system.

Receive PZD (RxPZD)

Process data received by a node in the PROFINET network.

System function block (Siemens)

Logic block as part of a distributed, structured Siemens user program used to call up important system functions for PROFINET IO. Parameters for the associated input and output interfaces can be configured individually. The variable values stored in a function block are saved and are not lost after processing. Typical Siemens system function blocks are WRREC (Write record) and RDREC (Read record).

TCP/IP

Protocol family composed of the transmission control protocol (TCP) and the Internet protocol (IP). TCP is responsible for transmission, i.e. actual data traffic; IP handles unique communication with a PC in a network.

Transmit PZD (TxPZD)

Process data sent by a node.

UDP/IP

Minimalist transport protocol for networks such as LAN that only provides the essential functions for data transport. UDP/IP is a simple service that functions without a continuous connection on both sides. There is no connection or disconnection and no acknowledgment of the received data packets. There is the option to control data traffic using a checksum. As with TCP/IP, there are no troubleshooting mechanisms. Therefore, it is entirely possible for the transferred data to experience data loss, data duplication or sequence errors.

List of figures

Fig. 1	PROFINET: Network structure	11
Fig. 2	DS6: Program interface	15
Fig. 3	DriveControlSuite: Navigation using text links and symbols	17
Fig. 4	TIA Portal: Program interface of the portal view	18
Fig. 5	TIA Portal: Program interface of the project view	19
Fig. 6	PROFINET: Connection monitoring	50
Fig. 7	LEDs for the PROFINET state	51
Fig. 8	LEDs for the state of the PROFINET network connection	52
Fig. 9	RDREC system function block: Input and output parameters	60
Fig. 10	WRREC system function block: Input and output parameters	61
Fig. 11	RDREC flow	62
Fig. 12	WRREC flow	62
Fig. 13	PROFINET communication protocols	64
Fig. 14	Overview of fieldbus scaling	69

List of tables

Tab. 1	Correlation of STOBER terminology to PROFINET	9
Tab. 2	X200 and X201 connection description.....	13
Tab. 3	Parameter groups.....	20
Tab. 4	Parameters: Data types, parameter types, possible values	21
Tab. 5	Parameter types	22
Tab. 6	Meaning of the red LED (BF)	51
Tab. 7	Meaning of the green LED (Run)	51
Tab. 8	Meaning of the green LEDs (Link)	52
Tab. 9	Meaning of the yellow LEDs (Act.)	52
Tab. 10	Event 52 – Causes and actions	54
Tab. 11	Parameters of the RDREC system function block.....	60
Tab. 12	Parameters of the WRREC system function block.....	61
Tab. 13	Cycle times	66
Tab. 14	Selecting and executing an action.....	68
Tab. 15	Fieldbus scaling for integer: Parameters for defining the decimal places.....	69
Tab. 16	Groups and parameters	70
Tab. 17	WRREC: RECORD request: Header structure.....	71
Tab. 18	RDREC: RECORD response: Header structure	72
Tab. 19	RDREC, WRREC: Error codes.....	73
Tab. 20	Attribute, format: Possible combinations	74
Tab. 21	Process data modules	75



4 4 2 7 1 0 . 0 5

08/2024

STÖBER Antriebstechnik GmbH + Co. KG
Kieselbronner Str. 12
75177 Pforzheim
Germany
Tel. +49 7231 582-0
mail@stoeber.de
www.stober.com

24 h Service Hotline
+49 7231 582-3000

www.stober.com